

WIREMOLD



Pancake® Overfloor Steel Raceway

1500, 2600 Overfloor Raceway

Deal for open space wiring of workstations and desk areas in high traffic sites. Steel Pancake raceway mounts directly to the floor and provides safe load bearing strength for normal office use. Both raceways offer a full complement of fittings and device boxes for power and communication wiring. Steel Pancake raceway comes unpainted with a paintable galvanized finish.

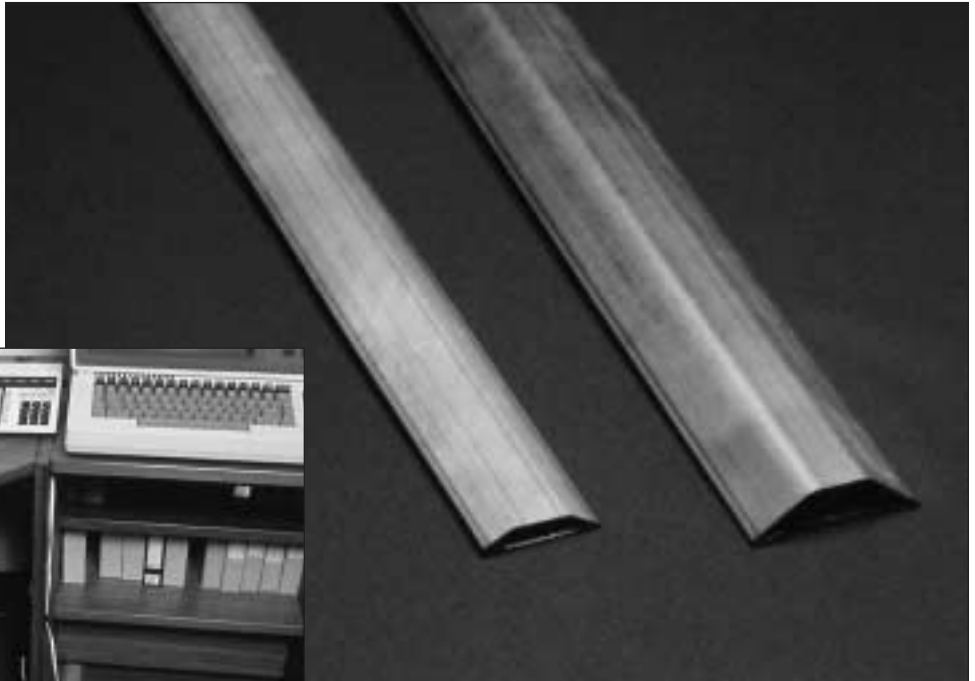

1500 and 2600 Overfloor Raceway provide solutions for bringing power or voice/data to open space design.

Features & Benefits

- **Installs in open space areas.** Brings power or telephone and signal wiring to away-from-wall locations.
- **Flat profile.** Unobtrusive, low-profile appearance.
- **Galvanized steel.** Assures durability.
- **2600 Series withstands approximately 150 lbs./sq in.** Provides safe load bearing strength for normal office traffic.
- **1500 Series withstands approximately 200 lbs./sq in.** Provides safe load strength for normal office traffic.
- **Full line of fittings.** Provides a complete and safe installation.
- **Unpainted.** Paintable to match decor.
- **UL Listed and CSA certified.** File E4376 Guide RJBT fittings. File 41751 Guide RJPR. CSA File 350.
- **UL5.** Raceway is compliant with UL5 specifications.

2600 Base and Cover

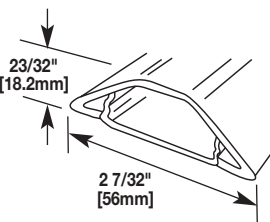
Catalog No./Item	Description/Specifications
2600	<p>Base and Cover – Cover: .050" [1.25mm] galvanized steel. Base: .040" [1mm] galvanized steel. Packed (5) 10 ft. [3.050m] lengths per carton. Base has 9/32" [7.1mm] dia. mounting holes on centers of approximately 8" [203mm].</p> 

2600 Overfloor Raceway Fittings

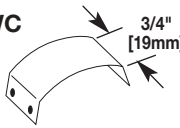
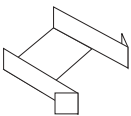
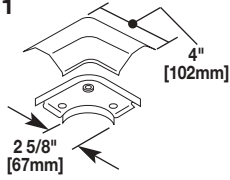
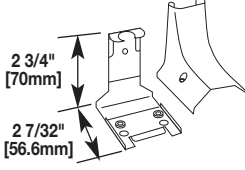
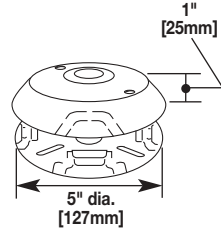
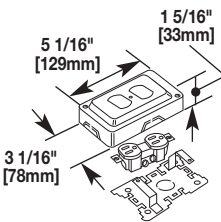
Catalog No./Item	Description/Specifications
2600WC	<p>Wire Clip – For holding conductors in place.</p> 
2602	<p>Fiber Bushing – Protects wires from abrasion. Bushing slips into open end of 2600 where it enters a fitting.</p> 
2611	<p>90° Flat Elbow – For right angle turns on same surface.</p> 
2617T	<p>Telephone Elbow – Used at beginning of run at wall, at end of run, and along run (two fittings back to back, with backs removed at score) where cable is brought out and back to continue run. Cover has two twistouts and base is scored for quarter-round baseboard molding. Max. Capacity: two 25 pr. telephone cables. Not UL Listed.</p> 
2642D	<p>Junction Box – May be used with 1500 and/or 2600 as a cross, tee, or elbow. Cover has 1/2" [12.7mm] trade size KO. Base has 1/2" [12.7mm] and 3/4" [19mm] concentric KO to enable connection to floor, outlet boxes, or under floor duct systems (use chase nipple – not included). Two 2600WC wire clips included.</p> 
1543GL	<p>Grounding Duplex – Cover has 1500 and 2600 twistouts on all four sides. Base has 1/2" [12.7mm] and 3/4" [19mm] concentric KOs. Two 1500WC Wire Clips included.</p> 

2600 Overfloor Raceway Fittings

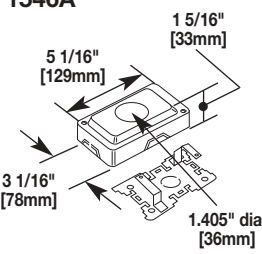
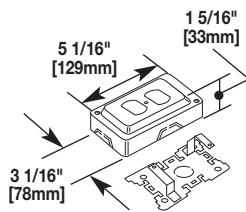
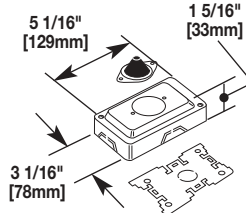
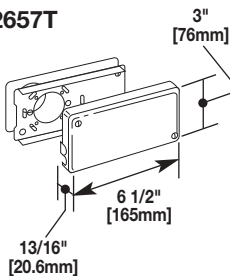
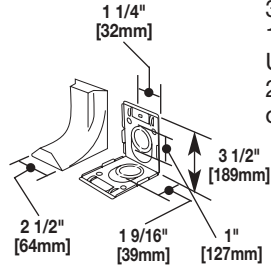
Catalog No./Item	Description/Specifications
1546A	<p>Single Receptacle Box – Accommodates commercially available straight blade and locking single receptacles with face diameters of 1.38-1.40" [34.5-35mm]. Base has 1/2" [12.7mm] and 3/4" [19mm] trade size concentric KOs. Cover has 1500 and 2600 twistouts on all four sides. Two 1500WC wire clips included.</p> 
1546B	<p>Duplex Receptacle Box – Accommodates commercially available 15A or 20A duplex receptacles. Base has 1/2" [12.7mm] and 3/4" [19mm] concentric trade size KOs. Cover has 1500 and 2600 twistouts on all four sides. Two 1500WC wire clips included. Side wiring recommended.</p> 
1546T	<p>Telephone Outlet Box – Furnished with 1/2" [12.7mm] rubber stem. Accepts modular connecting blocks within the fitting. Cover has 1500 and 2600 twistouts on both ends and both sides. Two 1500WC wire clips included. Not UL Listed.</p> 
2657T	<p>Telephone Service Fitting – Cover has 1500 and 2600 twistouts on one end. Use to house 25 pr. telephone connector. Two rubber grommets furnished. Holecut base enables mounting to 4" [102mm] wall box. Not UL Listed.</p> 
2186	<p>Adjustable Offset – Has twistouts for 2100 and 2600 on each end. Base has Connector 3/4" [19mm], 1" [25mm] and 1" [25mm] elongated knockouts. Use for 90° internal corners for 2600, transition from 2600 to 2100, or for connection to panel boxes.</p> 

1500 Raceway Wire Fill Capacities for Power

	WIRE SIZE THHN/THWN	O.D.		40% FILL
		inches	[mm]	
POWER WIRING	8 AWG	0.218	[5.5]	2
	10 AWG	0.153	[3.9]	5
	12 AWG	0.122	[3.1]	8
	14 AWG	0.105	[2.7]	10

1500 Raceway Wire Fill Capacities for Communications

	CABLE/WIRE SIZE	O.D.		20% FILL	40% FILL
		inches	[mm]		
UNSHIELDED TWISTED PAIR	4-Pair, 24 AWG Cat 5 UTP	0.210	[5.3]	1	2
	4-Pair, 24 AWG Cat 3 UTP	0.190	[4.8]	1	3
TELEPHONE	2-Pair, 24 AWG	0.150	[3.8]	3	6
	3-Pair, 24 AWG	0.160	[4.1]	2	5
	4-Pair, 24 AWG	0.190	[4.8]	1	3
	25-Pair, 24 AWG	0.360	[9.1]	0	0
COAXIAL	RG58/U	0.195	[5.0]	1	3
	RG59/U	0.242	[6.1]	1	2
	RG62/U	0.242	[6.1]	1	2
	RG6/U	0.270	[6.9]	0	1
TWINAXIAL	100 Ohm	0.330	[8.4]	0	1
SHIELD TWISTED PAIR	Type 1	0.390	[9.9]	0	0
	Type 2	0.465	[11.8]	0	0
	Type 3	0.245	[6.2]	0	2
FIBER OPTIC	Two Stranded (Duplex) Multimode, 62.5/125 µm	0.190	[4.8]	1	3

2600 Raceway Wire Fill Capacities for Power

	WIRE SIZE THHN/THWN	O.D.		40% FILL
		inches	[mm]	
POWER WIRING	8 AWG	0.218	[5.5]	8
	10 AWG	0.153	[3.9]	16
	12 AWG	0.122	[3.1]	25
	14 AWG	0.105	[2.7]	33

2600 Raceway Wire Fill Capacities for Communications

	CABLE/WIRE SIZE	O.D.		20% FILL	40% FILL
		inches	[mm]		
UNSHIELDED TWISTED PAIR	4-Pair, 24 AWG Cat 5 UTP	0.210	[5.6]	3	7
	4-Pair, 24 AWG Cat 3 UTP	0.190	[4.8]	5	10
TELEPHONE	2-Pair, 24 AWG	0.150	[3.3]	9	18
	3-Pair, 24 AWG	0.160	[4.1]	8	16
	4-Pair, 24 AWG	0.190	[4.8]	5	10
	25-Pair, 24 AWG	0.360	[9.1]	1	2
COAXIAL	RG58/U	0.195	[5.0]	4	9
	RG59/U	0.242	[6.1]	3	6
	RG62/U	0.242	[6.1]	3	6
	RG6/U	0.270	[6.9]	2	5
TWINAXIAL	100 Ohm	0.330	[8.4]	1	3
SHIELD TWISTED PAIR	Type 1	0.390	[9.9]	1	2
	Type 2	0.465	[11.8]	0	1
	Type 3	0.245	[6.2]	3	6
FIBER OPTIC	Two Stranded (Duplex) Multimode, 62.5/125 µm	0.190	[4.8]	5	10

*20% cable fill is calculated to approximate reduction in cable capacity due to connectors mounted within raceway and fittings that may restrict cross sectional area.

**40% cable fill is the maximum designed cable fill based on a proposed revision to TIA/EIA 569-A.

WIREMOLD

 legrand®