

Inductive Sensors

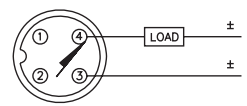
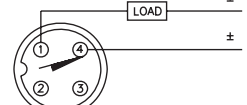
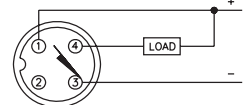
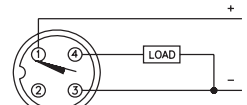
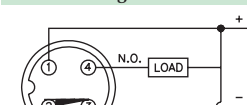
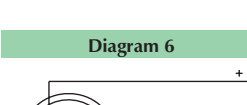
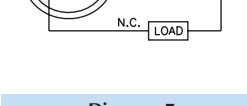
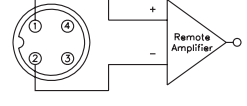

Housing Style	Part Number	ID Number	Features	Sensing Range (mm)	Output	
12 mm - Nonembeddable, eurofast® Connection 	Ni 4-M12-AD4X-H1141	T4406700		4	2-Wire DC	
	Ni 4-M12-AD4X-H1144	M4406701		4		
	Ni 8-M12-AD4X-H1141	T4411241	<i>Ext. Range</i>	8		
	Ni 8-M12-AD4X-H1144	T4411289	<i>Ext. Range</i>	8		
	Ni 4-EM12-AN7X-H1141	T4606893	<i>TTL Compatible</i>	4	3-Wire DC NPN	
	Ni 4-M12-AN6X-H1141	T4606800		4		
	Ni 5-EM12WD-AN6X-H1141	M4653431	<i>Washdown</i>	5		
	Ni 5-M12-AN6X-H1141	T4671390		5		
	Ni 8-M12-AN6X-H1141	T4611315	<i>Ext. Range</i>	8		
	Ni 8U-EM12-AN6X-H1141	M1644350	<i>Uprox</i>	8		
	Ni 8U-M12-AN6X-H1141	M1644150	<i>Uprox</i>	8		
	Ni 8U-M12-AN6X2-H1141	M1644155	<i>Uprox, Dual LED</i>	8		
	Ni 4-M12-AP6X-H1141	T4606700		4	3-Wire DC PNP	
	Ni 5-EM12WD-AP6X-H1141	M1634331	<i>Washdown</i>	5		
	Ni 5-M12-AP6X-H1141	T4653400		5		
	Ni 8-M12-AP6X-H1141	T4611310	<i>Ext. Range</i>	8		
	Ni 8U-EM12-AP6X-H1141	M1644340	<i>Uprox</i>	8		
	Ni 8U-M12-AP6X-H1141	M1644140	<i>Uprox</i>	8		
	Ni 8U-M12-AP6X2-H1141	M1644145	<i>Uprox, Dual LED</i>	8		
	Ni 4-M12-VN6X-H1141	T1643100	<i>Comp. Output</i>	4	4-Wire DC NPN	
	Ni 8-M12-VN6X-H1141	T4611323	<i>Ext. Range, Comp. Output</i>	8		
	Ni 4-EM12-VP6X-H1141	M1633101	<i>Comp. Output</i>	4	4-Wire DC PNP	
	Ni 4-M12-VP6X-H1141	T1633100	<i>Comp. Output</i>	4		
	Ni 8-M12-VP6X-H1141	T4611324	<i>Ext. Range, Comp. Output</i>	8		
	Ni 5-M12-Y1X-H1141	M4010300			5	2-Wire DC NAMUR

Voltage	Switching Freq. (Hz)	Operating Current (mA)	Operating Temp. (°C)	Protection	Housing	Face	Power LED	Output LED	Mating Cordset	Wiring Diagram #	Wiring Diagrams
10-65 VDC	2000	≤100	-25 to +70	IP 67	CPB	PA 12	N/A	YE	RK 4.2T-*	1	<p>Diagram 1</p> 
	2000	≤100	-25 to +70	IP 67	CPB	PA 12	N/A	YE	RK 4.2T-*/S674	2	
	2000	≤100	-25 to +70	IP 67	CPB	PA 12	N/A	YE	RK 4.2T-*	1	
	2000	≤100	-25 to +70	IP 67	CPB	PA 12	N/A	YE	RK 4.2T-*/S674	2	
10-30 VDC	2000	≤200	-25 to +70	IP 67	CPB	PA 12	N/A	YE	RKV 4T-*	3	<p>Diagram 2</p>  <p>Diagram 3</p> 
	2000	≤200	-25 to +70	IP 67	CPB	PA 12	N/A	YE	RK 4T-*	3	
	1500	≤200	-25 to +85	IP 68, 69K	SS	PVDF	N/A	YE	RK 4T-*	3	
	2000	≤200	-25 to +70	IP 67	CPB	PA 12	N/A	YE	RK 4T-*	3	
	2000	≤200	-25 to +70	IP 67	CPB	PA 12	N/A	YE	RK 4T-*	3	
	2000	≤200	-30 to +85	IP 68	SS	PA 12	N/A	YE	RKV 4T-*	3	
	2000	≤200	-30 to +85	IP 67	CPB	PA 12	N/A	YE	RK 4T-*	3	
10-30 VDC	2000	≤200	-25 to +70	IP 67	CPB	PA 12	N/A	YE	RK 4T-*	4	<p>Diagram 4</p>  <p>Diagram 5</p> 
	1500	≤200	-25 to +85	IP 68, 69K	SS	PVDF	N/A	YE	RK 4T-*	4	
	2000	≤200	-25 to +70	IP 67	CPB	PA 12	N/A	YE	RK 4T-*	4	
	2000	≤200	-25 to +70	IP 67	CPB	PA 12	N/A	YE	RK 4T-*	4	
	2000	≤200	-30 to +85	IP 68	SS	PA 12	N/A	YE	RKV 4T-*	4	
	2000	≤200	-30 to +85	IP 67	CPB	PA 12	N/A	YE	RK 4T-*	4	
	2000	≤200	-30 to +85	IP 67	CPB	PA 12	GN	YE	RK 4T-*	4	
10-30 VDC	2000	≤200	-25 to +70	IP 67	CPB	PA 12	N/A	YE	RK 4.4T-*	5	<p>Diagram 6</p> 
	2000	≤200	-25 to +70	IP 67	CPB	PA 12	N/A	YE	RK 4.4T-*	5	
10-30 VDC	2000	≤200	-25 to +70	IP 67	SS	PA 12	N/A	YE	RKV 4.4T-*	6	<p>Diagram 7</p> 
	2000	≤200	-25 to +70	IP 67	CPB	PA 12	N/A	YE	RK 4.4T-*	6	
	2000	≤200	-25 to +70	IP 67	CPB	PA 12	N/A	YE	RK 4.4T-*	6	
5-30 VDC	2000	Remote	-25 to +70	IP 67	CPB	PA 12	N/A	YE	RK 4.21T-*	7	<p>Diagram 7</p> 

* Length in meters.

WIRING DIAGRAM

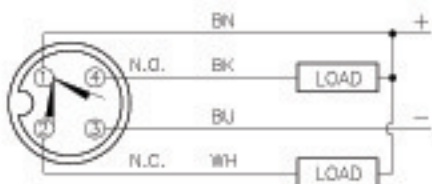

OUTPUT: VP6X

SHORT-CIRCUIT AND OVERLOAD PROTECTED

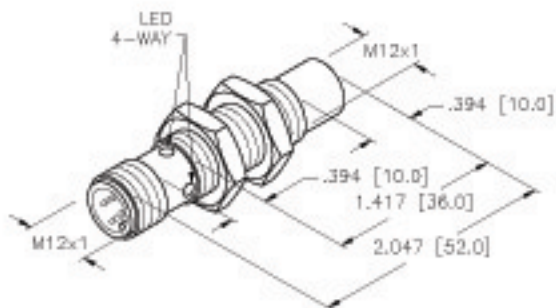

SPECIFICATIONS

OPERATING VOLTAGE	10-30 VDC
HYSTERESIS (DIFFERENTIAL TRAVEL)	3-15% (5% TYPICAL)
VOLTAGE DROP ACROSS CONDUCTING SENSOR	≤1.8 V at 200 mA
OUTPUT FUNCTION	COMPLEMENTARY OUTPUT ONE N.O., ONE N.C. (SPDT)
TTL COMPATIBLE	NO
SHORT-CIRCUIT PROTECTED	YES
TRIGGER CURRENT FOR OVERLOAD PROTECTION	≥ 220 mA
CONTINUOUS LOAD CURRENT	≤ 200 mA
OFF-STATE (LEAKAGE) CURRENT	<100 μA
NO-LOAD CURRENT	≤ 10 mA
TIME DELAY BEFORE AVAILABILITY	≤ 8 ms
POWER-ON EFFECT	Per IEC 947-5-2
REVERSE POLARITY PROTECTION	INCORPORATED
WIRE-BREAK PROTECTION	INCORPORATED
TRANSIENT PROTECTION	Per EN 60947-5-2
OPERATING TEMPERATURE	-25°C to +70°C (-13°F to +158°F)
ENCLOSURE	MEETS NEMA 1, 3, 4, 6, 13 AND IEC IP67
SHOCK	30 g, 11 ms
VIBRATION	55 Hz, 1 mm AMPLITUDE (IN ALL 3 PLANES)
LED FUNCTION	YELLOW: OUTPUT ENERGIZED
RATED OPERATING DISTANCE(Sn)	8 mm = 0.315" (NOMINAL)
SWITCHING FREQUENCY	2000 Hz
REPEATABILITY	≤ 2% OF RATED OPERATING DISTANCE
TEMPERATURE DRIFT	<-15%/+10%
EMBEDDABLE (SHIELDED)	NO
LOCKNUT M12x1	17 mm AF, 19.5 mm AC, 4.0 mm THK
MATING PLUGS/CABLES	4-PIN "EUROFAST" CONSTRUCTION

NOTE
PRELIMINARY
SPECIFICATIONS

SOURCE DRAWING - FOR REFERENCE ONLY

NOTE:

MATERIAL:

BARREL - CHROME PLATED BRASS
LOCKNUTS - CHROME PLATED BRASS
CONNECTOR - CHROME PLATED BRASS
SENSING FACE - PA12-QF30 PLASTIC

RELATED DOCUMENTS 1. 2. 3. 4.	3RD ANGLE PROJECTION 	THIS DOCUMENT IS PROPERTY OF TURCK INC. USE OF THIS DOCUMENT WITHOUT WRITTEN PERMISSION IS PROHIBITED.	TURCK INC High Technology Sensors and Automation Controls	
MATERIAL SEE NOTE	TOLERANCES UNLESS OTHERWISE SPECIFIED ±0.0394 in [±1.00 mm]	DRP-1 IK	DATE 03/14/01	DESCRIPTION Ni 8-M12-VP6X-H1141
FINISH SEE NOTE		OSGN	SCALE 1=1.5	
		UNIT OF MEASUREMENT NCH [MILLIMETER]		IDENTIFICATION NO. T4611324
		DO NOT SCALE THIS DRAWING		REV P1
P1	IK	03/14/01		
REV	DESCRIPTION	BY	DATE	ECO NO.
			FILE: T4611324	SHEET 1 OF 1