

Inductive Sensors

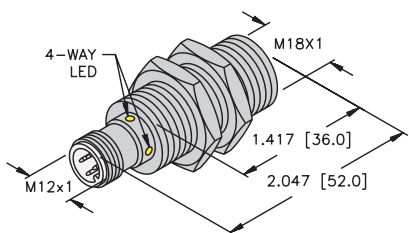
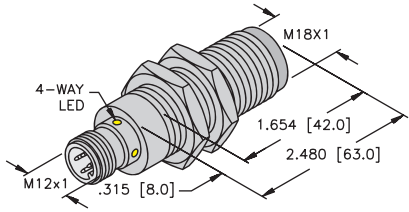
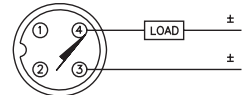
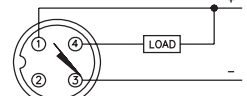
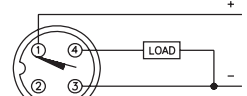
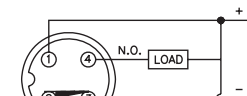
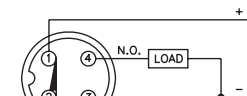
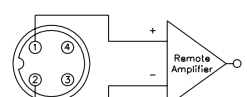
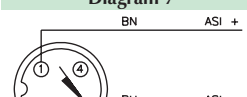
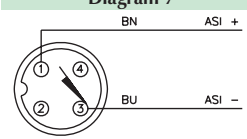

Housing Style	Part Number	ID Number	Features	Sensing Range (mm)	Output
18 mm - Embeddable eurofast® Connection 	Bi 5-M18-AD4X-H1141	T4414500		5	2-Wire DC
	Bi 7-M18-AD4X-H1141	T4414541	<i>Extended Range</i>	7	
	Bi 5-EM18-AN6X-H1141	T4614601		5	3-Wire DC NPN
	Bi 5-M18-AN6X-H1141	T4614600		5	
	Bi 5U-EM18-AN6X-H1141	M1635350	<i>Uprox</i>	5	
	Bi 5U-M18-AN6X-H1141	M1635150	<i>Uprox</i>	5	
	Bi 7-EM18WD-AN6X-H1141	M4614534	<i>Washdown</i>	7	
	Bi 8-M18-AN6X-H1141	T4615100	<i>Extended Range</i>	8	
	Bi 5U-M18-ASIX-H1140	M1901004	<i>Uprox</i>	5	2-Wire ASI-BUS
	Bi 5-EM18-AP6X-H1141	T4614501		5	3-Wire DC PNP
	Bi 5-M18-AP6X-H1141	T4614500		5	
	Bi 5U-EM18-AP6X-H1141	M1635340	<i>Uprox</i>	5	
	Bi 5U-M18-AP6X-H1141	M1635140	<i>Uprox</i>	5	
	Bi 7-EM18WD-AP6X-H1141	M4614531	<i>Washdown</i>	7	
	Bi 7-M18WD-AP6X-H1141	M4614529	<i>Washdown</i>	7	
	Bi 8-M18-AP6X-H1141	T4615000	<i>Ext. Range</i>	8	
	Bi 8-EM18H-AP6X-H1141	T4615094	<i>Ext. Range</i>	8	
	Bi 8-EM18H-AP6X-H1141/S1589	T4615099	<i>weldguard</i>	8	
	Bi 5-EM18-VN4X-H1141	T4614699	<i>Comp. Output</i>	5	4-Wire DC NPN
	Bi 5-M18-VN4X-H1141	T1571800	<i>Comp. Output</i>	5	
	Bi 8-M18-VN4X-H1141	T4590702	<i>Ext. Range</i>	8	4-Wire DC PNP
	Bi 5-M18-VP4X-H1141	T1561800	<i>Comp. Output</i>	5	
	Bi 8-M18-VP4X-H1141	T4590701	<i>Ext. Range</i>	8	4-Wire DC PNP
	Bi 5-M18-Y1X-H1141	M4015200		5	2-Wire NAMUR
18 mm - Embeddable eurofast Connection, Stainless Steel 	Bi 5-EM18FM-AP6X-H1141	M4614539	<i>Stainless Steel Front Cap</i>	5	3-Wire DC PNP

Voltage	Switching Freq. (Hz)	Operating Current (mA)	Operating Temp. (°C)	Protection	Housing	Face	Power LED	Output LED	Mating Cordset	Wiring Diagram #	Wiring Diagrams
10-65 VDC	1000	≤100	-25 to +70	IP 67	CPB	PA 12	N/A	YE	RK 4.2T-*	1	Diagram 1 
	1000	≤100	-25 to +70	IP 67	CPB	PA 12	N/A	YE	RK 4.2T-*	1	
10-30 VDC	1000	≤200	-25 to +70	IP 67	SS	PA 12	N/A	YE	RKV 4T-*	2	Diagram 2 
	1000	≤200	-25 to +70	IP 67	CPB	PA 12	N/A	YE	RK 4T-*	2	
	2500	≤200	-30 to +85	IP 68	SS	PA 12	N/A	YE	RKV 4T-*	2	
	2500	≤200	-30 to +85	IP 67	CPB	PA 12	N/A	YE	RKV 4T-*	2	
	1000	≤200	-25 to +85	IP 68, 69K	SS	PVDF	N/A	YE	RK 4T-*	2	
500	≤200	-25 to +70	IP 67	SS	PA 12	N/A	YE	RK 4T-*	2	2	
18-33 VDC	200	N/A	-30 to +85	IP 68	CPB	PA 12	N/A	YE	RKC 254-*M	7	Diagram 3 
10-30 VDC	1000	≤200	-25 to +70	IP 67	SS	PA 12	N/A	YE	RKV 4T-*	3	Diagram 4 
	1000	≤200	-25 to +70	IP 67	CPB	PA 12	N/A	YE	RK 4T-*	3	
	2500	≤200	-30 to +85	IP 68	SS	PA 12	N/A	YE	RKV 4T-*	3	
	2500	≤200	-30 to +85	IP 67	CPB	PA 12	N/A	YE	RK 4T-*	3	
	1000	≤200	-25 to +85	IP 68, 69K	SS	PVDF	N/A	YE	RK 4T-*	3	
	1000	≤200	-25 to +85	IP 68, 69K	CPB	PA 12	N/A	YE	RK 4T-*	3	
	500	≤200	-25 to +70	IP 67	SS	PA 12	N/A	YE	RK 4T-*	3	
	500	≤200	-25 to +70	IP 67	SS	SF	N/A	YE	RKV 4T-*	3	
500	≤200	-25 to +70	IP 67	SS	WG	N/A	YE	RKV 4T-*	3		
10-65 VDC	1000	≤200	-25 to +70	IP 67	SS	PA 12	N/A	YE	RKV 4.4T-*	4	Diagram 5 
	1000	≤200	-25 to +70	IP 67	CPB	PA 12	N/A	YE	RK 4.4T-*	4	
	500	≤200	-25 to +70	IP 67	SS	PA 12	N/A	YE	RK 4.4T-*	4	
10-65 VDC	1000	≤200	-25 to +70	IP 67	CPB	PA 12	N/A	YE	RK 4.4T-*	5	Diagram 6 
	500	≤200	-25 to +70	IP 67	SS	PA 12	N/A	YE	RK 4.4T-*	5	
5-30 VDC	1000	Remote	-25 to +70	IP 67	CPB	PA 12	N/A	YE	RK 4.21T-*	6	Diagram 7 
10-30 VDC	180	≤200	-25 to +80	IP 68, 69K	SS	SS	N/A	YE	RKV 4T-*	3	

* Length in meters.

WIRING DIAGRAM



OUTPUT: AP6X

LOCKNUT LN-M18

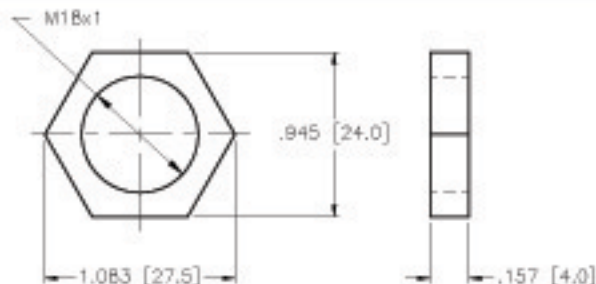

SPECIFICATIONS

OPERATING VOLTAGE	10-30 VDC
RIPPLE	≤10%
HYSTERESIS (DIFFERENTIAL TRAVEL)	3-15% (5% TYPICAL)
VOLTAGE DROP ACROSS CONDUCTING SENSOR	≤1.8 V at 200 mA
OUTPUT FUNCTION	NORMALLY OPEN 3-WIRE DC SELF-CONTAINED
TTL COMPATIBLE	NO
SHORT-CIRCUIT PROTECTED	YES
TRIGGER CURRENT FOR OVERLOAD PROTECTION	≥220 mA
CONTINUOUS LOAD CURRENT	≤200 mA
OFF-STATE (LEAKAGE) CURRENT	<10 μA
NO-LOAD CURRENT	5.5-9.5 mA
TIME DELAY BEFORE AVAILABILITY	≤8 ms
POWER-ON EFFECT	Per IEC 947-5-2
REVERSE POLARITY PROTECTION	INCORPORATED
WIRE-BREAK PROTECTION	INCORPORATED
TRANSIENT PROTECTION	Per EN 60947-5-2
OPERATING TEMPERATURE	-25°C to +70°C (-13°F to +158°F)
ENCLOSURE	MEETS NEMA 1, 3, 4, 6, 13 AND IEC IP67
SHOCK	30 g, 11 ms
VIBRATION	95 Hz, 1 mm AMPLITUDE (IN ALL 3 PLANES)
LED FUNCTION	YELLOW: OUTPUT ENERGIZED
RATED OPERATING DISTANCE(Sr)	5mm = 0.197" (NOMINAL)
SWITCHING FREQUENCY	1000 Hz
REPEATABILITY	≤2% of RATED OPERATING DISTANCE
SHIELDED	YES

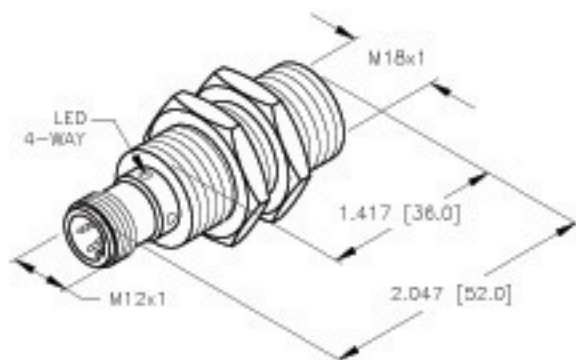

SOURCE DRAWING - FOR REFERENCE ONLY

NOTE: ALL TOLERANCES ±1.0 mm.

RELATED DOCUMENTS 1. 2. 3. 4.	3RD ANGLE PROJECTION 	THIS DRAWING IS PROPERTY OF TURCK INC. USE OF THIS DOCUMENT WITHOUT WRITTEN PERMISSION IS PROHIBITED.		TURCK INC High Technology Sensors and Automation Controls	
	MATERIAL BRASS BARREL	TOLERANCES UNLESS OTHERWISE SPECIFIED .X ±0.02 .XX ±0.01 .XXX ±0.005 ANGLES ±1° ALL MILLIMETER DIMENSIONS ARE REFERENCE ONLY	DWT SNW USDR	DATE 08/10/87 SCALE 1 = 1.5	DESCRIPTION Bi 5-M18-AP6X-H1141
FINISH COPPER/NICKEL/ CHROME PLATING	UNIT OF MEASUREMENT INCH [MILLIMETER]		IDENTIFICATION NO. T4614500		REV C
DO NOT SCALE THIS DRAWING		FILE: T4614500		SHEET 1 OF 1	

C	MODIFY DRAWING, NEW FORMAT	IK	03/08/00	T343B
REV	DESCRIPTION	BY	DATE	EDD NO.