

Inductive Sensors

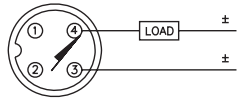
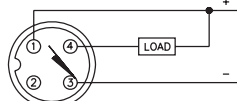
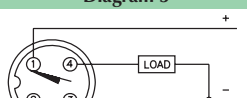
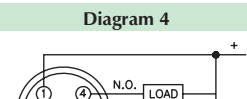
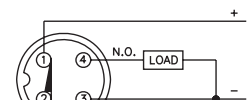
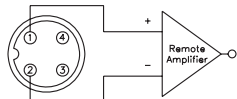
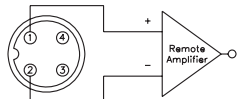
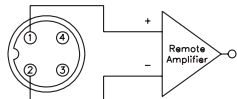

Housing Style	Part Number	ID Number	Features	Sensing Range (mm)	Output
12 mm - Embeddable, eurofast® Connection 	Bi 4-M12K-AN6X-H1141	T4607101	Short Barrel	4	3-Wire DC PNP
	Bi 4-M12K-AP6X-H1141	T4607082	Short Barrel	4	3-Wire DC PNP
	Bi 2-M12K-VP6X-H1141	M1633005	Short Barrel	2	4-Wire DC PNP
12 mm - Embeddable, eurofast Connection 	Bi 2-M12-AD4X-H1141	T4406500		2	2-Wire DC
	Bi 3-M12-AD4X-H1141	T4405041	Ext. Range	3	
	Bi 2-EM12-AN6X-H1141	T4606601		2	3-Wire DC NPN
	Bi 2-M12-AN6X-H1141	T4606600		2	
	Bi 3-EM12WD-AN6X-H1141	M1634334	Washdown	3	
	Bi 3-M12WD-AN6X-H1141	M4607120	Washdown	3	
	Bi 3U-EM12-AN6X-H1141	M1634350	Uprox	3	
	Bi 3U-M12-AN6X-H1141	M1634150	Uprox	3	
	Bi 3U-M12-AN6X2-H1141	M1634155	Uprox	3	
	Bi 4-M12-AN6X-H1141	T4607100	Extended Range	4	
	Bi 2-EM12-AP6X-H1141	T4606501		2	3-Wire DC PNP
	Bi 2-M12-AP6X-H1141	T4606500		2	
	Bi 3-EM12WD-AP6X-H1141	M1634331	Washdown	3	
	Bi 3-M12WD-AP6X-H1141	M4607121	Washdown	3	
	Bi 3U-EM12-AP6X-H1141	M1634340	Uprox	3	
	Bi 3U-EM12H-AP6X-H1141	M1634312	Uprox, Stoneface	3	
	Bi 3U-M12-AP6X-H1141	M1634140	Uprox	3	
	Bi 3U-M12-AP6X2-H1141	M1634145	Uprox	3	
	Bi 4-M12-AP6X-H1141	T4607000	Extended Range	4	
	Bi 2-M12-VN6X-H1141	T1643000	Comp. Outputs	2	
	Bi 4-M12-VN6X-H1141	T1643200	Ext. Range, Comp. Outputs	4	
	Bi 2-M12-VP6X-H1141	T1633000	Comp. Outputs	2	4-Wire DC PNP
	Bi 4-M12-VP6X-H1141	T1633200	Ext. Range, Comp. Outputs	4	
	Bi 4-EM12-VP6X-H1141	T1633201	Ext. Range, Comp. Outputs	4	
	Bi 2-EM12-Y0X-H1141	T4010098		2	2-Wire DC NAMUR
	Bi 2-M12-Y1X-H1141	M4010200		2	

Voltage	Switching Freq. (Hz)	Operating Current (mA)	Operating Temp. (°C)	Protection	Housing	Face	Power LED	Output LED	Mating Cordset	Wiring Diagram #	Wiring Diagrams
10-30 VDC	2000	≤200	-25 to +70	IP 67	CPB	PA 12	N/A	YE	RK 4T-*	2	Diagram 1
10-30 VDC	2000	≤200	-25 to +70	IP 67	CPB	PA 12	N/A	YE	RK 4T-*	3	
10-30 VDC	2000	≤200	-25 to +70	IP 67	CPB	PA 12	N/A	YE	RK 4.4T-*	5	Diagram 2
10-30 VDC	2000	≤200	-25 to +70	IP 67	CPB	PA 12	N/A	YE	RK 4.4T-*	5	
10-65 VDC	1000	≤100	-25 to +70	IP 67	CPB	PA 12	N/A	YE	RK 4.2T-*	1	Diagram 3
10-65 VDC	1000	≤100	-25 to +70	IP 67	CPB	PA 12	N/A	YE	RK 4.2T-*	1	
10-30 VDC	2000	≤200	-25 to +70	IP 67	SS	PA 12	N/A	YE	RKV 4T-*	2	
	2000	≤200	-25 to +70	IP 67	CPB	PA 12	N/A	YE	RK 4T-*	2	
	2000	≤200	-25 to +85	IP 68, 69K	SS	PVDF	N/A	YE	RK 4T-*	2	
	3000	≤200	-25 to +85	IP 68, 69K	SS	PVDF	N/A	YE	RK 4T-*	2	
	3000	≤200	-30 to +85	IP 68	SS	PA 12	N/A	YE	RKV 4T-*	2	
	3000	≤200	-30 to +85	IP 67	CPB	PA 12	N/A	YE	RK 4T-*	2	
	3000	≤200	-30 to +85	IP 67	CPB	PA 12	GN	YE	RK 4T-*	2	
2000	≤200	-25 to +70	IP 67	CPB	PA 12	N/A	YE	RK 4T-*	2		
10-30 VDC	2000	≤200	-25 to +70	IP 67	SS	PA 12	N/A	YE	RKV 4T-*	3	
	2000	≤200	-25 to +70	IP 67	CPB	PA 12	N/A	YE	RK 4T-*	3	
	2000	≤200	-25 to +85	IP 68, 69K	SS	PVDF	N/A	YE	RK 4T-*	3	
	3000	≤200	-25 to +85	IP 68, 69K	SS	PVDF	N/A	YE	RK 4T-*	3	
	3000	≤200	-30 to +85	IP 68	SS	PA 12	N/A	YE	RKV 4T-*	3	
	3000	≤200	-30 to +85	IP 68	SS	SF	N/A	YE	RKG 4T-*/S600	3	
	3000	≤200	-30 to +85	IP 67	CPB	PA 12	N/A	YE	RK 4T-*	3	
	3000	≤200	-30 to +85	IP 67	CPB	PA 12	N/A	YE	RK 4T-*	3	
2000	≤200	-25 to +70	IP 67	CPB	PA 12	N/A	YE	RK 4T-*	3		
10-30 VDC	2000	≤200	-25 to +70	IP 67	CPB	PA 12	N/A	YE	RK 4.4T-*	4	
	2000	≤200	-25 to +70	IP 67	CPB	PA 12	N/A	YE	RK 4.4T-*	4	
10-30 VDC	2000	≤200	-25 to +70	IP 67	CPB	PA 12	N/A	YE	RK 4.4T-*	5	
	2000	≤200	-25 to +70	IP 67	CPB	PA 12	N/A	YE	RK 4.4T-*	5	
	2000	≤200	-25 to +70	IP 67	SS	PA 12	N/A	YE	RKV 4.4T-*	5	
5-30 VDC	5000	Remote	-25 to +70	IP 67	SS	PA 12	N/A	YE	RKV 4.21T-*	6	
	5000	Remote	-25 to +70	IP 67	CPB	PA 12	N/A	YE	RK 4.21T-*	6	

* Length in meters.

WIRING DIAGRAM

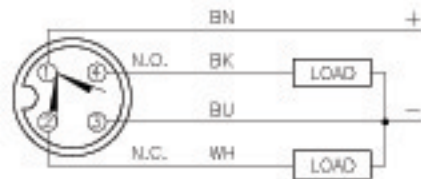

OUTPUT: VP6X

LOCKNUT LN-M12

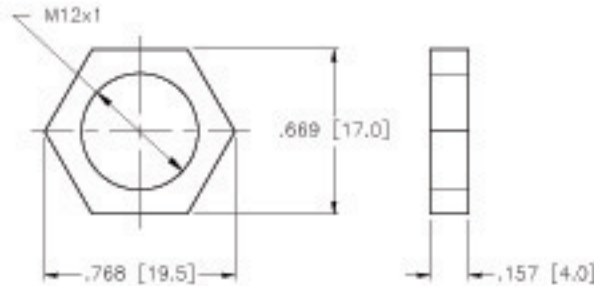

SPECIFICATIONS

RATED OPERATING DISTANCE	4 mm [.158]
MOUNTING MODE	FLUSH
TEMPERATURE DRIFT	±10%
HYSTERESIS (SWITCHING DISTANCE)	3-15%
MIN. REPEAT ACCURACY	±2%
OPERATING TEMPERATURE	-25°C to +70°C (-13°F to +158°F)
RATED OPERATIONAL VOLTAGE	10-30 VDC
MAX. RIPPLE	±10%
RATED OPERATIONAL CURRENT	≤200 mA
NO-LOAD CURRENT	≤15 mA
MAX. OFF-STATE CURRENT	≤0.1 mA
RATED INSULATION VOLTAGE	≤0.5 kV
SHORT-CIRCUIT PROTECTED	YES
MAX. VOLTAGE DROP	≤1.8 V
WIRE-BREAK PROTECTION	INCORPORATED
REVERSE POLARITY PROTECTION	INCORPORATED
OUTPUT FUNCTION	4-WIRE, COMPLIMENTARY, PNP
MAX. SWITCHING FREQUENCY	≤2 kHz
HOUSING MATERIAL	BRASS, CHROME PLATED
ACTIVE FACE	PLASTIC, PA12-GF30
CONNECTOR	M12x1 EUROFAST
VIBRATION RESISTANCE	55 Hz (IN ALL 3 PLANES)
SHOCK RESISTANCE	30 g, 11 ms
DEGREE OF PROTECTION	IP 67
SWITCHING STATUS INDICATION	LED, YELLOW

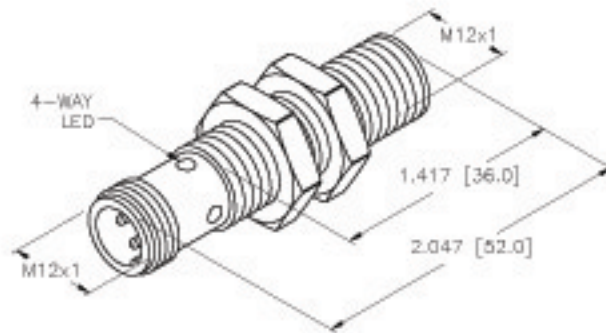

RELATED DOCUMENTS 1. 2. 3. 4.	3RD ANGLE PROJECTION 	THIS DRAWING IS PROPERTY OF TURCK INC. USE OF THIS DOCUMENT WITHOUT WRITTEN PERMISSION IS PROHIBITED.		TURCK INC High Technology Sensors and Automation Controls	
	MATERIAL	TOLERANCES UNLESS OTHERWISE SPECIFIED	DRFT RDS	DATE 09/21/04	DESCRIPTION BI 4-M12-VP6X-H1141
FINISH	±0.0394 in [±1.00 mm]	USDR	SCALE 1=1.0	IDENTIFICATION NO. T1633200	REV A
UNIT OF MEASUREMENT INCH [MILLIMETER]		DO NOT SCALE THIS DRAWING		FILE: T1633200	SHEET 1 OF 1
A	DRAWING RELEASE	RDS	09/22/04		
REV	DESCRIPTION	BY	DATE	EDD NO.	