

Inductive Sensors

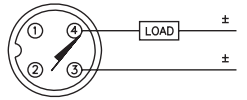
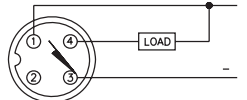
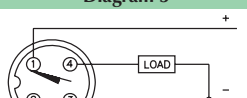
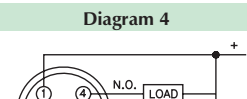
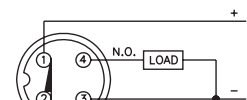
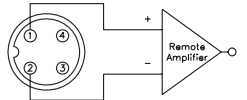
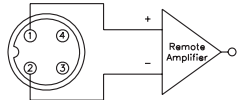
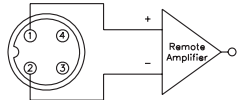

Housing Style	Part Number	ID Number	Features	Sensing Range (mm)	Output
12 mm - Embeddable, eurofast® Connection 	Bi 4-M12K-AN6X-H1141	T4607101	Short Barrel	4	3-Wire DC PNP
	Bi 4-M12K-AP6X-H1141	T4607082	Short Barrel	4	3-Wire DC PNP
	Bi 2-M12K-VP6X-H1141	M1633005	Short Barrel	2	4-Wire DC PNP
12 mm - Embeddable, eurofast Connection 	Bi 2-M12-AD4X-H1141	T4406500		2	2-Wire DC
	Bi 3-M12-AD4X-H1141	T4405041	Ext. Range	3	
	Bi 2-EM12-AN6X-H1141	T4606601		2	3-Wire DC NPN
	Bi 2-M12-AN6X-H1141	T4606600		2	
	Bi 3-EM12WD-AN6X-H1141	M1634334	Washdown	3	
	Bi 3-M12WD-AN6X-H1141	M4607120	Washdown	3	
	Bi 3U-EM12-AN6X-H1141	M1634350	Uprox	3	
	Bi 3U-M12-AN6X-H1141	M1634150	Uprox	3	
	Bi 3U-M12-AN6X2-H1141	M1634155	Uprox	3	
	Bi 4-M12-AN6X-H1141	T4607100	Extended Range	4	
	Bi 2-EM12-AP6X-H1141	T4606501		2	3-Wire DC PNP
	Bi 2-M12-AP6X-H1141	T4606500		2	
	Bi 3-EM12WD-AP6X-H1141	M1634331	Washdown	3	
	Bi 3-M12WD-AP6X-H1141	M4607121	Washdown	3	
	Bi 3U-EM12-AP6X-H1141	M1634340	Uprox	3	
	Bi 3U-EM12H-AP6X-H1141	M1634312	Uprox, Stoneface	3	
	Bi 3U-M12-AP6X-H1141	M1634140	Uprox	3	
	Bi 3U-M12-AP6X2-H1141	M1634145	Uprox	3	
	Bi 4-M12-AP6X-H1141	T4607000	Extended Range	4	
	Bi 2-M12-VN6X-H1141	T1643000	Comp. Outputs	2	
	Bi 4-M12-VN6X-H1141	T1643200	Ext. Range, Comp. Outputs	4	
	Bi 2-M12-VP6X-H1141	T1633000	Comp. Outputs	2	4-Wire DC PNP
	Bi 4-M12-VP6X-H1141	T1633200	Ext. Range, Comp. Outputs	4	
	Bi 4-EM12-VP6X-H1141	T1633201	Ext. Range, Comp. Outputs	4	
	Bi 2-EM12-Y0X-H1141	T4010098		2	2-Wire DC NAMUR
	Bi 2-M12-Y1X-H1141	M4010200		2	

Voltage	Switching Freq. (Hz)	Operating Current (mA)	Operating Temp. (°C)	Protection	Housing	Face	Power LED	Output LED	Mating Cordset	Wiring Diagram #	Wiring Diagrams
10-30 VDC	2000	≤200	-25 to +70	IP 67	CPB	PA 12	N/A	YE	RK 4T-*	2	Diagram 1
10-30 VDC	2000	≤200	-25 to +70	IP 67	CPB	PA 12	N/A	YE	RK 4T-*	3	
10-30 VDC	2000	≤200	-25 to +70	IP 67	CPB	PA 12	N/A	YE	RK 4.4T-*	5	Diagram 2
10-30 VDC	2000	≤200	-25 to +70	IP 67	CPB	PA 12	N/A	YE	RK 4.4T-*	5	
10-65 VDC	1000	≤100	-25 to +70	IP 67	CPB	PA 12	N/A	YE	RK 4.2T-*	1	Diagram 3
10-65 VDC	1000	≤100	-25 to +70	IP 67	CPB	PA 12	N/A	YE	RK 4.2T-*	1	
10-30 VDC	2000	≤200	-25 to +70	IP 67	SS	PA 12	N/A	YE	RKV 4T-*	2	
	2000	≤200	-25 to +70	IP 67	CPB	PA 12	N/A	YE	RK 4T-*	2	
	2000	≤200	-25 to +85	IP 68, 69K	SS	PVDF	N/A	YE	RK 4T-*	2	
	3000	≤200	-25 to +85	IP 68, 69K	SS	PVDF	N/A	YE	RK 4T-*	2	
	3000	≤200	-30 to +85	IP 68	SS	PA 12	N/A	YE	RKV 4T-*	2	
	3000	≤200	-30 to +85	IP 67	CPB	PA 12	N/A	YE	RK 4T-*	2	
	3000	≤200	-30 to +85	IP 67	CPB	PA 12	GN	YE	RK 4T-*	2	
2000	≤200	-25 to +70	IP 67	CPB	PA 12	N/A	YE	RK 4T-*	2		
10-30 VDC	2000	≤200	-25 to +70	IP 67	SS	PA 12	N/A	YE	RKV 4T-*	3	
	2000	≤200	-25 to +70	IP 67	CPB	PA 12	N/A	YE	RK 4T-*	3	
	2000	≤200	-25 to +85	IP 68, 69K	SS	PVDF	N/A	YE	RK 4T-*	3	
	3000	≤200	-25 to +85	IP 68, 69K	SS	PVDF	N/A	YE	RK 4T-*	3	
	3000	≤200	-30 to +85	IP 68	SS	PA 12	N/A	YE	RKV 4T-*	3	
	3000	≤200	-30 to +85	IP 68	SS	SF	N/A	YE	RKG 4T-*/S600	3	
	3000	≤200	-30 to +85	IP 67	CPB	PA 12	N/A	YE	RK 4T-*	3	
	3000	≤200	-30 to +85	IP 67	CPB	PA 12	N/A	YE	RK 4T-*	3	
2000	≤200	-25 to +70	IP 67	CPB	PA 12	N/A	YE	RK 4T-*	3		
10-30 VDC	2000	≤200	-25 to +70	IP 67	CPB	PA 12	N/A	YE	RK 4.4T-*	4	
	2000	≤200	-25 to +70	IP 67	CPB	PA 12	N/A	YE	RK 4.4T-*	4	
10-30 VDC	2000	≤200	-25 to +70	IP 67	CPB	PA 12	N/A	YE	RK 4.4T-*	5	
	2000	≤200	-25 to +70	IP 67	CPB	PA 12	N/A	YE	RK 4.4T-*	5	
	2000	≤200	-25 to +70	IP 67	SS	PA 12	N/A	YE	RKV 4.4T-*	5	
5-30 VDC	5000	Remote	-25 to +70	IP 67	SS	PA 12	N/A	YE	RKV 4.21T-*	6	
	5000	Remote	-25 to +70	IP 67	CPB	PA 12	N/A	YE	RK 4.21T-*	6	

* Length in meters.

WIRING DIAGRAM

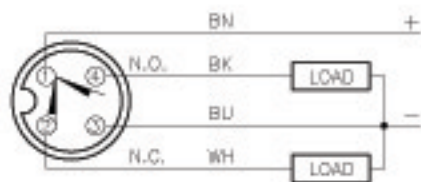

OUTPUT: VP6X

LOCKNUT LN-M12

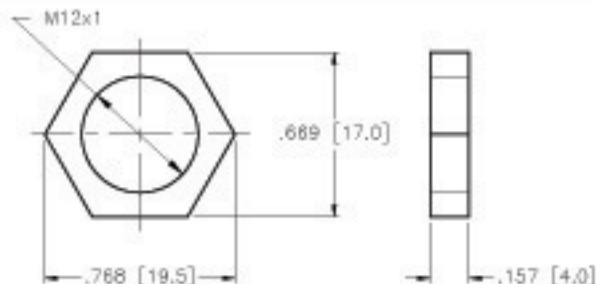

SPECIFICATIONS

OPERATING VOLTAGE	10-30 V DC (SHORT-CIRCUIT PROTECTED)
RIPPLE	≤ 10%
HYSTERESIS (DIFFERENTIAL TRAVEL)	3-15% (5% TYPICAL)
VOLTAGE DROP ACROSS CONDUCTING SENSOR	≤ 1.8 V at 200 mA
OUTPUT FUNCTION	COMPLEMENTARY OUTPUT ONE N.O., ONE N.C. (SPST)
TTL COMPATIBLE	NO
SHORT-CIRCUIT PROTECTED	YES
TRIGGER CURRENT FOR OVERLOAD PROTECTION	≥ 220 mA
CONTINUOUS LOAD CURRENT	≤ 200 mA
OFF-STATE (LEAKAGE) CURRENT	< 10 μ A
NO-LOAD CURRENT	5.5-9.5 mA
TIME DELAY BEFORE AVAILABILITY	≤ 8 ms
POWER-ON EFFECT	Per IEC 947-5-2
REVERSE POLARITY PROTECTION	INCORPORATED
WIRE-BREAK PROTECTION	INCORPORATED
TRANSIENT PROTECTION	Per EN 60947-5-2
OPERATING TEMPERATURE	-25°C to +70°C (-13°F to +158°F)
ENCLOSURE	MEETS NEMA 1, 3, 4, 6, 13 AND IEC IP67
SHOCK	30 g, 11 ms
VIBRATION	95 Hz, 1 mm AMPLITUDE (IN ALL 3 PLANES)
LED FUNCTION	YELLOW: OUTPUT ENERGIZED
RATED OPERATING DISTANCE(S _{RI})	2mm = 0.079" (NOMINAL)
SWITCHING FREQUENCY	2000 Hz
REPEATABILITY	≤ 2% of RATED OPERATING DISTANCE
SHIELDED	YES

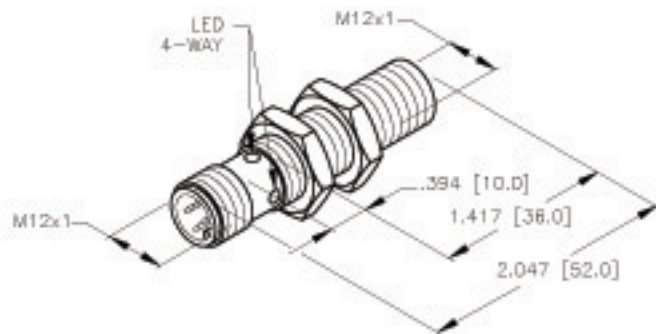

SOURCE DRAWING - FOR REFERENCE ONLY

NOTE: ALL TOLERANCES ±1.0 mm.

RELATED DOCUMENTS 1. 2. 3. 4.	3RD ANGLE PROJECTION 	THIS DRAWING IS PROPERTY OF TURCK INC. USE OF THIS DOCUMENT WITHOUT WRITTEN PERMISSION IS PROHIBITED.		 High Technology Sensors and Automation Controls	
	MATERIAL	TOLERANCES UNLESS OTHERWISE SPECIFIED	DRAWN IK		
FINISH	+0.0394 in [±1.00 mm]	UNIT OF MEASUREMENT INCH [MILLIMETER]	SCALE 1 = 1.5	IDENTIFICATION NO. T1633000	REV B
DO NOT SCALE THIS DRAWING			FILE: T1633000	SHEET 1 OF 1	

BY	IK	03/09/00	T3437
REV	DESCRIPTION	BY	DATE