

# Inductive Sensors

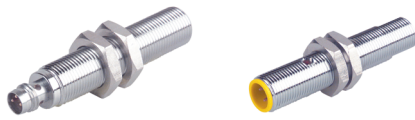
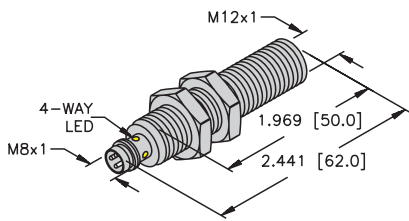
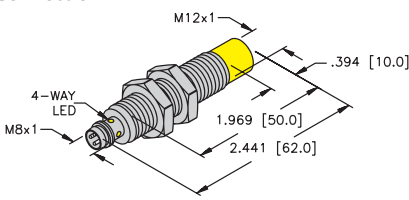
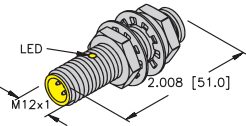
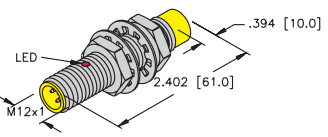
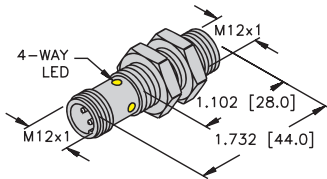
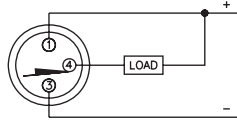
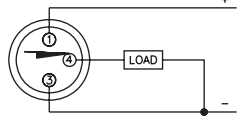
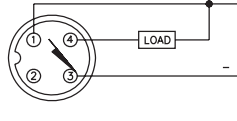
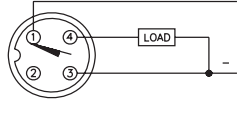
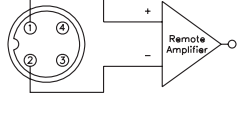
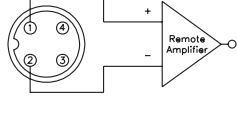
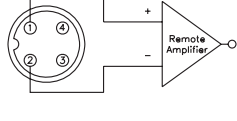
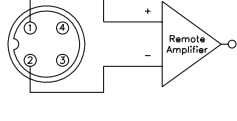

Housing Style	Part Number	ID Number	Features	Sensing Range (mm)	Output
<b>12 mm - Embeddable, picofast® Connection</b> 	Bi 2-G12-AN6X-V1131	T4635583		2	3-Wire DC NPN
	Bi 4-G12-AN6X-V1131	M1690707	Extended Range	4	
	Bi 2-G12-AP6X-V1131	T4606597		2	3-Wire DC PNP
	Bi 4-G12-AP6X-V1131	M1690703	Extended Range	4	
<b>12 mm - Nonembeddable, picofast Connection</b> 	Ni 5-G12-AN6X-V1131	T4635721		5	3-Wire DC NPN
	Ni 5-G12-AP6X-V1131	T4635690		5	3-Wire DC PNP
<b>12 mm - Embeddable, eurofast® Connection</b> 	Bi 2-G12-AN6X-H1141	T4606693		2	3-Wire DC NPN
	Bi 2-G12-AP6X-H1141	T4606595		2	3-Wire DC PNP
	Bi 4-EG12-AP6X-H1141	T4607091	Extended Range	4	
<b>12 mm - Nonembeddable, eurofast Connection</b> 	Ni 5-G12-AN6X-H1141	T4635793		5	3-Wire DC NPN
	Ni 5-G12-AN7X-H1141	T1714593		5	
	Ni 8-G12-AN6X-H1141	T4611383	Extended Range	8	
	Ni 5-G12-AP6X-H1141	T4635692		5	3-Wire DC PNP
	Ni 5-G12-Y0-H1141	T1005594		5	2-Wire DC NAMUR
<b>12 mm - Embeddable, eurofast Connection</b> 	Bi 2-G12K-AP6X-H1141	M4670260		2	3-Wire DC PNP

Voltage	Switching Freq. (Hz)	Operating Current (mA)	Operating Temp. (°C)	Protection	Housing	Face	Power LED	Output LED	Mating Cordset	Wiring Diagram #	Wiring Diagrams
10-30 VDC	2000	≤200	-25 to +70	IP 67	CPB	PA 12	N/A	YE	PKG 3Z-*	1	<b>Diagram 1</b> 
	2000	≤200	-25 to +70	IP 67	CPB	PA 12	N/A	YE	PKG 3Z-*	1	
10-30 VDC	2000	≤200	-25 to +70	IP 67	CPB	PA 12	N/A	YE	PKG 3Z-*	2	<b>Diagram 2</b> 
	2000	≤200	-25 to +70	IP 67	CPB	PA 12	N/A	YE	PKG 3Z-*	2	
10-30 VDC	2000	≤200	-25 to +70	IP 67	CPB	PA 12	N/A	YE	PKG 3Z-*	1	<b>Diagram 3</b> 
10-30 VDC	2000	≤200	-25 to +70	IP 67	CPB	PA 12	N/A	YE	PKG 3Z-*	2	<b>Diagram 4</b> 
10-30 VDC	2000	≤200	-25 to +70	IP 67	CPB	PA 12	N/A	YE	RK 4T-*	3	<b>Diagram 5</b> 
10-30 VDC	2000	≤200	-25 to +70	IP 67	SS	PA 12	N/A	YE	RKV 4T-*	4	
10-30 VDC	2000	≤200	-25 to +70	IP 67	CPB	PA 12	N/A	YE	RK 4T-*	3	<b>Diagram 5</b> 
	2000	≤200	-25 to +70	IP 67	CPB	PA 12	N/A	YE	RK 4T-*	3	
	2000	≤200	-25 to +70	IP 67	CPB	PA 12	N/A	YE	RK 4T-*	3	
10-30 VDC	2000	≤200	-25 to +70	IP 67	CPB	PA 12	N/A	YE	RK 4T-*	4	<b>Diagram 5</b> 
5-30 VDC	2000	Remote	-25 to +70	IP 67	CPB	PA 12	N/A	N/A	RK 4.21T-*	5	
10-30 VDC	2000	≤200	-25 to +70	IP 67	CPB	PA 12	N/A	N/A	RK 4T-*	4	<b>Diagram 5</b> 
10-30 VDC	2000	≤200	-25 to +70	IP 67	CPB	PA 12	N/A	N/A	RK 4T-*	4	

\* Length in meters.

WIRING DIAGRAMS



OUTPUT: AN6X

SHORT-CIRCUIT AND OVERLOAD PROTECTED

LOCKNUT LN-M12

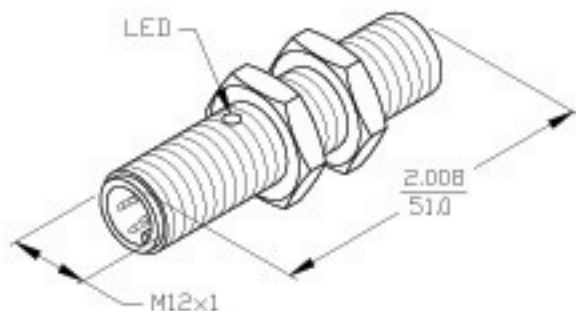
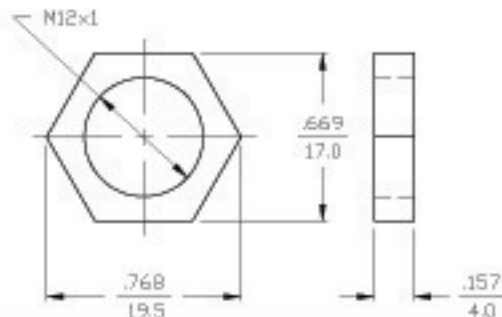

SPECIFICATIONS

OPERATING VOLTAGE	10-30 V DC (SHORT-CIRCUIT PROTECTED)
RIPPLE	≤10%
HYSTERESIS (DIFFERENTIAL TRAVEL)	3-15% (5% TYPICAL)
VOLTAGE DROP ACROSS CONDUCTING SENSOR	≤1.8 V at 200 mA
OUTPUT FUNCTION	NORMALLY OPEN 3-WIRE DC SELF-CONTAINED
TTL COMPATIBLE	NO
SHORT-CIRCUIT PROTECTED	YES
TRIGGER CURRENT FOR OVERLOAD PROTECTION	≥220 mA
CONTINUOUS LOAD CURRENT	≤200 mA
LEAKAGE (OFF-STATE) CURRENT	<10 μA
NO-LOAD CURRENT	5.5-9.5 mA
TIME DELAY BEFORE AVAILABILITY	≤8 ms
POWER-ON EFFECT PROTECTION	INCORPORATED
POLARITY INVERSION PROTECTION	INCORPORATED
WIRE BREAK PROTECTION	INCORPORATED
PROTECTION AGAINST TRANSIENTS	2 kV, 1 ns, 1 kΩ
OPERATING TEMPERATURE	-25°C to +70°C (-13°F to +158°F)
ENCLOSURE	MEETS NEMA 1, 3, 4, 6, 13 AND IEC IP67
SHOCK	30 g, 11 ms
VIBRATION	55 Hz, 1 mm AMPLITUDE (ON ALL 3 PLANES)
LED FUNCTION	RED OUTPUT ENERGIZED
SENSING RANGE	2 mm = .079" (NOMINAL)
SWITCHING FREQUENCY	2000 Hz
REPEATABILITY	≤2%
SHIELDED	YES

MATERIAL <b>BRASS BARREL</b>		3RD ANGLE PROJECTION 		<b>TUBON INC</b>	
FINISH <b>COPPER/NICKEL/ CHROME PLATING</b>					
DRWN <b>GMB</b>	DATE <b>4/4/89</b>	PART NO. <b>Bi2-G12-AN6X-H1141</b>			
D-KD	DATE				
THI	DATE	SIZE <b>B</b>	ID NO. <b>4606693</b>	REV <b>A</b>	
DIMENSIONS ARE IN <b>INCHES</b> mm		SCALE <b>NONE</b>	<b>BMQD\4606693</b>	SHEET <b>1</b> OF <b>1</b>	

A	SEE REVISION DOCUMENT G12H-AN6	GMB	3/22/91		
REV	DESCRIPTION	DRFT	DATE	CHKD	
REVISIONS					