

Inductive Sensors

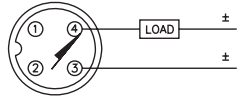
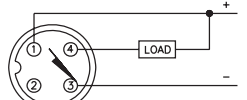
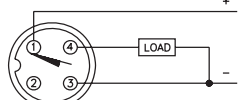
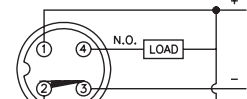
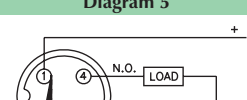
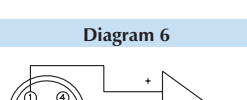

Housing Style	Part Number	ID Number	Features	Sensing Range (mm)	Output
30 mm - Embeddable, eurofast® Connection 	Bi 10-M30-AD4X-H1141	T4417500		10	2-Wire DC
	Bi 12-M30-AD4X-H1141	T4417041	Extended Range	12	
	Bi 10-M30-AN6X-H1141	T4617600		10	3-Wire DC NPN
	Bi 10U-EM30-AN6X-H1141	M1636350	Uprox	10	
	Bi 10U-EM30H-AN6X2-H1141	M1636407	Uprox, Stoneface	10	
	Bi 10U-EM30H-AN6X2-H1141/S1589	M1636490	weldguard, Uprox	10	
	Bi 10U-M30-AN6X-H1141	M1636150	Uprox	10	
	Bi 10U-M30-AN6X2-H1141	M1636155	Uprox	10	
	Bi 12-EM30WD-AN6X-H1141	M4614544	Washdown	12	
	Bi 15-M30-AN6X-H1141	T4618600	Extended Range	15	
	Bi 15-EM30H-AN6X-H1141	T4618692	Extended Range	15	
	Bi 15-EM30H-AN6X-H1141/S1589	T4618693	weldguard	15	
	Bi 10-M30-AP6X-H1141	T4617500		10	3-Wire DC PNP
	Bi 10U-EM30-AP6X-H1141	M1636340	Uprox	10	
	Bi 10U-EM30H-AP6X2-H1141	M1636406	Uprox, Stoneface	10	
	Bi 10U-EM30H-AP6X2-H1141/S1589	M1636491	weldguard, Uprox	10	
	Bi 10U-M30-AP6X-H1141	M1636140	Uprox	10	
	Bi 10U-M30-AP6X2-H1141	M1636145	Uprox	10	
	Bi 12-EM30WD-AP6X-H1141	M4614541	Washdown	12	
	Bi 15-M30-AP6X-H1141	T4618500	Extended Range	15	
	Bi 15-EM30H-AP6X-H1141	T4618592	Extended Range	15	
	Bi 15-EM30H-AP6X-H1141/S1589	T4618593	weldguard	15	
	Bi 15-EM30H-AP6X-H1141/S1610	T4618589	Weld/armorguard	15	
	Bi 10-M30-VN4X-H1141	T1571600	Comp. Outputs	10	4-Wire DC NPN
	Bi 10U-M30-VN4X-H1141	M1582352	Uprox, Comp. Outputs	10	
	Bi 15-M30-VN4X-H1141	T4570711	Comp. Outputs	15	4-Wire DC PNP
	Bi 10-M30-VP4X-H1141	T1561600	Comp. Outputs	10	
	Bi 10U-M30-VP4X-H1141	M1582253	Uprox, Comp. Outputs	10	
	Bi 15-M30-VP4X-H1141	T4570710	Comp. Outputs	15	2-Wire DC
	Bi 10-M30-Y1X-H1141	M4020200		10	
30 mm - Embeddable, eurofast Connection, Stainless Steel 	Bi 10-EM30F-AP6X-H1141	M4614537	Stainless Steel Front Cap	10	3-Wire DC PNP

Voltage	Switching Freq. (Hz)	Operating Current (mA)	Operating Temp. (°C)	Protection	Housing	Face	Power LED	Output LED	Mating Cordset	Wiring Diagram #	Wiring Diagrams					
10-65 VDC	500	≤100	-25 to +70	IP 67	CPB	PA 12	N/A	YE	RK 4.2T-*	1	Diagram 1 					
	500	≤100	-25 to +70	IP 67	CPB	PA 12	N/A	YE	RK 4.2T-*	1						
10-30 VDC	500	≤200	-25 to +70	IP 67	CPB	PA 12	N/A	YE	RK 4T-*	2	Diagram 2 					
	2000	≤200	-30 to +85	IP 68	SS	PA 12	N/A	YE	RKV 4T-*	2						
	2000	≤200	-30 to +85	IP 68	SS	SF	GN	YE	RKV 4T-*	2						
	2000	≤200	-30 to +85	IP 68	SS	WG	GN	YE	RKG 4T-*/S600	2						
	2000	≤200	-30 to +85	IP 67	CPB	PA 12	N/A	YE	RK 4T-*	2						
	2000	≤200	-30 to +85	IP 67	CPB	PA 12	GN	YE	RK 4T-*	2						
	1000	≤200	-25 to +85	IP 68, 69K	SS	PVDF	N/A	YE	RK 4T-*	2						
	300	≤200	-25 to +70	IP 67	CPB	PA 12	N/A	YE	RK 4T-*	2						
	300	≤200	-25 to +70	IP 67	SS	SF	N/A	YE	RKG 4T-*/S600	2						
	300	≤200	-25 to +70	IP 67	SS	WG	N/A	YE	RKG 4T-*/S600	2						
10-30 VDC	500	≤200	-25 to +70	IP 67	CPB	PA 12	N/A	YE	RK 4T-*	3	Diagram 3 					
	2000	≤200	-30 to +85	IP 68	SS	PA 12	N/A	YE	RKV 4T-*	3						
	2000	≤200	-30 to +85	IP 68	SS	SF	GN	YE	RKV 4T-*	3						
	2000	≤200	-30 to +85	IP 68	SS	WG	GN	YE	RKG 4T-*/S600	3						
	2000	≤200	-30 to +85	IP 67	CPB	PA 12	N/A	YE	RK 4T-*	3						
	2000	≤200	-30 to +85	IP 67	CPB	PA 12	GN	YE	RK 4T-*	3						
	1000	≤200	-25 to +85	IP 68, 69K	SS	PVDF	N/A	YE	RK 4T-*	3						
	300	≤200	-25 to +70	IP 67	CPB	PA 12	N/A	YE	RK 4T-*	3						
	300	≤200	-25 to +70	IP 67	SS	SF	N/A	YE	RKV 4T-*	3						
	300	≤200	-25 to +70	IP 67	SS	WG	N/A	YE	RKG 4T-*/S600	3						
10-65 VDC	500	≤200	-25 to +70	IP 67	CPB	PA 12	N/A	YE	RK 4.4T-*	4	Diagram 4 					
	2000	≤200	-30 to +85	IP 67	CPB	PA 12	N/A	YE	RK 4.4T-*	4						
	500	≤200	-25 to +70	IP 67	CPB	PA 12	N/A	YE	RK 4.4T-*	4						
	10-65 VDC	500	≤200	-25 to +70	IP 67	CPB	PA 12	N/A	YE	RK 4.4T-*		5	Diagram 5 			
		2000	≤200	-30 to +85	IP 67	CPB	PA 12	N/A	YE	RK 4.4T-*		5				
		300	≤200	-25 to +70	IP 67	CPB	PA 12	N/A	YE	RK 4.4T-*		5				
		5-30 VDC	2000	Remote	-25 to +70	IP 67	CPB	PA 12	N/A	YE		RK 4.21T-*		6	Diagram 6 	
			10-30 VDC	180	≤200	-25 to +80	IP 68, 69K	SS	SS	N/A		YE		RKV 4T-*		3

* Length in meters.

WIRING DIAGRAM



LOCKNUT LN-M30

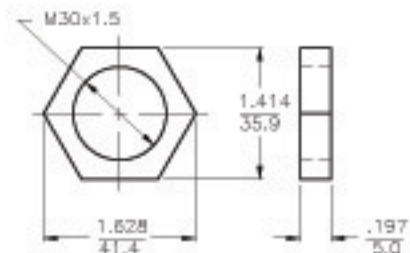

SHORT-CIRCUIT AND OVERLOAD PROTECTED

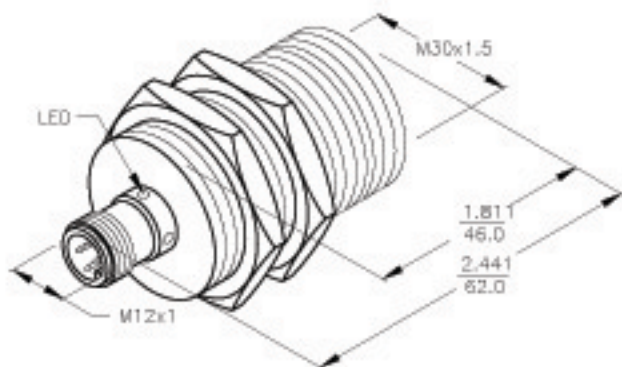

SPECIFICATIONS

OPERATING VOLTAGE	10-30 VDC
RIPPLE	≤ 10%
DIFFERENTIAL TRAVEL (HYSTERESIS)	3-15% (5% TYPICAL)
VOLTAGE DROP ACROSS CONDUCTING SENSOR	≤ 1.5 V at 200 mA
OUTPUT FUNCTION	NORMALLY OPEN 3-WIRE DC SELF-CONTAINED
TTL COMPATIBLE	NO
SHORT-CIRCUIT PROTECTED	YES
TRIGGER CURRENT FOR OVERLOAD PROTECTION	≥ 220 mA
CONTINUOUS LOAD CURRENT	≤ 200 mA
OFF-STATE (LEAKAGE) CURRENT	≤ 0.1 mA
NO-LOAD CURRENT	≤ 8 mA
TIME DELAY BEFORE AVAILABILITY	≤ 8 ms
POWER-ON EFFECT	PER IEC 947-5-2
REVERSE POLARITY PROTECTION	INCORPORATED
WIRE-BREAK PROTECTION	INCORPORATED
PROTECTION AGAINST TRANSIENTS	Per EN 60947-5-2
OPERATING TEMPERATURE (10% DRIFT)	-25°C to +70°C (-13°F to +158°F)
OPERATING TEMPERATURE (15% DRIFT)	-30°C to +85°C (-22°F to +185°F)
ENCLOSURE	MEETS NEMA 1, 3, 4, 6, 13 AND IEC IP67
SHOCK	30 g, 11 ms
VIBRATION	55 Hz, 1 mm AMPLITUDE (IN ALL 3 PLANES)
LED FUNCTION	YELLOW: OUTPUT ENERGIZED
RATED OPERATING DISTANCE(Sn)	15 mm = .591" (NOMINAL)
SWITCHING FREQUENCY	300 Hz
REPEATABILITY	≤ 2% of RATED OPERATING DISTANCE
EMBEDDABLE (SHIELDED)	YES
MATING PLUGS/CABLES	4-PIN "EUROFAST" CONSTRUCTION

RELATED DOCUMENTS 1. 2. 3. 4.	3RD ANGLE PROJECTION 	THIS DRAWING IS PROPERTY OF TURCK INC. USE OF THIS DOCUMENT WITHOUT WRITTEN PERMISSION IS PROHIBITED.		TURCK INC High Technology Sensors and Automation Controls	
	MATERIAL BRASS BARREL	TOLERANCES UNLESS OTHERWISE SPECIFIED 0.0394in [1.00mm]	DRFT CBM	DATE 09/26/99	DESCRIPTION Bi15-M30-AN6X-H1141
FINISH COPPER, NICKEL, CHROME PLATING		UNIT OF MEASUREMENT INCH [MILLIMETER]	SCALE NONE	IDENTIFICATION NO. T4618600	REV A
A DRAWING RELEASE	CBM 09/28/99	DO NOT SCALE THIS DRAWING		FILE: T4618600	SHEET 1 OF 1

REV	DESCRIPTION	BY	DATE	EDD NO.
-----	-------------	----	------	---------