

Beacons and Indicator Banks XVE 70mm Optimum

Catalog
2004

Class 9001



CONTENTS

Description	Page
PRESENTATION	3
DESCRIPTION	4
CHARACTERISTICS	5
SELECTION	6
DIMENSIONS, MOUNTING, CONNECTIONS	9
INDEXED CATALOG NUMBERS	11

PRESENTATION

The beacons and indicator banks of the XVE range are designed for remote signalling of the status of a machine, equipment or specific application, either visually using illuminated units which are visible throughout 360° or audibly using an 85 dB buzzer. The XVE Optimum range provides efficient signalling (5 colors available), at medium range distances 98.4 ft (30 m), in indoor environments.

The standard configuration of the beacons and indicator banks is NEMA and UL Type 12 (IP 42) degree of protection, which is sufficient for the majority of indoor applications. Both pre-configured beacons and indicator banks can be upgraded to IP 54 by using a sealing kit.

Composition

- The beacons are supplied complete and incorporate a single steady or strobe light illuminated unit and a short mounting base. They are ready to use.
- The indicator banks must be assembled by the user and comprise signalling units, mounted on a base unit, and a mounting base. These various items are to be selected from the catalog.
- For an indicator bank, a maximum of 5 illuminated units or 4 illuminated units + 1 audible unit can be assembled.
- The illuminated or audible units stack vertically and are easily assembled. A screw secures their mounting. Electrical connections between each unit are made automatically as the units are mechanically assembled.
- All the signalling units are identical in size and their positioning is unrestricted.

SIGNALLING FUNCTIONS

Steady Light Signalling

Two types of light source are available for steady light signalling:

- The incandescent BA 15d base fitting bulb, 5 W max. power, is recommended for infrequent usage and where no vibration or mechanical shock exists. The bulb is not included with the lens unit and must be installed separately.
- LEDs are recommended for continuous usage: 100,000 operating hours without maintenance and low consumption. They have good resistance to vibration. Using an LED of a color best suited to the color of the lens unit provides optimal luminosity.

Flashing Light Signalling

Flashing light signalling is also obtained using the LED. It meets requirements regarding reliability, continuous usage and electronic simplicity.

A flashing function can also be obtained from a steady light LED or incandescent illuminated unit by using a PLC output signal.

Strobe Light Signalling

The light source is a 1 Joule discharge tube which delivers a powerful warning signal. It is available for all 5 colors.

Audible Signalling

Audible signalling is provided by a continuous tone buzzer with a power rating of 85 dB at 3.28 ft. (1 m).

INSTALLATION

Mounting

Mounted onto support panel using a plastic mounting base or mounting base comprising an aluminium support tube pre-fitted into a plastic mounting support.

Cabling

Cabling by means of terminal block incorporated in base unit. The terminals are protected and of the screw and captive cable clamp type.

70 mm Optimum, Type XVE

DESCRIPTION

Illuminated Beacon

The illuminated beacon is a complete product comprising:

1. A screw mounting cover
2. One colored illuminated unit (green, red, orange, blue or clear).
3. A base unit with terminal block and bottom cable entry.
4. A plastic mounting base for mounting on machine.

Indicator Bank

The indicator bank is a customer assembled product using:

5. A snap on cover
6. 1 to 5 colored illuminated units (green, red, orange, blue or clear) with a choice of 3 types of signalling (steady, flashing or "strobe").
7. 1 audible unit.
8. A base unit with terminal block and bottom cable entry.
9. A plastic mounting base, 0.78" (20 mm) high.
10. A plastic mounting base, 3.9" (100 mm) high.
11. An aluminium support tube, black or silver finish, length: 3.1" (80 mm), 15.7" (400 mm), or 31.5" (800 mm), pre-fitted and glued into a mounting base.

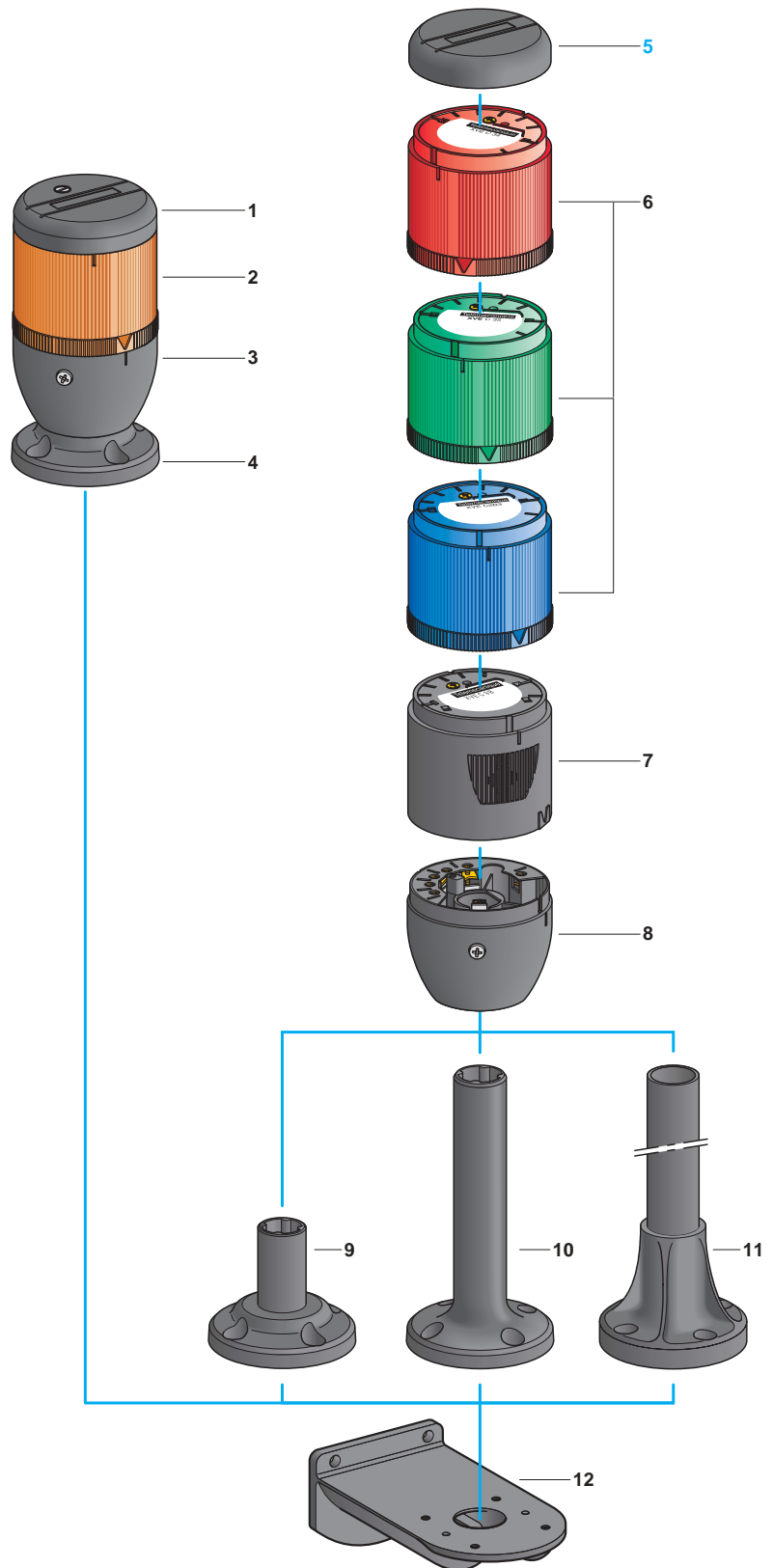

To be ordered separately:

12. Base plate for mounting on vertical support.



CHARACTERISTICS

Environment

Degree of protection	Conforming to IEC 60529, and UL508		<ul style="list-style-type: none"> NEMA and UL Type 12 (IP 42) in vertical position for all mounting positions using mounting base XVE Z13, only in vertical position for other heights of mounting base
Product certifications		 File E164353 CCN NKCR  File LR44087 Class 3211 03, and CCC	
Approvals			CE
Conformity to standards			IEC/EN 60947-1, IEC/EN 60947-5-1
Ambient air temperature	For storage	°F	- 104...+ 158 (- 40 °C...+ 70 °C)
	For operation	°F	- 75...+ 131 (- 25 °C...+ 55 °C)
Electric shock protection Conforming to IEC 61140	Mounted on plastic support tube		Class I
	Mounted on aluminium support tube		Class I
Protective treatment			Standard version: "TC"
Electronic components protection (LED and flash)	By integral fuse in series on the common	A	0.63 (\approx 24 Vac/dc)
		A	0.16 (\approx 120...240 Vac)

Electrical Characteristics

Illuminated units			With bulb, not included (lens unit only)	With integral LED, steady light	With integral LED, flashing light	With "strobe" discharge tube, 1 Joule
Rated insulation voltage (Ui)	Conforming to IEC 60947-1	V	250	250	250	250
Voltage limits	Conforming to IEC 60947-5-1	V	0.85...1.10 Un (Un: nominal voltage)			
Light source			BA 15d base fitting bulb, maximum power 5 W (240 V max.)	LED	LED	"strobe" discharge tube, 1 Joule
Consumption	On \approx 24 Vac/dc	mA	Depending on bulb used	< 25	< 30	< 145 on \approx 24 Vac < 85 on \approx 24 Vdc
	On \approx 120 Vac/dc	mA	Depending on bulb used	< 25	< 25	< 35
	On \approx 230/240 Vac	mA	Depending on bulb used	< 25	< 25	< 25
Rated impulse withstand voltage	Conforming to IEC 60947-1	kV	U imp = 4			
Illuminating power	Average value for all colors	cds/m ²	640	800	800	–
Flashing frequency	Nominal value	Hz	–	–	1	1
Audible units						
Consumption	On \approx 24 Vac/dc	mA	< 15			
	On \approx 120 Vac/dc	mA	< 25			
	On \approx 230/240 Vac	mA	< 25			
Power	Continuous tone	dB	85 at 3.28 ft. (1 m)			
	Fundamental frequency	kHz	2.6 for continuous tone			
Connection of illuminated and audible units						
Terminal referencing			1 terminal referenced "C" common to all 5 units 5 terminals referenced 1 to 5			
Connection	Maximum clamping capacity on protected, ready-to-tighten, screw and captive cable clamp terminals	AWG	1 x # 16			
		mm ²	1 x 1.5 with cable end			

Presentation:
pages 3 and 4Selection:
pages 6 to 8Dimensions:
9 and 10

70 mm Optimum, Type XVE Illuminated Beacons

SELECTION



XVE L3●●



XVE L2●●



XVE L6●●



XVE Z083



XVB C12



XVE Z13



DL1 BE●S

Illuminated Beacons with Steady Light

Description	Light source	Supply voltage	Color of lens unit	Catalog Number	Weight lb/kg
Complete unit comprising: 1 screw mounting cover, 1 illuminated unit, 1 base unit, 1 short mounting base	Bulb, not included, 5 W max.	≈ 240 Vac/dc max.	Green	XVEL33	0.54/0.245
			Red	XVEL34	0.54/0.245
			Orange	XVEL35	0.54/0.245
			Blue	XVEL36	0.54/0.245
			Clear	XVEL37	0.54/0.245
			Green	XVEL2B3	0.55/0.250
			Red	XVEL2B4	0.55/0.250
	Illuminated unit with integral LED	≈ 24 Vac/dc	Orange	XVEL2B5	0.55/0.250
			Blue	XVEL2B6	0.55/0.250
			Clear	XVEL2B7	0.55/0.250
			Green	XVEL2G3	0.55/0.250
			Red	XVEL2G4	0.55/0.250
			Orange	XVEL2G5	0.55/0.250
			Blue	XVEL2G6	0.55/0.250
Illuminated unit with integral LED	~ 120 Vac	Clear	XVEL2G7	0.55/0.250	
		Green	XVEL2M3	0.55/0.250	
		Red	XVEL2M4	0.55/0.250	
		Orange	XVEL2M5	0.55/0.250	
		Blue	XVEL2M6	0.55/0.250	
		~ 230 V/240 Vac	Clear	XVEL2M7	0.55/0.250

Illuminated Beacons with Strobe Light

Description	Light source	Supply voltage	Color of lens unit	Catalog Number	Weight lb/kg	
Complete unit comprising: 1 screw mounting cover, 1 illuminated unit, 1 base unit, 1 short mounting base	Illuminated unit with 1 Joule discharge tube	≈ 24 Vac/dc	Green	XVEL6B3	0.59/0.270	
			Red	XVEL6B4	0.59/0.270	
			Orange	XVEL6B5	0.59/0.270	
			Blue	XVEL6B6	0.59/0.270	
			Clear	XVEL6B7	0.59/0.270	
			Green	XVEL6G3	0.59/0.270	
			Red	XVEL6G4	0.59/0.270	
	Illuminated unit with 1 Joule discharge tube	~ 120 Vac	Orange	XVEL6G5	0.59/0.270	
			Blue	XVEL6G6	0.59/0.270	
			Clear	XVEL6G7	0.59/0.270	
			Green	XVEL6M3	0.59/0.270	
			Red	XVEL6M4	0.59/0.270	
			~ 230 V/240 Vac	Orange	XVEL6M5	0.59/0.270
				Blue	XVEL6M6	0.59/0.270
Clear	XVEL6M7	0.59/0.270				

Separate Components

Description	Details	Catalog Number	Weight lb/kg
IP 54 sealing kit	1 lens unit seal + 1 base unit seal + 2 mounting base seals	XVEZ083	0.01/0.005
Right angle mounting plate	For mounting beacons on vertical support (requires a mounting base)	XVBC12	0.84/0.380
Mounting base	For replacement 0.78" (20 mm)	XVEZ13	0.090/0.040
Description	Electrical characteristics	Catalog Number	Weight lb/kg
Clear incandescent bulbs with BA 15d base fitting for lens units type XVE L3●	5 W ≈ 24 Vac/dc	DL1BEBS	0.22/0.100
	5 WA ≈ 120 Vac/dc	DL1BEGS	0.22/0.100
	5 W ≈ 230 Vac/dc	DL1BEMS	0.22/0.100

70 mm Optimum, Type XVE Indicator Banks for Customer Assembly

Composition of an indicator bank:



1. Cover and base unit
+
2. Illuminated or audible units
(5 units max.)
+
3. Mounting base



Illuminated Units with Steady Light

Description	Light source	Supply voltage	Color of lens	Catalog Number	Weight lb/kg
Lens units only for BA 15d base fitting bulb	Bulb, not included, 5 W max.	≈ 240 Vac/dc max.	Green	XVEC33	0.16/0.072
			Red	XVEC34	0.16/0.072
			Orange	XVEC35	0.16/0.072
			Blue	XVEC36	0.16/0.072
			Clear	XVEC37	0.16/0.072
Illuminated units	Integral LED	≈ 24 Vac/dc	Green	XVEC2B3	0.17/0.077
			Red	XVEC2B4	0.17/0.077
			Orange	XVEC2B5	0.17/0.077
			Blue	XVEC2B6	0.17/0.077
			Clear	XVEC2B7	0.17/0.077
			Green	XVEC2G3	0.17/0.077
			Red	XVEC2G4	0.17/0.077
Illuminated units	Integral LED	~ 120 Vac	Orange	XVEC2G5	0.17/0.077
			Blue	XVEC2G6	0.17/0.077
			Clear	XVEC2G7	0.17/0.077
			Green	XVEC2M3	0.17/0.077
			Red	XVEC2M4	0.17/0.077
			Orange	XVEC2M5	0.17/0.077
			Blue	XVEC2M6	0.17/0.077
Illuminated units	Integral LED	~ 230 V/240 Vac	Clear	XVEC2M7	0.17/0.077

Illuminated Units with Flashing LED

Illuminated units	Integral LED	≈ 24 Vac/dc	Green	XVEC5B3	0.17/0.077
			Red	XVEC5B4	0.17/0.077
			Orange	XVEC5B5	0.17/0.077
			Blue	XVEC5B6	0.17/0.077
			Clear	XVEC5B7	0.17/0.077
Illuminated units	Integral LED	~ 120 Vac	Green	XVEC5G3	0.17/0.077
			Red	XVEC5G4	0.17/0.077
			Orange	XVEC5G5	0.17/0.077
			Blue	XVEC5G6	0.17/0.077
			Clear	XVEC5G7	0.17/0.077
			Green	XVEC5M3	0.17/0.077
			Red	XVEC5M4	0.17/0.077
Illuminated units	Integral LED	~ 230 V/240 Vac	Orange	XVEC5M5	0.17/0.077
			Blue	XVEC5M6	0.17/0.077
			Clear	XVEC5M7	0.17/0.077

Illuminated Units with Strobe Light

Illuminated units	Discharge tube, 1 Joule	≈ 24 Vac/dc	Green	XVEC6B3	0.21/0.094
			Red	XVEC6B4	0.21/0.094
			Orange	XVEC6B5	0.21/0.094
			Blue	XVEC6B6	0.21/0.094
			Clear	XVEC6B7	0.21/0.094
Illuminated units	Discharge tube, 1 Joule	~ 120 Vac	Green	XVEC6G3	0.21/0.094
			Red	XVEC6G4	0.21/0.094
			Orange	XVEC6G5	0.21/0.094
			Blue	XVEC6G6	0.21/0.094
			Clear	XVEC6G7	0.21/0.094
			Green	XVEC6M3	0.21/0.094
			Red	XVEC6M4	0.21/0.094
Illuminated units	Discharge tube, 1 Joule	~ 230 V/240 Vac	Orange	XVEC6M5	0.21/0.094
			Blue	XVEC6M6	0.21/0.094
			Clear	XVEC6M7	0.21/0.094

Audible Units

Description	Power	Supply voltage	Catalog Number	Weight lb/kg
Buzzer single tone	85 dB at 3.28 ft. (1 m)	≈ 24 Vac/dc	XVEC9B	0.20/0.090
		~ 120 Vac	XVEC9G	0.20/0.090
		~ 230 V/240 Vac	XVEC9M	0.20/0.090

Presentation:
pages 3 and 4

Characteristics:
page 5

Dimensions:
page 10

70 mm Optimum, Type XVE Indicator Banks for Customer Assembly



XVE C21



XVE C21P



XVE Z13 XVD C02



XVB Z02 XVB Z03



XVB C12



XVE Z081



XVE Z082



DL1 BE•S

Base Units and Covers

Indicator bank usage	Composition	Catalog Number	Weight lb/kg
NEMA and UL Type 12 (IP 42)	Base unit and cover	XVEC21	0.24/0.110
Additional protection (IP 54)	Base unit with seal + screw mounting cover + kit comprising 5 seals for lens units and buzzer + 1 seal for mounting base XVE Z13	XVEC21P	0.26/0.120

Mounting Components

Description	Height under base unit: inches (mm)	Color	Catalog Number	Weight lb/kg
Plastic mounting bases	0.78" (20)	Black	XVEZ13	0.09/0.040
	3.93" (100)	Black	XVDC02	0.12/0.056
Mounting bases comprising: Ø 25 mm aluminium support tube + black plastic mounting support	3.15" (80)	Black aluminium	XVBZ02	0.24/0.110
		Aluminium	XVBZ02A	0.24/0.110
	15.7" (400)	Black aluminium	XVBZ03	0.44/0.200
		Aluminium	XVBZ03A	0.44/0.200
	31.5" (800)	Black aluminium	XVBZ04	0.72/0.325
		Aluminium	XVBZ04A	0.72/0.325

Description	For	Material	Catalog Number	Weight lb/kg
Right angle mounting plate	Mounting indicator banks on vertical support (requires a mounting base)	Zamak	XVBC12	0.84/0.380

Separate components

Description	Composition	Catalog Number	Weight lb/kg
Cover	–	XVEZ081	0.02/0.010
IP 54 sealing kit	5 gaskets for lens units + base unit gasket + 1 mounting base gasket + 1 gasket for mounting base XVE Z13 + screw mounting cover	XVEZ082	0.030.015
Description	Electrical characteristics	Catalog Number	Weight lb/kg
Clear incandescent bulbs with BA 15d base fitting for lens units type XVE C3●	5 W ≈ 24 Vac/dc	DL1BEBS	0.22/0.100
	5 W ≈ 120 Vac/dc	DL1BEGS	0.22/0.100
	5 W ≈ 230 Vac/dc	DL1BEMS	0.22/0.100

70 mm Optimum, Type XVE Illuminated Beacons

DIMENSIONS, MOUNTING, WIRING

Illuminated Beacons XVE L●●●

Panel cut-out for mounting directly to base plate

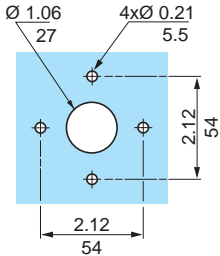
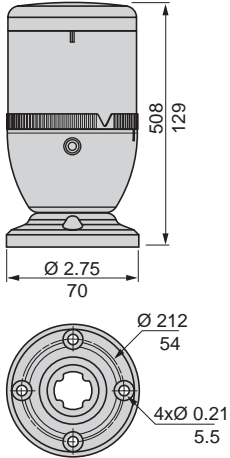

Mounting to base plate XVB C12

Vertical support panel drilling for mounting to base plate XVB C12

Wiring

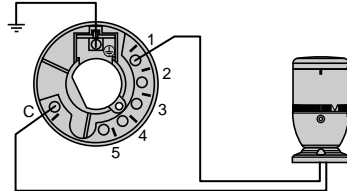
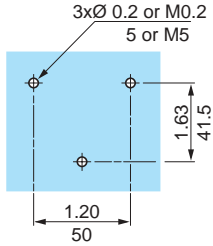
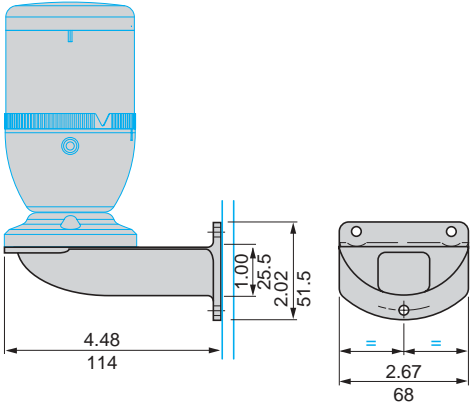

Dual Dimensions $\frac{\text{inches}}{\text{mm}}$

70 mm Optimum, Type XVE Indicator Banks

Indicator Banks XVE C●●●

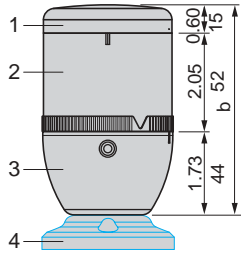

1. Cover XVE Z081 or cover XVE C21/C21P (with base unit),
2. Illuminated units XVE C●● and/or audible unit XVE C9●,
3. Base unit XVE C21/C21P,
4. Mounting bases (see below).

Height of indicator bank

Number of units (ref. 2)	b
1 unit	4.37/111
2 units	6.41/163
3 units	8.46/215
4 units	10.5/267
5 units	12.5/319

inches/mm

Mounting bases (height under base unit)

XVE Z13

XVD C02

XVB Z0●●

Panel cut-out for mounting directly to base plate

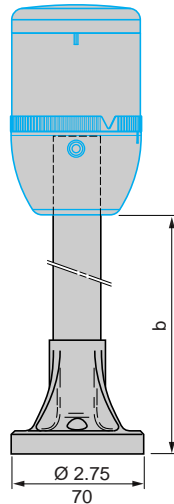
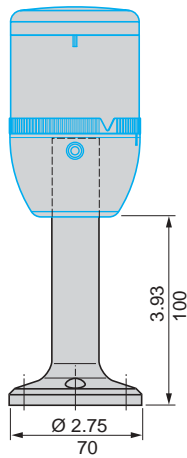
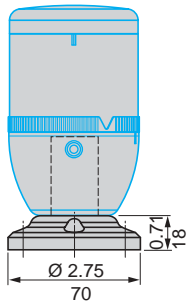

Dual Dimensions $\frac{\text{inches}}{\text{mm}}$

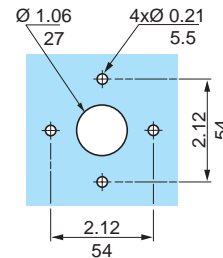

Height under base unit

Mounting base	b	inch/mm
XVB Z02/Z02A		3.15/80
XVB Z03/Z03A		15.74/400
XVB Z04/Z04A		31.50/800

Mounting on base plate XVB C12

Vertical support panel drilling for mounting base plate XVB C12

Wiring

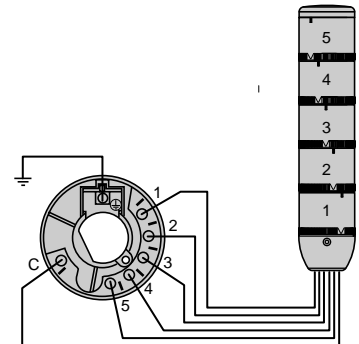
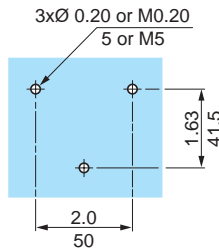
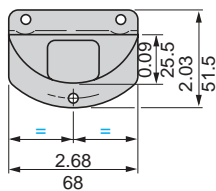
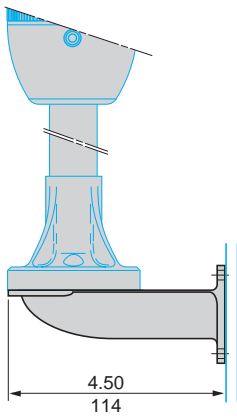

70 mm Optimum, Type XVE Indexed Catalog Numbers

Catalog Number	Page	Catalog Number	Page	Catalog Number	Page
DL1BEBS	6	XVEC5G5	7	XVEL36	6
DL1BEBS	8	XVEC5G6	7	XVEL37	6
DL1BEGS	6	XVEC5G7	7	XVEL6B3	6
DL1BEGS	8	XVEC5M3	7	XVEL6B4	6
DL1BEMS	6	XVEC5M4	7	XVEL6B5	6
DL1BEMS	8	XVEC5M5	7	XVEL6B6	6
XVBC12	6	XVEC5M6	7	XVEL6B7	6
XVBC12	8	XVEC5M7	7	XVEL6G3	6
XVBZ02	8	XVEC6B3	7	XVEL6G4	6
XVBZ02A	8	XVEC6B4	7	XVEL6G5	6
XVBZ03	8	XVEC6B5	7	XVEL6G6	6
XVBZ03A	8	XVEC6B6	7	XVEL6G7	6
XVBZ04	8	XVEC6B7	7	XVEL6M3	6
XVBZ04A	8	XVEC6G3	7	XVEL6M4	6
XVDC02	8	XVEC6G4	7	XVEL6M5	6
XVEC21	8	XVEC6G5	7	XVEL6M6	6
XVEC21P	8	XVEC6G6	7	XVEL6M7	6
XVEC2B3	7	XVEC6G7	7	XVEZ081	8
XVEC2B4	7	XVEC6M3	7	XVEZ082	8
XVEC2B5	7	XVEC6M4	7	XVEZ083	6
XVEC2B6	7	XVEC6M5	7	XVEZ13	6, 8
XVEC2B7	7	XVEC6M6	7		
XVEC2G3	7	XVEC6M7	7		
XVEC2G4	7	XVEC9B	7		
XVEC2G5	7	XVEC9G	7		
XVEC2G6	7	XVEC9M	7		
XVEC2G7	7	XVEL2B3	6		
XVEC2M3	7	XVEL2B4	6		
XVEC2M4	7	XVEL2B5	6		
XVEC2M5	7	XVEL2B6	6		
XVEC2M6	7	XVEL2B7	6		
XVEC2M7	7	XVEL2G3	6		
XVEC33	7	XVEL2G4	6		
XVEC34	7	XVEL2G5	6		
XVEC35	7	XVEL2G6	6		
XVEC36	7	XVEL2G7	6		
XVEC37	7	XVEL2M3	6		
XVEC5B3	7	XVEL2M4	6		
XVEC5B4	7	XVEL2M5	6		
XVEC5B5	7	XVEL2M6	6		
XVEC5B6	7	XVEL2M7	6		
XVEC5B7	7	XVEL33	6		
XVEC5G3	7	XVEL34	6		
XVEC5G4	7	XVEL35	6		

Schneider Electric USA

8001 Hwy 64 East
Knightdale, NC, 27545
1-888-SquareD
(1-888-778-2733)
www.us.SquareD.com

Schneider Electric Canada

19 Waterman Avenue,
M4B 1 Y2
Toronto, Ontario
1-800-565-6699
www.schneider-electric.ca

9001CT0408 © 2004 Schneider Electric All Rights Reserved