

MG24456 Supplementary Protector

SUPPLEMENTARY PROTECTOR , 480Y/277VAC, 50A, CIRCUIT BREAKER TYPE: STANDARD

Image not available

- [Product Information](#)

Features and Specifications

For Use With: OEM Panels

Approvals: UL 1077 Recognized, IEC 60947-2 Rated

Catalog Reference Number: 0860CT0201

Circuit Breaker Type: Standard

Ampere Rating: 50A

General Application: Overcurrent protection within appliances or electrical equipment where branch circuit breaker protection is provided or not required

Marketing Trade Name: Multi 9

Voltage Rating: 480Y/277VAC

Mounting Type: DIN Rail (35mm)

Weight: 7.70 Ounces

Number of Poles: 2-Pole

Short Circuit Current Rating: 10kA@240VAC - 5kA@480Y/277VAC

Terminal Type: Line: Box Lug - Load: Box Lug

Trip Curve: C Curve - Magnetic operates between 7 to 10 times

Type: C60N

Width: 1.42 Inches (36mm)

Height: 3.19 Inches (81mm)

Wire Size: #14 to #2 AWG (Cu)

Depth: 3.00 Inches (76mm)

Ordering and Shipping Information

- **Category 00908 - Supplemental Circuit Protectors, 1 Pole: 15 - 63 Amp, 2 Pole: 1 - 63 Amp, 3 Pole: 1 - 63 Amp, 4 Pole: 1 - 63 Amp, Type Multi 9 C60**
- **Discount Schedule DE2**
- **Article Number 785901346425**
- **Package Qty 1**
- **Weight (lbs.) 0.56**
- **Availability Code S**
- **Returnability Y**

1 POLE (277VAC/65VDC)			
RATING (AMPS)	CATALOG NUMBER		
	B CURVE	C CURVE	D CURVE
1	MG24110	MG24425	MG24500
2	MG24111	MG24426	MG24501
3	MG24112	MG24427	MG24502
4	MG24113	MG24428	MG24503
6	MG24114	MG24430	MG24504
8	MG24115	MG24431	MG24505
10	MG24116	MG24432	MG24506
13	MG24117	MG24433	MG24507
16	MG24118	MG24434	MG24508
20	MG24119	MG24435	MG24509
25	MG24120	MG24436	MG24510
32	MG24121	MG24437	MG24511
40	MG24122	MG24438	MG24512
50	MG24123	MG24439	MG24513
63	MG24124	MG24440	MG24514

3 POLE (240VAC/480Y,277VAC)			
RATING (AMPS)	CATALOG NUMBER		
	B CURVE	C CURVE	D CURVE
1	MG24140	MG24459	MG24532
2	MG24141	MG24460	MG24533
3	MG24142	MG24461	MG24534
4	MG24143	MG24462	MG24535
6	MG24144	MG24464	MG24536
8	MG24145	MG24465	MG24537
10	MG24146	MG24466	MG24538
13	MG24147	MG24467	MG24539
16	MG24148	MG24468	MG24540
20	MG24149	MG24469	MG24541
25	MG24150	MG24470	MG24542
32	MG24151	MG24471	MG24543
40	MG24152	MG24472	MG24544
50	MG24153	MG24473	MG24545
63	MG24154	MG24474	MG24546

2 POLE (240VAC/480Y,277VAC/125VDC)			
RATING (AMPS)	CATALOG NUMBER		
	B CURVE	C CURVE	D CURVE
1	MG24125	MG24442	MG24516
2	MG24126	MG24443	MG24517
3	MG24127	MG24444	MG24518
4	MG24128	MG24445	MG24519
6	MG24129	MG24447	MG24520
8	MG24130	MG24448	MG24521
10	MG24131	MG24449	MG24522
13	MG24132	MG24450	MG24523
16	MG24133	MG24451	MG24524
20	MG24134	MG24452	MG24525
25	MG24135	MG24453	MG24526
32	MG24136	MG24454	MG24527
40	MG24137	MG24455	MG24528
50	MG24138	MG24456	MG24529
63	MG24139	MG24457	MG24530

4 POLE (240VAC/480Y,277VAC)			
RATING (AMPS)	CATALOG NUMBER		
	B CURVE	C CURVE	D CURVE
1	MG24155	MG24476	MG24548
2	MG24156	MG24477	MG24549
3	MG24157	MG24478	MG24550
4	MG24158	MG24479	MG24551
6	MG24159	MG24481	MG24552
8	MG24160	MG24482	MG24553
10	MG24161	MG24483	MG24554
13	MG24162	MG24484	MG24555
16	MG24163	MG24485	MG24556
20	MG24164	MG24486	MG24557
25	MG24165	MG24487	MG24558
32	MG24166	MG24488	MG24559
40	MG24167	MG24489	MG24560
50	MG24168	MG24490	MG24561
63	MG24169	MG24491	MG24562

TRIPPING CHARACTERISTICS (MAGNETIC SETTINGS):

- B CURVE - 3.2 and 4.8 times ampere rating
- C CURVE - 7 and 10 times ampere rating
- D CURVE - 10 and 14 times ampere rating

WEIGHT

- 1 POLE (3.85oz./110g)
- 2 POLE (7.70oz./220g)
- 3 POLE (11.55oz./330g)
- 4 POLE (15.40oz./440g)

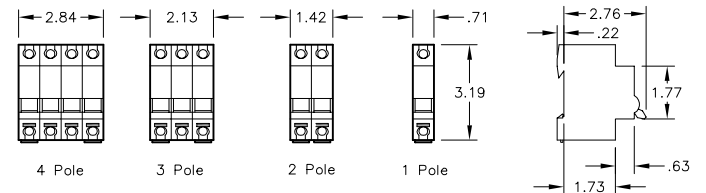

C60 Accessories

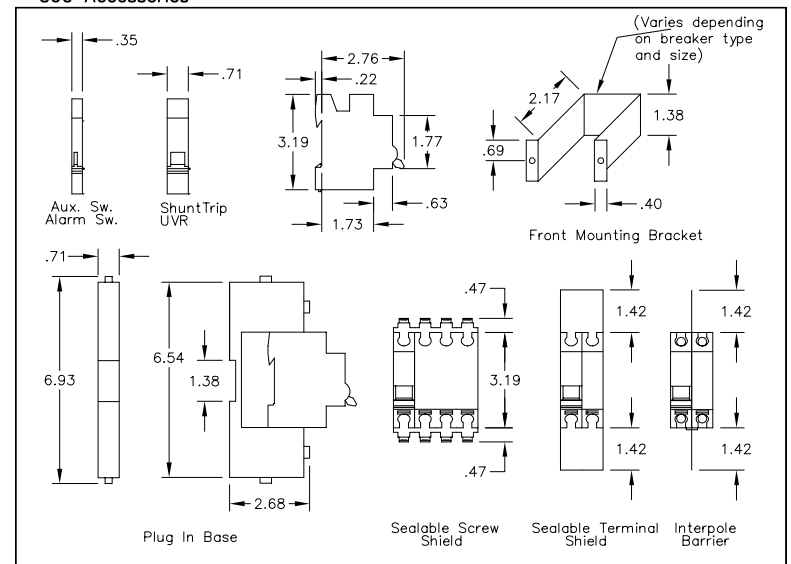

Catalog Number: C60N
 Ratings: SEE CHART
 UL File/CCN: E90509
 CSA File/Class: LR80849
 Meets Standards: IEC 947.2/VDE 0660
 Weight: SEE CHART
 Wire Size: 1 to 25A #18-#4AWG/32 to 63A #18-#2AWG
 Terminal torque: -
 Mounting Hwd.: 35mm DIN rail or front mounted

"THE SQUARE D COMPANY HAS PROPRIETARY RIGHTS TO THE INFORMATION CONTAINED HEREON. THIS INFORMATION REMAINS THE PROPERTY OF SQUARE D COMPANY AND MAY BE USED ONLY IN CONFORMANCE WITH INSTRUCTIONS ISSUED BY SQUARE D COMPANY. USER SHOULD VERIFY DRAWINGS ARE TO THE LATEST/CURRENT REVISION PRIOR TO INCORPORATING IN A DESIGN FILE."

DO NOT SCALE DRAWING
 UNLESS OTHERWISE SPECIFIED DIMENSIONS ARE IN INCHES

THIRD ANGLE PROJECTION
 TOLERANCES UNLESS OTHERWISE SPECIFIED 2 PLACE DECIMALS ± .01

MULTI 9 SUPPLEMENTARY PROTECTORS / ACCESSORIES C60N



DWG# NO. MULTI9_1-4P_63A_OUTLINE_001

Section 1—Introduction

Multi 9™ Products for Equipment Applications

The Multi 9 modular system of miniature circuit breakers and supplementary protectors, accessories, and peripherals provides complete protection of equipment or especially sensitive circuits within the equipment. Installation labor and space are both minimized by the modular architecture of the Multi 9 system, whether a single protective device or multiple devices with their accessories are being used.

Schneider Electric offers an extensive line of UL 489 Circuit Breakers and UL 1077 Supplementary Protectors. In addition, a variety of IEC certified Circuit Breakers and Accessories are available for OEM's whose products are destined for export beyond North America. To an OEM, this means that one family of electrical protection products can be used regardless of equipment destination.

The Standards include:

- UL 489 Standard for Circuit Breakers
- UL 489A Standard for DC Communication Applications
- UL 1077 Standard for Supplementary Protectors
- UL 1053 Ground Fault Sensing and Relaying Equipment
- IEC 60947-2 Low-voltage switchgear and controlgear - Part 2: Circuit-breakers
- CSA C22.2 No. 5 Standard for Circuit Breakers
- CSA C22.2 No. 235 Supplementary Protectors
- CCC Pending 4Q2007
- C60 Miniature Circuit Breakers are RoHS Compliant

Potential applications include semi-conductor machines, communication equipment, process control panels, computers, medical equipment, electronic controls, transformers, power supplies, and other electrical equipment.

System Flexibility

The Multi 9 System includes an extensive line of field-installable accessories. Plug-on electrical auxiliaries include shunt trip, undervoltage release, auxiliary switch, and alarm switch. Other protection devices include residual current devices, dc circuit breakers, and switches. Control and display devices include signal lamps, push buttons, and motor operators. There are also mechanical accessories for locking, operating, shielding, mounting, etc. The following diagram shows many of the Multi 9 system accessories.

Figure 1: Functional Diagram of Multi 9 System

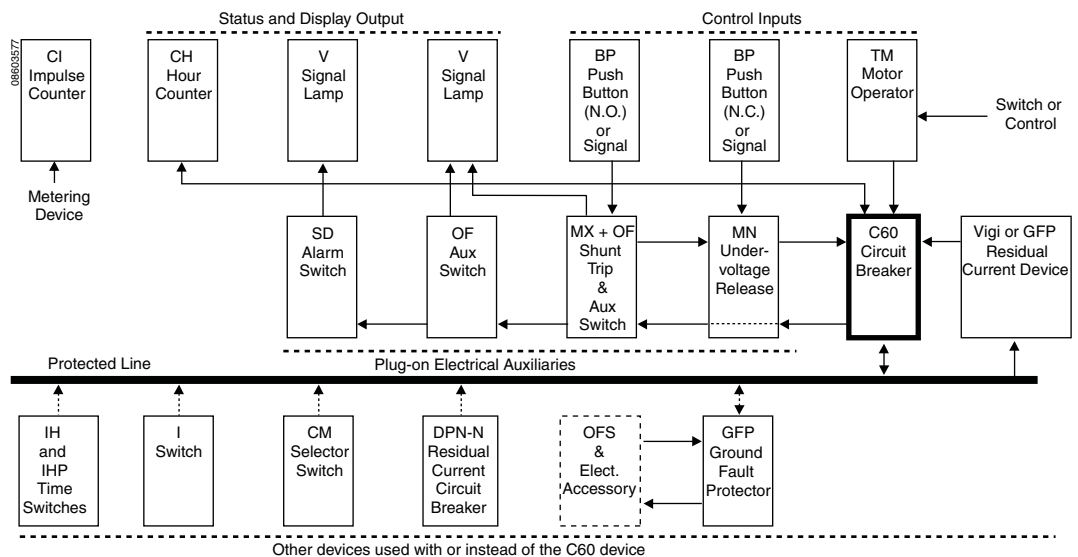

Multi 9™ System Catalog

Section 2—UL and CSA Rated Protection Devices

Figure 4: UL 1077 Recognized C60N Supplementary Protectors



Table 3: Specifications for UL 1077 Recognized Supplementary Protectors

Ratings per UL Standards			UL 1077 C60N			
Number of Poles			1P	2P	3P	4P
Rated Current at 77°F (25°C)			0.5–63 A	0.5–63 A	0.5–63 A	0.5–63 A
Interrupting Ratings as per UL 1077	50/60 Hz	120 Vac	10 kA	—	—	—
		240 Vac	10 kA	10 kA	10 kA	10 kA
		277 Vac	5 kA	—	—	—
		480Y/277 Vac	—	5 kA	5 kA	5 kA
—	—	65 Vdc	10 kA	—	—	—
		125 Vdc	—	10 kA	—	—
Ultimate Breaking Capacity (I_{cu}) as per IEC 60947-2	50/60 Hz	240 Vac	10 kA	20 kA	20 kA	20 kA
		415 Vac	3 kA	10 kA	10 kA	10 kA
		440 Vac	—	6 kA	6 kA	6 kA
Service Breaking Capacity (I_{cs}) (% I_{cu})			75%	75%	75%	75%
Plug-On Auxiliary Modules with Mechanical Linkage:			MN Undervoltage Trip MX + OF Shunt Trip/Auxiliary Switch OF Auxiliary Switch SD Alarm Switch			
Magnetic Setting	B Curve		Between 3.2 and 4.8 Times Ampere Rating			
	C Curve		Between 7 and 10 Times Ampere Rating (Between 7 and 14 for dc)			
	D Curve		Between 10 and 14 Times Ampere Rating (No DC Rating for D Curve)			
Dimensions (in./mm)	Width		0.71/18	1.42/36	2.13/54	2.84/72
	Height		3.19/81	3.19/81	3.19/81	3.19/81
	Depth		3.00/76	3.00/76	3.00/76	3.00/76
Weight (oz./g)			3.85/110	7.70/220	11.55/330	15.40/440

Multi 9™ System Catalog

Section 2—UL and CSA Rated Protection Devices

UL 1077 Recognized C60 Supplementary Protectors

The UL 1077 products are intended for use as supplementary protectors to provide overcurrent protection within appliances or electrical equipment where branch circuit protection is already provided or is not required.

As shown in the table of catalog numbers below, the UL 1077 Recognized products are available in B, C and D curves. They include devices ranging from 0.5 A to 63 A.

Figure 6: UL 1077 Recognized C60N Supplementary Protectors

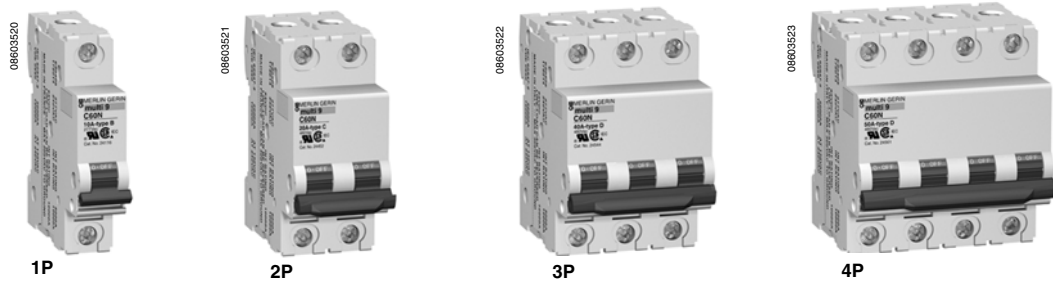

Table 13: Specifications for UL 1077 Recognized C60 Supplementary Protectors

Package Size	0.71 in. (18 mm)	Width per Pole
Voltage	Nominal Voltage	480Y/277 Vac
	High Voltage Withstand	6 kV
Connection, Box Lug UL 486A File No. E90509 Pending	Cable: 0.5–25 A: 14–4 AWG (2–25 mm ²) Cu Only	Torque 22 lb-in (2.49 N•m)
	Cable: 30–63 A: 14–2 AWG (2–35 mm ²) Cu Only	Torque 31 lb-in (3.50 N•m)
Optional Ring Terminal Kit	Screw Dia.: 0.2 in. (5mm)	Torque 18 lb-in (2.03 N•m)
Mounting	35 mm DIN rail	
Time-Current Curves	B, C, and D Curves	
Degree of Protection as per IEC 68-2-30	Case	IP40 as per IEC 529
	Terminals	IP20
Temperatures	Calibration	25°C (77°F)
	Storage	-40 to 80°C (-40 to 176°F)
	Operating	-30 to 70°C (-22 to 158°F)
Tropicalization	Treatment 2	Relative Humidity: 95% at 131°F (55°C)
Number of Operating Cycles:	Electrical (O-C)	10,000 at 0.5–63 A

See Specification Table 3 for dimensions, weights and interrupting ratings

Standards

- UL 1077 Circuit Breaker, File No. E90509
- CSA C22.2 No. 235-M89 File No. 179014
- IEC 60947-2
- VDE 0660
- CE Marked

Standard Features

- Trip-free mechanism: Contacts cannot be held in the on position when the C60 is tripped automatically.
- Positive indication of contact disconnect. Green mechanical indication on front face of device shows that all poles are open.
- B curve: Overcurrent protection for sensitive equipment (computers, electronic devices, etc.). Magnetic release operates between 3.2 and 4.8. (between 3.2 and 6.8 for dc)
- C curve: Overcurrent protection for all application types. Magnetic release operates from 7 to 10 times ampere rating. (between 7 and 14 for dc)
- D curve: Overcurrent protection for loads with high inrush currents (motors, transformers). Magnetic release operates between 10 and 14 times ampere rating. (no dc rating)
- Allows locking in O-OFF position using padlock attachment.
- Suitable for reverse feeding.

For rating and dimensional information, see Table 3, “Specifications for UL 1077 Recognized Supplementary Protectors”

Catalog Numbers

Table 14: Catalog Numbers for UL 1077 Recognized C60N Supplementary Protectors

Rating	B Curve				C Curve				D Curve			
	1P	2P	3P	4P	1P	2P	3P	4P	1P	2P	3P	4P
0.5 A	—	—	—	—	MG17411	—	—	—	MG17421	—	—	—
1 A	MG24110	MG24125	MG24140	MG24155	MG24425	MG24442	MG24459	MG24476	MG24500	MG24516	MG24532	MG24548
1.2 A	MG17402	MG17432	—	—	MG17412	MG17442	—	—	MG17422	MG17452	—	—
1.5 A	MG17403	MG17433	—	—	MG17413	MG17443	—	—	MG17423	MG17453	—	—
2 A	MG24111	MG24126	MG24141	MG24156	MG24426	MG24443	MG24460	MG24477	MG24501	MG24517	MG24533	MG24549
3 A	MG24112	MG24127	MG24142	MG24157	MG24427	MG24444	MG24461	MG24478	MG24502	MG24518	MG24534	MG24550
4 A	MG24113	MG24128	MG24143	MG24158	MG24428	MG24445	MG24462	MG24479	MG24503	MG24519	MG24535	MG24551
5 A	MG17404	MG17434	—	—	MG17414	MG17444	—	—	MG17424	MG17454	—	—
6 A	MG24114	MG24129	MG24144	MG24159	MG24430	MG24447	MG24464	MG24481	MG24504	MG24520	MG24536	MG24552
7 A	MG17405	MG17435	—	—	MG17415	MG17445	—	—	MG17425	MG17455	—	—
8 A	MG24115	MG24130	MG24145	MG24160	MG24431	MG24448	MG24465	MG24482	MG24505	MG24521	MG24537	MG24553
10 A	MG24116	MG24131	MG24146	MG24161	MG24432	MG24449	MG24466	MG24483	MG24506	MG24522	MG24538	MG24554
13 A	MG24117	MG24132	MG24147	MG24162	MG24433	MG24450	MG24467	MG24484	MG24507	MG24523	MG24539	MG24555
15 A	MG17406	MG17436	MG17461	—	MG17416	MG17446	MG17466	—	MG17426	MG17456	MG17471	—
16 A	MG24118	MG24133	MG24148	MG24163	MG24434	MG24451	MG24468	MG24485	MG24508	MG24524	MG24540	MG24556
20 A	MG24119	MG24134	MG24149	MG24164	MG24435	MG24452	MG24469	MG24486	MG24509	MG24525	MG24541	MG24557
25 A	MG24120	MG24135	MG24150	MG24165	MG24436	MG24453	MG24470	MG24487	MG24510	MG24526	MG24542	MG24558
30 A	MG17407	MG17437	MG17462	—	MG17417	MG17447	MG17467	—	MG17427	MG17457	MG17472	—
32 A	MG24121	MG24136	MG24151	MG24166	MG24437	MG24454	MG24471	MG24488	MG24511	MG24527	MG24543	MG24559
35 A	MG17408	MG17438	MG17463	—	MG17418	MG17448	MG17468	—	MG17428	MG17458	MG17473	—
40 A	MG24122	MG24137	MG24152	MG24167	MG24438	MG24455	MG24472	MG24489	MG24512	MG24528	MG24544	MG24560
50 A	MG24123	MG24138	MG24153	MG24168	MG24439	MG24456	MG24473	MG24490	MG24513	MG24529	MG24545	MG24561
60 A	MG17409	MG17439	MG17464	—	MG17419	MG17449	MG17469	—	MG17429	MG17459	MG17474	—
63 A	MG24124	MG24139	MG24154	MG24169	MG24440	MG24457	MG24474	MG24491	MG24514	MG24530	MG24546	MG24562

UL 1077 Supplementary Protectors

Figure 29: C60 UL 1077 Supplementary Protectors

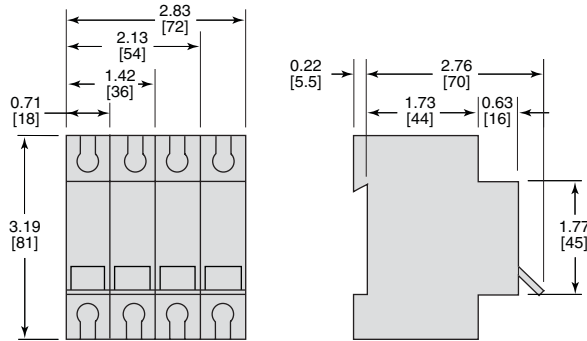

IEC Rated Circuit Breakers

Figure 30: IEC DPN-N Circuit Breaker

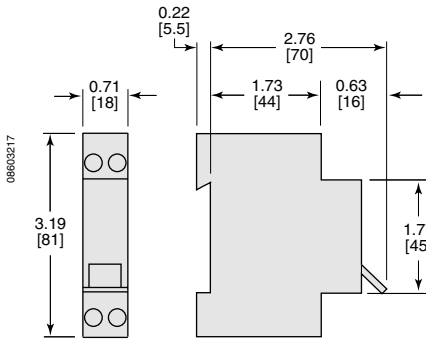

Figure 31: C60 IEC Circuit Breakers

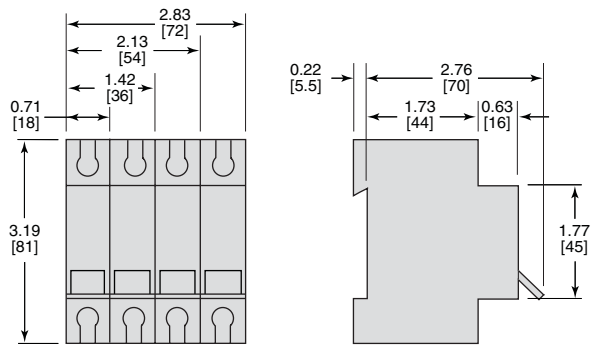
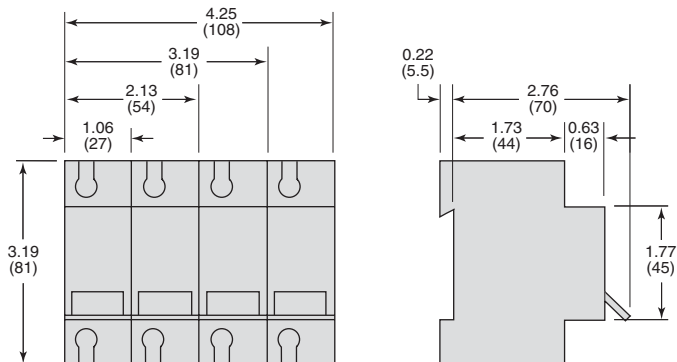

Figure 32: C120 IEC Circuit Breaker



Dimensions: in.
(mm)