

# 60120 Circuit Breaker

MINIATURE CIRCUIT BREAKER , 120/240VAC, 2A, CIRCUIT BREAKER TYPE: STANDARD

Image not available

- [Product Information](#)

## Features and Specifications

**Circuit Breaker Type:** Standard

**Catalog Reference Number:** 0860CT0201

**For Use With:** OEM Panels and Enclosures

**Enclosure Rating:** IP40

**General Application:** Short circuit and overcurrent protection

**Marketing Trade Name:** Multi 9

**Ampere Rating:** 2A

**Approvals:** UL489 Listed - CSA 22.2 #5.1 Certified - IEC Rated 60947-2

**Specific Application:** Protection for loads with high inrush currents (motors, transformers, etc.)

**HACR Rated:** Yes

**Voltage Rating:** 120/240VAC

**Mounting Type:** Flush, Surface or DIN Rail (35mm)

**Weight:** 4.40 Ounces

**Number of Poles:** 1-Pole

**Short Circuit Current Rating:** 5kA@240VAC - 10kA@120VAC

**Terminal Type:** Line: Box Lug - Load: Box Lug

**Type:** C60N

**Trip Curve:** D Curve - Magnetic operates between 10 to 14 times

**Wire Size:** #18 to #4 AWG

**Width:** 0.71 Inches (18mm)

**Depth:** 3.00 Inches (76mm)

**Height:** 4.21 Inches (107mm)

## Ordering and Shipping Information

- **Category** 00915 -
- **Discount Schedule** DE2
- **Article Number** 785901209874
- **Package Qty** 1
- **Weight (lbs.)** 0.29
- **Availability Code** S
- **Returnability** Y

## Section 1—Introduction

### Multi 9™ Products for Equipment Applications

The Multi 9 modular system of miniature circuit breakers and supplementary protectors, accessories, and peripherals provides complete protection of equipment or especially sensitive circuits within the equipment. Installation labor and space are both minimized by the modular architecture of the Multi 9 system, whether a single protective device or multiple devices with their accessories are being used.

Schneider Electric offers an extensive line of UL 489 Circuit Breakers and UL 1077 Supplementary Protectors. In addition, a variety of IEC certified Circuit Breakers and Accessories are available for OEM's whose products are destined for export beyond North America. To an OEM, this means that one family of electrical protection products can be used regardless of equipment destination.

The Standards include:

- UL 489 Standard for Circuit Breakers
- UL 489A Standard for DC Communication Applications
- UL 1077 Standard for Supplementary Protectors
- UL 1053 Ground Fault Sensing and Relaying Equipment
- IEC 60947-2 Low-voltage switchgear and controlgear - Part 2: Circuit-breakers
- CSA C22.2 No. 5 Standard for Circuit Breakers
- CSA C22.2 No. 235 Supplementary Protectors
- CCC Pending 4Q2007
- C60 Miniature Circuit Breakers are RoHS Compliant

Potential applications include semi-conductor machines, communication equipment, process control panels, computers, medical equipment, electronic controls, transformers, power supplies, and other electrical equipment.

### System Flexibility

The Multi 9 System includes an extensive line of field-installable accessories. Plug-on electrical auxiliaries include shunt trip, undervoltage release, auxiliary switch, and alarm switch. Other protection devices include residual current devices, dc circuit breakers, and switches. Control and display devices include signal lamps, push buttons, and motor operators. There are also mechanical accessories for locking, operating, shielding, mounting, etc. The following diagram shows many of the Multi 9 system accessories.

**Figure 1: Functional Diagram of Multi 9 System**



# Multi 9™ System Catalog

## Section 1—Introduction

### Advantages

Multi 9 C60 circuit breakers and supplementary protectors provide several features which are important to OEMs. These include:

- Small, compact size
- Easy installation on DIN rails
- Limits let-thru current
- Resetability, more convenient than fuses
- Electrical auxiliaries for control and status information
- Extensive variety of accessories

**Figure 2: UL 489 Listed Multi 9 C60 Circuit Breakers**



**Better Protection**—Multi 9 supplementary protectors and miniature circuit breakers limit let-through current, providing faster separation of the component from the fault, thereby reducing system damage.

**More Selection**—More ratings compatible with low-power electronic circuits are available in the range from 0.5 to 10 A. Others are provided in convenient steps, up to 63 A for the C60 products.

**Reduction of Nuisance Tripping**—Available with different trip characteristics to meet system needs: B, C and D curves, depending on the model.

**Panel Space Savings**—Multi 9 products are compact. Width per pole is only 0.71 in. (18 mm) for the C60 circuit breaker. All of the products are built in a consistent format with incremental widths of 0.35 in. (9 mm) (therefore the name Multi 9).

**Easy Installation**—The Multi 9 products mount easily onto a 35 mm DIN mounting rail. Large box lug terminals (pressure plate type) are suitable for use with copper wiring up to 2 AWG for C60 circuit breakers and supplemental protectors.

**Reverse Feeding**—Reverse feeding of line power is permitted.

**Reliability**—Each C60 miniature circuit breaker has an endurance of 10,000 operation cycles and voltage withstand of 6000 V impulse rating.

**World-Wide Availability**—The Multi 9 products are available and supported throughout the world by Schneider Electric.

**From the Power Distribution Specialists**—Schneider Electric can be your single source of protection equipment, with a comprehensive line of products for OEM products or the factory. In addition to the Multi 9 circuit breakers and supplementary protectors, these products include the following:

- QO® and QOU Miniature Circuit Breakers 10–125 A
- Compact® Molded Case Circuit Breakers 15–3200 A
- Powerpact® Electronic Trip Circuit Breakers 250–2500 A
- Masterpact® Universal Power Circuit Breakers 250–6300 A

## Section 2—UL and CSA Rated Protection Devices

The Multi 9 system includes several families of miniature circuit protection devices that have the UL ratings required in the United States and some other countries. The products are summarized below and are described in detail on the following pages. They include the following families:

- UL Listed C60 240 V Circuit Breakers (UL 489 and CSA C22.2 No. 5)
- UL Listed C60 480 V Circuit Breakers (UL 489 and CSA C22.2 No. 5)
- UL Listed C60 Circuit Breakers for use in Communication Equipment (UL 489A)
- UL Recognized C60 Supplementary Protectors (UL 1077 and CSA C22.2 No. 235)

**NOTE:** Protection devices with only IEC ratings are described in Section 3, while accessories for both the UL and IEC devices are described in Section 5.

**Table 2: Specifications for UL 489 and 489A Listed C60 Circuit Breakers**

Ratings per UL Standards		UL 489 C60 (240 Vac)			UL 489 C60 (480Y/277 Vac)			UL 489A C60 (60 Vdc)	
		1P	2P	3P	1P	2P	3P	1P	
Number of Poles		1P	2P	3P	1P	2P	3P	1P	
Rated Current at 77°F (25°C)		0.5–35 A	0.5–35 A	0.5–35 A	0.5–20 A	1–20 A	1–20 A	0.5–63 A	
Interrupting Ratings as per UL 489	AC 50/60 Hz	120 V	10 kA	—	—	10 kA	—	—	—
		240 V	10 kA	10 kA	10 kA	10 kA	10 kA	10 kA	—
		277 V	—	—	—	10 kA	10 kA	10 kA	—
		480Y/277 V	—	—	—	10 kA	10 kA	10 kA	—
	DC	60 V	10 kA	10 kA	—	—	—	—	10 kA
		125 V	—	10 kA	—	—	—	—	—
Ultimate Breaking Capacity ( $I_{cu}$ ) as per IEC 60947-2	AC 50/60 Hz	240 V	10 kA	20 kA	20 kA	10 kA	10 kA	10 kA	—
		415 V	10 kA	10 kA	10 kA	10 kA	10 kA	10 kA	—
		440 V	—	6 kA	6 kA	—	6 kA	6 kA	—
Service Breaking Capacity ( $I_{cs}$ ) (% $I_{cu}$ )		75%	75%	75%	75%	75%	75%	75%	
Magnetic Setting (Times Ampere Rating)	B curve	—			—			—	
	C curve	7 to 10			7 to 10			7 to 14	
	D curve	10 to 14			10 to 14			—	
Dimensions (in./mm)	Width	0.71/18	1.42/36	2.13/54	0.71/18	1.42/36	2.13/54	0.71/18	
	Height	box/box	4.21/107	4.21/107	4.21/107	5.56/141	5.56/141	5.56/141	3.19/81
		ring/ring <sup>1</sup>	4.86/123.4	4.86/123.4	4.86/123.4	5.56/141	5.56/141	5.56/141	—
		box/ring	4.54/115	4.54/115	4.54/115	—	—	—	—
Depth	3.00/76	3.00/76	3.00/76	3.00/76	3.00/76	3.00/76	3.00/76		
Weight (oz./g) max.	box/box	4.4/136	8.7/271	13.1/407	5.3 (166)	10.6/332	15.9 (498)	3.85/110	
	ring/ring	5.2/161	10.3/321	15.5/482	5.3 (166)	10.6/332	15.9 (498)	—	
	box/ring	4.8/148	9.5/297	14.3/445	—	—	—	—	

<sup>1</sup> Fingersafe 240 V C60 circuit breaker ring terminal dimensions are same as the 480V C60 circuit breaker.

## UL 489 Listed 240 Vac C60 Circuit Breakers (AC)

A selected range of Multi-9 circuit breakers rated 240 V are UL 489 Listed. Unlike UL 1077 Supplementary Protectors, these UL 489 circuit breakers can be used for branch circuit protection as required by the National Electrical Code.

As shown in tables Table 5 and Table 6, the UL 489 Listed products are available in C and D curves. They include devices ranging from 0.5 to 35 A.

### UL 489 Listed Multi 9 C60 Circuit Breakers



**Table 4: Specifications for UL 489 240 V Listed C60N Circuit Breakers**

High Voltage Withstand	6 kV	
Connector: Box Lug	Rating	UL 486A File No. E216919 (Use with Copper Wire Only)
	Connection	0.5–25 A: 14–4 AWG (2–25 mm <sup>2</sup> ) Cables Torque to 22 lb-in. (2.48 N•m) 30–35 A: 14–2 AWG (1–35 mm <sup>2</sup> ) Cables Torque to 31 lb-in. (3.52 N•m)
Connector: Ring Tongue	Use Single UL Listed or CSA Certified Insulated Ring Tongue Only	Screw dia. 0.2 in. (5 mm) Torque to 18 lb-in. (2.03 N•m)
	Max Ring Terminal Width	0.54 in. (14 mm)
Mounting	35 mm DIN rail	
Degree of Protection	Case	IP40 as per IEC 529
	Terminals	IP20
Temperatures	Calibration	25°C (77°F)
	Storage	-40 to 80°C (-40 to 176°F)
	Operating	-30 to 70°C (-22 to 158°F)
Plug-On Auxiliary Modules with Mechanical Linkage:	MN Undervoltage Trip	
	MX + OF Shunt Trip/Auxiliary Switch	
	OF Auxiliary Switch	
	SD Alarm Switch	
Tropicalization	Treatment 2	Relative Humidity: 95% at 131°F (55°C)
Number of Operating Cycles	Electrical (O-C)	6,000 load, 4,000 no-load

See specifications Table 2 for dimensions, weights and interrupting ratings

### Standard Features

- Fast closing: Allows increased withstand to the high inrush currents of some loads.
- Trip-free mechanism: Contacts cannot be held in the I-ON position when the C60 circuit breaker is tripped automatically.
- Positive indication of contact disconnect. Green mechanical indication on front face of circuit breaker shows that all poles are open.
- C curve: Overcurrent protection for all application types. Magnetic release operates from 7 to 10 times ampere rating (7 to 14 for DC applications).

# Multi 9™ System Catalog

## Section 2—UL and CSA Rated Protection Devices

- D curve: Overcurrent protection for loads with high inrush currents (motors, transformers). Magnetic release operates between 10 and 14 times ampere rating (no dc rating for D curve).
- Suitable for reverse feeding.
- Allows locking in O-OFF position using padlock attachment.

### Connections

Three versions of field wiring connectors are available for the 240 Vac UL 489 Listed devices:

- Box lug, meeting UL 486A requirements
- Ring tongue terminal with 5 mm screw
- Ring Tongue terminals with Fingersafe (IP20) shrouds

The circuit breakers can be ordered with the following combinations of connectors:

- Line terminal box lug/load terminal box lug
- Line terminal ring tongue/load terminal ring tongue (for fingersafe version, add -F suffix to catalog number)
- Line terminal box lug/load terminal ring tongue

**Figure 5: Connection Options for 240 Vac UL 489 Listed Devices**



### Standards

- UL 489 Circuit Breaker: File No. E215117
- Single pole 15–20 A is UL Listed as SWD (switching duty).
- 1-, 2-, and 3-pole 15–35 A are HID (high intensity discharge) rated.
- CSA C22.2 No. 5.1 Circuit Breakers: File No. 179014
- IEC 60947-2
- CE Marked

## Multi 9™ System Catalog Section 2—UL and CSA Rated Protection Devices

### Catalog Numbers

**Table 5: Catalog Numbers for C Curve, UL 489 Listed 240 Vac C60 Miniature Circuit Breakers (Box Lug and Ring Tongue Terminal Combinations)**

Rating	1P			2P			3P		
	Box/Box	Ring/Ring <sup>1</sup>	Box/Ring	Box/Box	Ring/Ring <sup>1</sup>	Box/Ring	Box/Box	Ring/Ring <sup>1</sup>	Box/Ring
0.5 A	60100	60200	60300	60134	60234	60334	—	—	—
1 A	60101	60201	60301	60135	60235	60335	60168	60268	60368
1.5 A	60102	60202	60302	60136	60236	60336	60169	60269	60369
2 A	60103	60203	60303	60137	60237	60337	60170	60270	60370
3 A	60104	60204	60304	60138	60238	60338	60171	60271	60371
4 A	60105	60205	60305	60139	60239	60339	60172	60272	60372
5 A	60106	60206	60306	60140	60240	60340	60173	60273	60373
6 A	60107	60207	60307	60141	60241	60341	60174	60274	60374
7 A	60108	60208	60308	60142	60242	60342	60175	60275	60375
8 A	60109	60209	60309	60143	60243	60343	60176	60276	60376
10 A	60110	60210	60310	60144	60244	60344	60177	60277	60377
13 A	60111	60211	60311	60145	60245	60345	60178	60278	60378
15 A	60112	60212	60312	60146	60246	60346	60179	60279	60379
20 A	60113	60213	60313	60147	60247	60347	60180	60280	60380
25 A	60114	60214	60314	60148	60248	60348	60181	60281	60381
30 A	60115	60215	60315	60149	60249	60349	60182	60282	60382
35 A	60116	60216	60316	60150	60250	60350	60183	60283	60383

<sup>1</sup> IP-20 Fingersafe ring tongue terminals may be ordered with an F suffix (example: 60210F)

**Table 6: Catalog Numbers for D Curve, UL 489 Listed 240 Vac C60 Miniature Circuit Breakers (Line/Load as Box Lug or Ring Tongue Terminals)**

Rating	1P			2P			3P		
	Box/Box	Ring/Ring <sup>1</sup>	Box/Ring	Box/Box	Ring/Ring <sup>1</sup>	Box/Ring	Box/Box	Ring/Ring <sup>1</sup>	Box/Ring
0.5 A	60117	60217	60317	60151	60251	60351	—	—	—
1 A	60118	60218	60318	60152	60252	60352	60184	60284	60384
1.5 A	60119	60219	60319	60153	60253	60353	60185	60285	60385
2 A	60120	60220	60320	60154	60254	60354	60186	60286	60386
3 A	60121	60221	60321	60155	60255	60355	60187	60287	60387
4 A	60122	60222	60322	60156	60256	60356	60188	60288	60388
5 A	60123	60223	60323	60157	60257	60357	60189	60289	60389
6 A	60124	60224	60324	60158	60258	60358	60190	60290	60390
7 A	60125	60225	60325	60159	60259	60359	60191	60291	60391
8 A	60126	60226	60326	60160	60260	60360	60192	60292	60392
10 A	60127	60227	60327	60161	60261	60361	60193	60293	60393
13 A	60128	60228	60328	60162	60262	60362	60194	60294	60394
15 A	60129	60229	60329	60163	60263	60363	60195	60295	60395
20 A	60130	60230	60330	60164	60264	60364	60196	60296	60396
25 A	60131	60231	60331	60165	60265	60365	60197	60297	60397
30 A	60132	60232	60332	60166	60266	60366	60198	60298	60398
35 A	60133	60233	60333	60167	60267	60367	60199	60299	60399

<sup>1</sup> IP-20 Fingersafe ring tongue terminals may be ordered with an F suffix (example: 60210F)

**NOTE:** UL 489 Listed Multi 9 circuit breakers are calibrated at 25°C (77°F). Please refer to the rating tables (page 80) for applications at temperatures greater than 25°C (77°F).

**NOTE:** The NEC requires that the continuous load applied to the circuit breaker shall not exceed 80% of the circuit breaker ampere rating.

# Multi 9™ System Catalog

## Section 2—UL and CSA Rated Protection Devices

### UL 489 Listed C60 Circuit Breakers (DC)

#### Overview

A portion of the range of UL 489 circuit breakers are also Listed by UL for use with dc circuits. The specifications are the same as the UL 489 circuit breakers, with the following exceptions:

- Number of poles: 1 and 2
- Time/current curve: C curve
- Magnetic setting of C curve: between 7 and 14 times ampere rating
- DC voltage (nominal): 1 pole—60 Vdc, 2 pole—125 Vdc
- Connection: box lug only (same torque)



**Table 9: Specifications for UL 489 C60 DC Circuit Breakers**

Ratings per UL Standards		UL 489 C60 (DC)	
Number of Poles		1	2
Rated Current (A) at 77°F (25°C)		60 Vdc	
Interrupting Ratings per UL 489 (kA)	60 Vdc	10	—
	125 Vdc	—	10
Service Breaking Capacity (Ics) (%Icu)		75%	75%
Magnetic Setting (Times Ampere Rating)	B curve	—	—
	C Curve	7 to 14	7 to 14
	D Curve	—	—
Dimensions	Width	0.71 in. (18 mm)	1.42 in. (36 mm)
	Height (Box/Box)	4.21 in. (107 mm)	4.21 in. (107 mm)
	Depth	3.00 in. (76 mm)	—
Weight (Max.)		4.4 oz. (136 g)	8.7 oz. (271 g)

#### Catalog Numbers

**Table 10: Catalog Numbers for UL 489 C60 Listed Miniature Circuit Breakers (DC)<sup>1</sup>**

Rating	C Curve		Rating	C Curve	
	1P, Box/Box	2P, Box/Box		1P, Box/Box	2P, Box/Box
0.5 A	60100	30134	10 A	60110	60144
1 A	60101	60135	13 A	60111	60145
1.5 A	60102	60136	15 A	60112	60146
2 A	60103	60137	20 A	60113	60147
3 A	60104	60138	25 A	60114	60148
4 A	60105	60139	30 A	60115	60149
5 A	60106	60140	35 A	60116	60150
6 A	60107	60141	40 A	60400	—
7 A	60108	60142	50 A	60401	—
8 A	60109	60143	63 A	60102	—

<sup>1</sup> The dc catalog numbers are the same as the UL 489 ac equivalents.





## Section 7—Dimensions

### UL 489 Listed C60 Circuit Breakers

**Figure 25: UL 489 Listed C60 240 Vac Circuit Breaker with Box Lug Terminals**

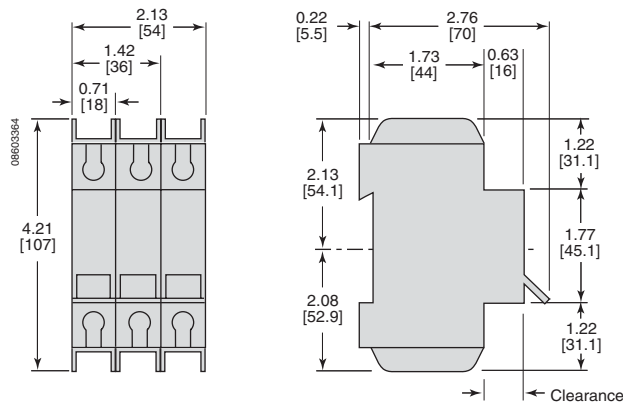

**Figure 26: UL 489 Listed C60 240 Vac Circuit Breaker with Ring Tongue Terminals**



**Figure 27: UL 489 C60 480 Vac and 240 Vac Circuit Breaker with Fingersafe Shields**

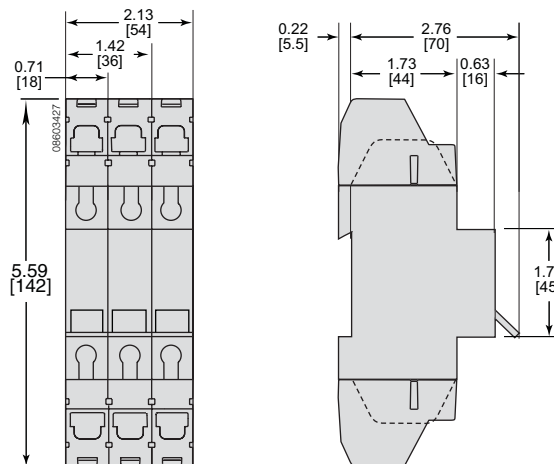

**Figure 28: UL 489A Listed C60 60 Vdc Circuit Breakers for DC Telecommunications Applications**

