

Path: [Home](#) > [Enclosure Index](#) > Translucent Blue Plastic - Miniature Hand Held



(click to enlarge)
**Assembled View
(Top)**









































(click to enlarge)
**Assembled View
(Bottom)**



(click to enlarge)
Open View

Key Features:

- Ideally suited for mounting small printed circuit boards or used as potting boxes.
- Molded in translucent blue ABS plastic (translucent to blue, white and near white LEDs, readouts & displays).
- Link here to the original [1551 series](#) (in solid black & gray ABS).
- Satin texture finish.
- Complete with lid and two self tapping black plated screws.
- 2 P.C. board standoffs molded into interior.
- Lap joint construction provides protection against access of dust and splashing water.
- Designed to meet IP54.
-  Link here to [photo tables](#) of each part number.

Part Number	Color	 PDF Reader File	AutoCAD .dwg File (zipped)	3D Solid Model .igs & .stp files (zipped)	Units	Length	Width	Enclosure Depth (With Lid)
1551NTBU	TransBlue	 301K	 296K	 330K	Inches	1.38	1.38	0.59
					mm	35	35	15
1551MTBU	TransBlue	 293K	 271K	 339K	Inches	1.38	1.38	0.79
					mm	35	35	20
1551QTBU	TransBlue	 301K	 319K	 349K	Inches	1.58	1.58	0.59
					mm	40	40	15
1551PTBU	TransBlue	 293K	 295K	 343K	Inches	1.58	1.58	0.79
					mm	40	40	20
1551FTBU	TransBlue	 292K	 299K	 313K	Inches	1.97	1.38	0.59
					mm	50	35	15
1551GTBU	TransBlue	 291K	 291K	 346K	Inches	1.97	1.38	0.79
					mm	50	35	20
1551STBU	TransBlue	 293K	 321K	 357K	Inches	1.97	1.97	0.59
					mm	50	50	15
1551RTBU	TransBlue	 291K	 317K	 348K	Inches	1.97	1.97	0.79
					mm	50	50	20
1551JTBU	TransBlue	 283K	 307K	 336K	Inches	2.36	1.38	0.59
					mm	60	35	15
1551HTBU	TransBlue	 273K	 283K	 340K	Inches	2.36	1.38	0.79
					mm	60	35	20
1551LTBU	TransBlue	 272K	 297K	 329K	Inches	3.15	1.58	0.59
					mm	80	40	15
1551KTBU	TransBlue	 271K	 297K	 316K	Inches	3.15	1.58	0.79
					mm	80	40	20

 Link here to [photo tables](#) of each part number

NOTES:

- Lid is apx. 0.12" (3 mm) deep.
- **Extra** self tapping lid screws are #4 x 1/2" (Qty 100 - Part number **1591TS100BK** - black)
- To secure P.C. board use self tapping #2 x 3/16" screws (Qty 100 - Part number **1551ATS100**) - not included with enclosure.

Top View of Assembly

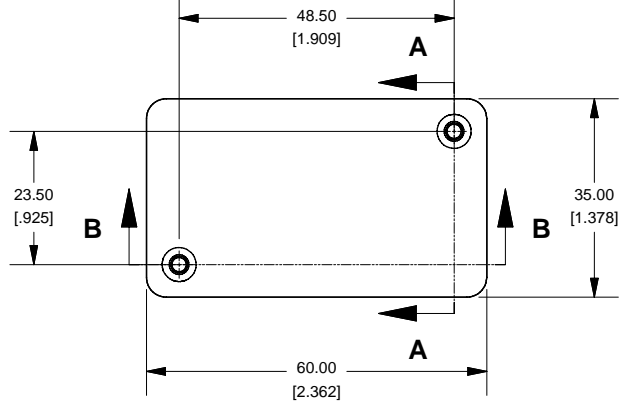

SECTION A-A End View of Assembly

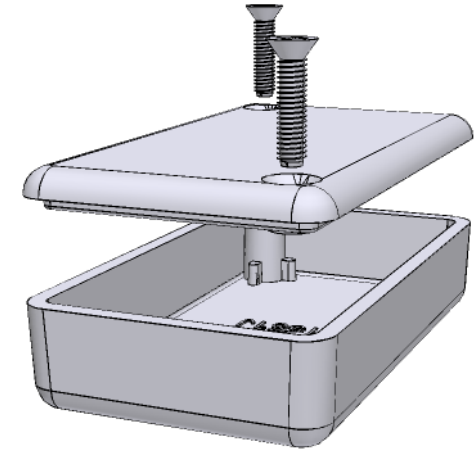
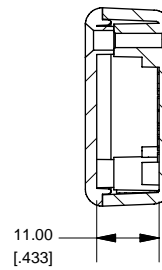

SECTION B-B Side View of Assembly

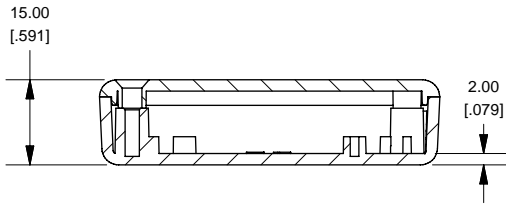

Top View Looking Inside Box

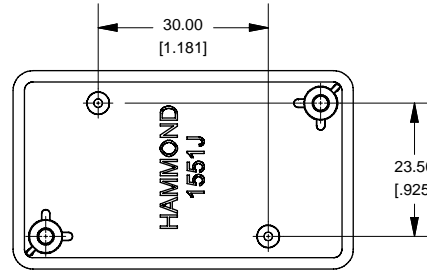

SECTION C-C Boss Heights

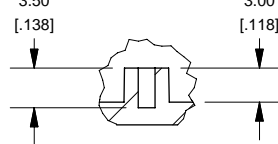

Lid

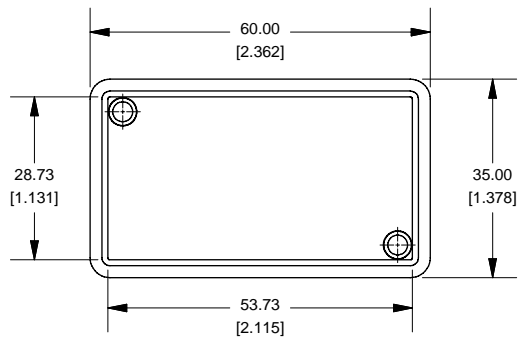

Maximum P.C. Board Size

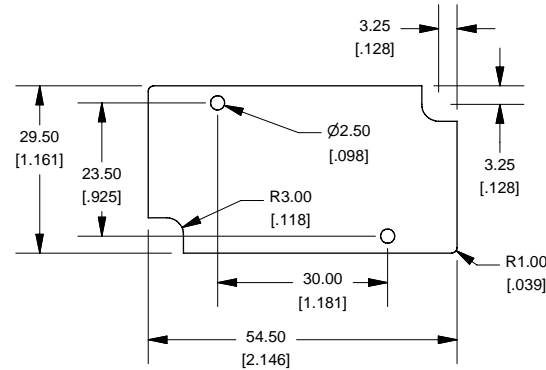

NOTE

Purchased assembly includes lid and box made from GP ABS material and cover screws.

1551J	
1551J Enclosure	
Black Enclosure - RAL 9011 - UL94 - HB	1551JBK
Gray Enclosure - RAL 7035 - UL94 - HB	1551JGY
Translucent Blue - UL94 - HB	1551JTBU
ACCESSORIES	
Recommended Screw Torque: 15-20 ozf.in (10-15 cN.m)	
Black Enclosure Cover Screws (Pkg 100) X 1/2" Self Tapping	#4 1591TS100BK
Grey Enclosure Cover Screws (Pkg 100) X 1/2" Self Tapping	#4 1591TS100
P.C. Board Screws (Pkg 100) #2 x 3/16" Self Tapping	1551ATS100

