



SEMiX® 1s

Rectifier Diode Module

SEMiX 191KD

Preliminary Data

Features

- Terminal height 17 mm
- Chips soldered directly to isolated substrate

Typical Applications

- Input Bridge Rectifier for
- AC/DC motor control
- power supply

V_{RSM} V	V_{RRM} V	$I_{FRMS} = 285$ A (maximum value for continuous operation)	
1700	1600	$I_{FAV} = 190$ A (sin. 180; $T_c = 85$ °C)	
		SEMiX 191KD16s	

Symbol	Conditions	Values	Units
I_{FAV}	sin. 180; $T_c = 85$ (100) °C	190 (145)	A
I_{FSM}	$T_{vj} = 25$ °C; 10 ms	6000	A
	$T_{vj} = 130$ °C; 10 ms	5000	A
i^2t	$T_{vj} = 25$ °C; 8,3 ... 10 ms	180000	A ² s
	$T_{vj} = 130$ °C; 8,3 ... 10 ms	125000	A ² s
V_F	$T_{vj} = 25$ °C; $I_F = 500$ A	max. 1,5	V
$V_{(TO)}$	$T_{vj} = 130$ °C	max. 0,85	V
r_T	$T_{vj} = 130$ °C	max. 0,95	mΩ
I_{RD}	$T_{vj} = 130$ °C; $V_{RD} = V_{RRM}$	max. 12	mA
$R_{th(j-c)}$	per diode	0,18	K/W
$R_{th(c-s)}$	per module	0,075	K/W
T_{vj}		- 40 ... + 130	°C
T_{stg}		- 40 ... + 125	°C
V_{isol}	AC, 50Hz.; rms; 1s/1min	4800 / 4000	V~
M_s	(min./max.)	3/5	Nm
M_t	(min./max.)	2,5/5	Nm
a		5 * 9,81	m/s ²
m	approx.	145	g
Case	SEMiX 1s		



KD

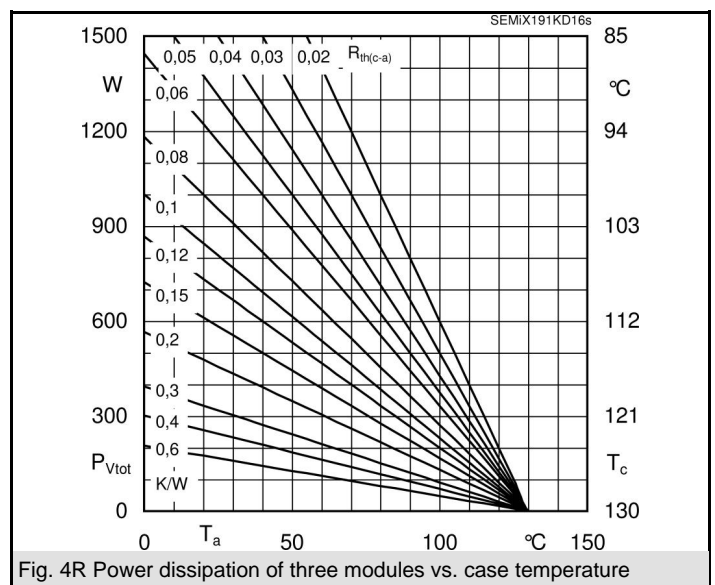
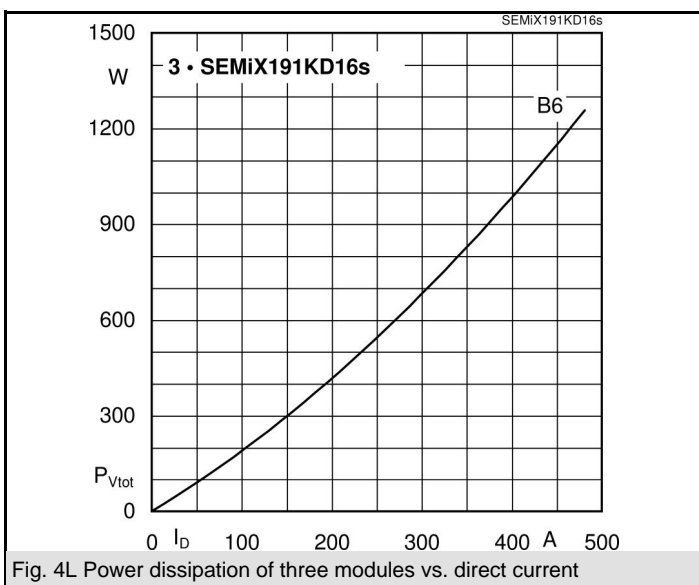
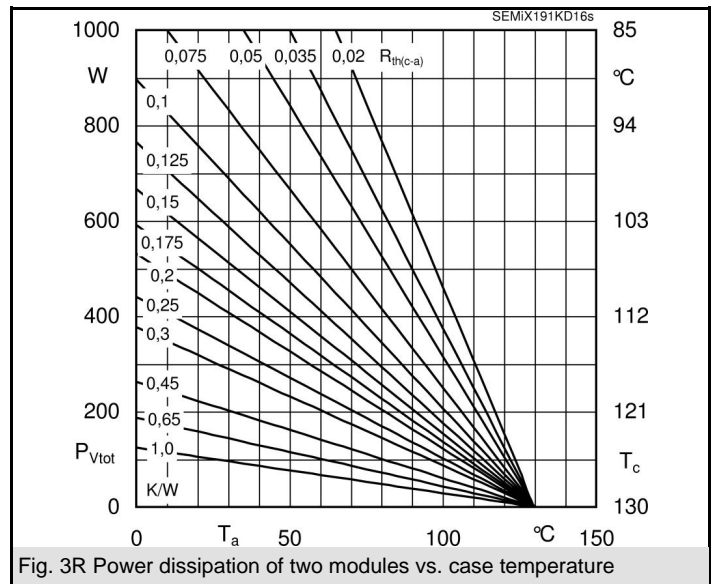
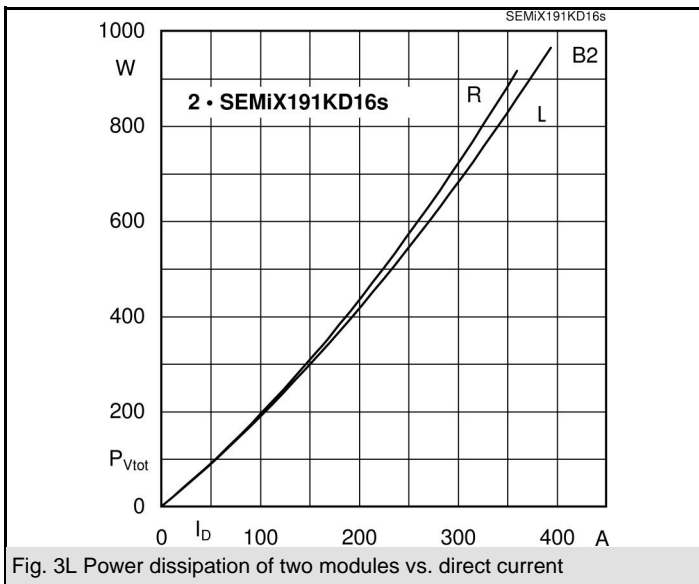
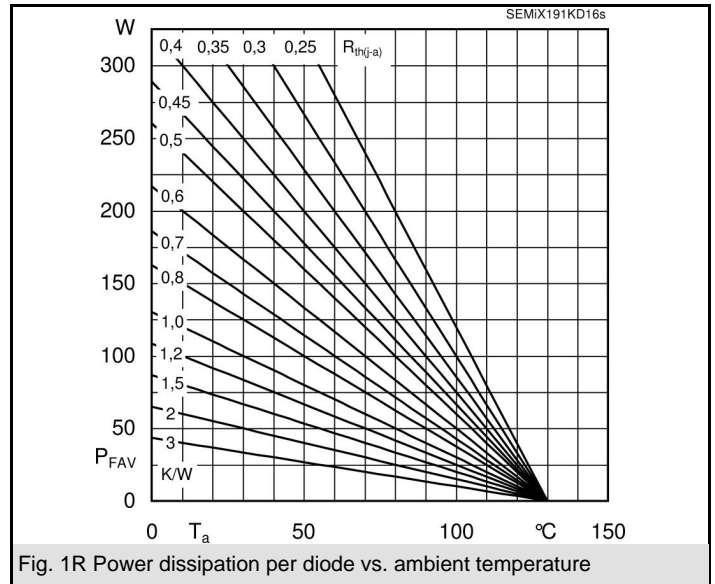
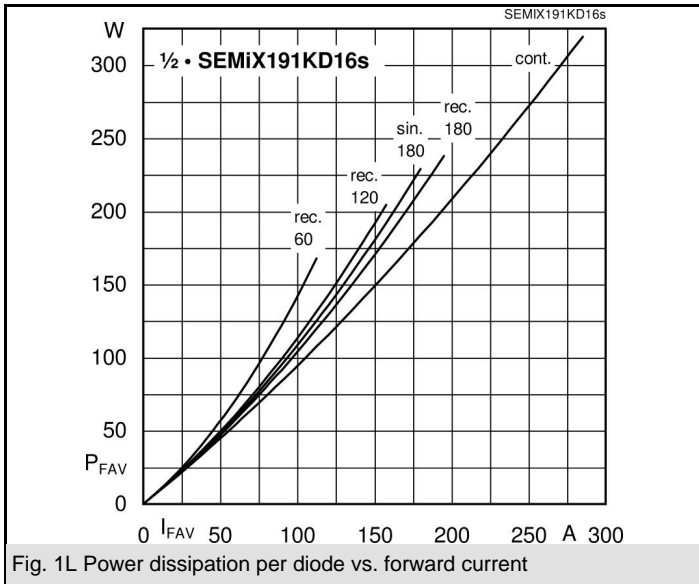

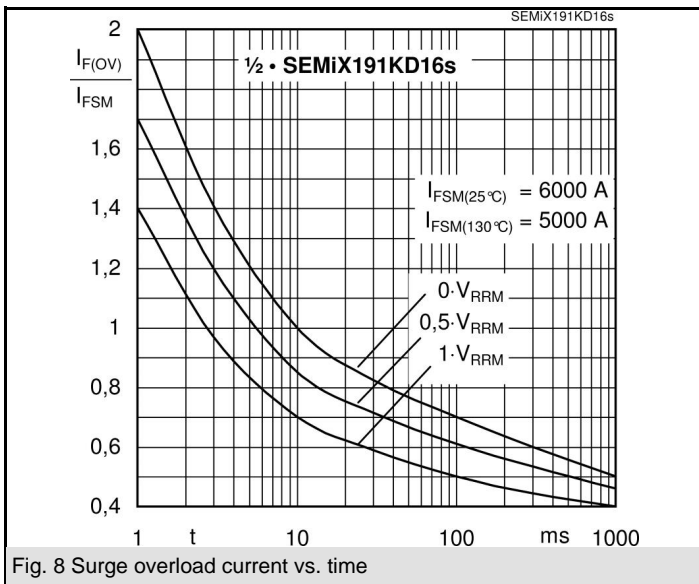
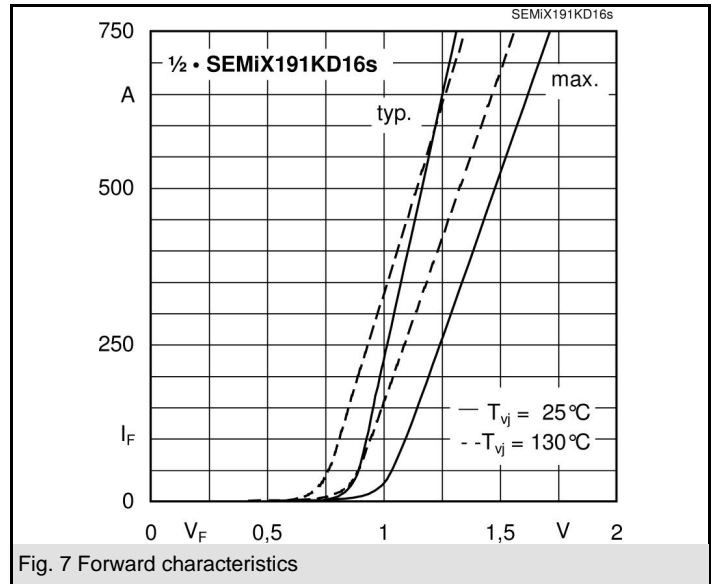
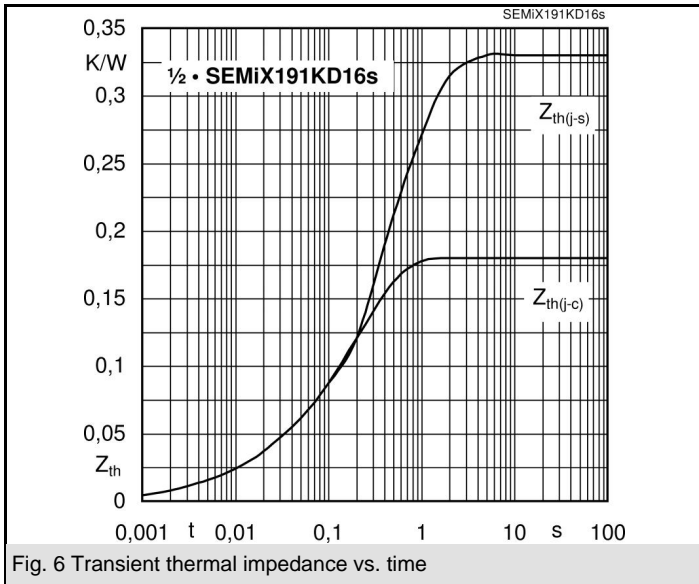

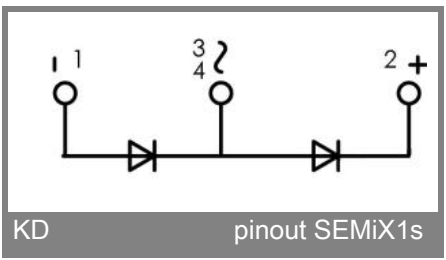
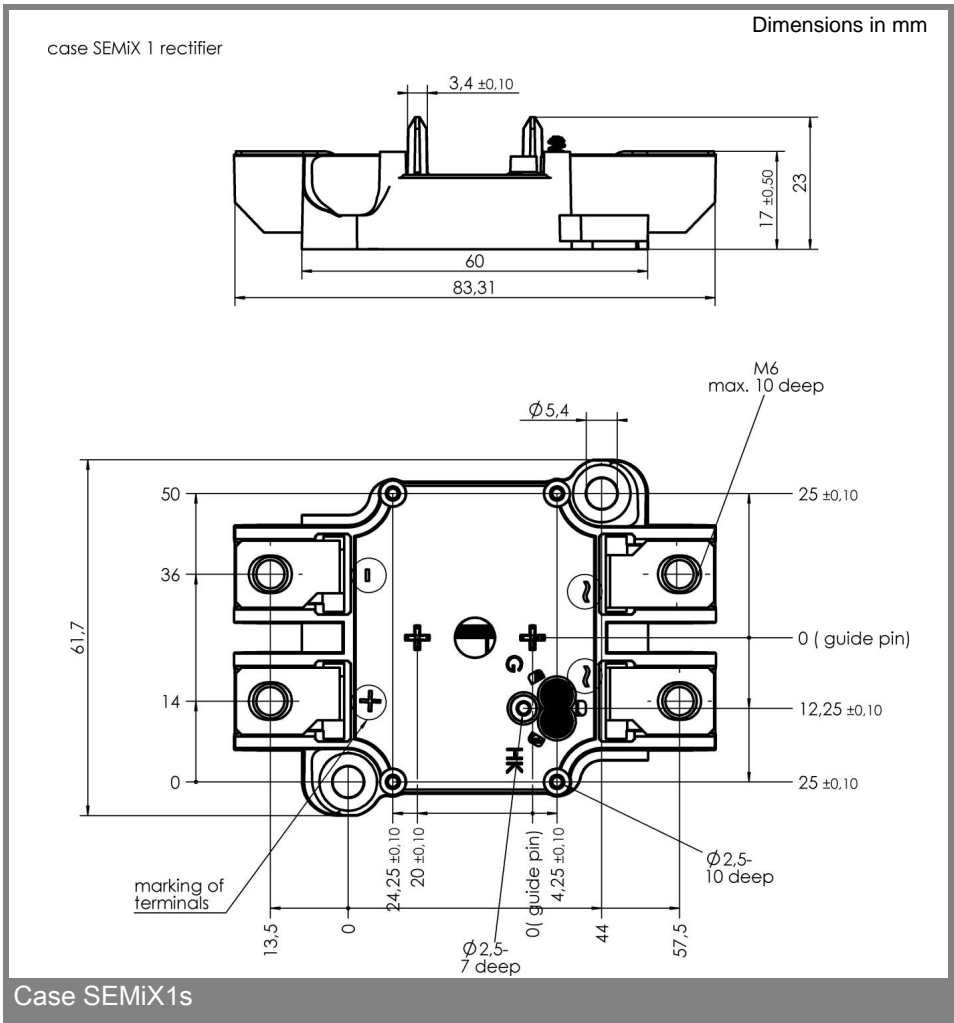

This technical information specifies semiconductor devices but promises no characteristics. No warranty or guarantee expressed or implied is made regarding delivery, performance or suitability.