

Line switch with/without bowden cable, fuseh. 5x20/6.3x32 mm, voltage selector

Standard- or Medical-Filter



Fuse drawer must be ordered separately (see accessories).

C14



70° C



Description

- Panel Mount:
Screw-on from front side
- 5 Functions:
Appliance Inlet, Line switch, Fuseholder with interchangeable fuse drawer for Fuse-links 5 x 20 mm or 6.3 x 32 mm, with or without voltage selector (step switch), Line filter in standard and medical version
- Quick connect terminals 4.8 x 0.8 mm
- Alternative: version without line filter [KD](#)

Approvals

- VDE License Number: 40004665 (FKSO, FKSP, FKSU, FKSV)
- UL License Number: E72928 (FKSO, FKSP, FKSU, FKSV)

Characteristics

- All single elements are already wired
- The fuse drawer "Fingergrip" can be removed by hand
For added safety "Extra-Safe" fuse drawers are available
Fuse drawer meets requirements of medical standard IEC/EN 60601-1
The fuse drawer can only be opened with the aid of a tool
The fuseholder is accessible from the equipment front
- Qualified for use in equipment according IEC/EN 60950

References

[General Product Information](#)

Weblinks

[Approvals](#), [RoHS](#), [CHINA-RoHS](#), [e-Store](#), [SCHURTER-Stock-Check](#), [Distributor-Stock-Check](#)

Technical Data

Ratings IEC	1 - 10A @ Ta 40 °C / 250VAC; 50Hz	Appliance-Inlet/-Outlet	C14 acc. to IEC/EN 60320-1, UL 498, CSA C22.2 no. 42 (for cold conditions) pin-temperature 70 °C, 10A, Protection class I
Ratings UL/CSA	1 - 10A @ Ta 40 °C / 125VAC; 60Hz	Fuseholder	1 or 2 pole, Shocksafe category PC2 acc. to IEC 60127-6, for fuse-links 5 x 20 or 6.3 x 32 mm
Leakage Current	standard < 0.5 mA (250 V / 60Hz) medical < 5 µA (250 V / 60 Hz)	Rated Power Acceptance @ Ta 23 °C	5 x 20: 2.5W (1 pole)/ 2W (2-pole) per pole 6.3 x 32: 3.15W (1 pole)/ 2.5W (2-pole) per pole
Dielectric Strength	> 1.7 kVDC between L-N > 2.7 kVDC between L/N-PE Test voltage (2 sec)	Power Acceptance @ Ta > 23°C	Admissible power acceptance at higher ambient temperature see derating curves
Allowable Operation Temp.	-25 °C to 85 °C	Line Switch	Rocker switch 2-pole, non-illuminated, acc. to IEC 61058-1 Technical details
Climatic Category	25/085/21 acc. to IEC 60068-1	Voltage selector	optional, step, 2-4 digits
Degree of Protection	from front side IP 40 acc. to IEC 60529	Line Filter	Standard and Medical Version, IEC 60939, IEC 60601-1, UL 1283, UL 544, EN 133 200, CSA C22.2 no. 8 Technical details
Protection Class	Suitable for appliances with protection class I acc. to IEC 61140	MTBF	> 1'200'000h acc. to MIL-HB-217 F
Terminal	Quick connect terminals 4.8 x 0.8 mm		
Panel Thickness s	Screw-on: max 8mm Mounting screw torque max 0.5Nm		
Material: Housing	Thermoplastic, black, UL 94V-0		

Dimensions

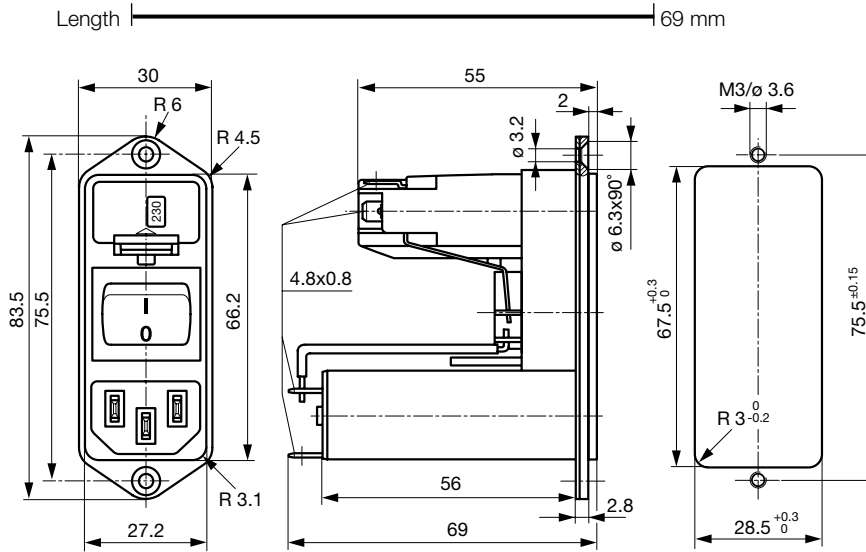

Technical Data of Filter-Components

Rated Current [A]	Filter-Type	Inductances L [mH]	Capacitance CX [nF]	Capacitance CY [nF]	R [MΩ]
1	Standard Version	2 x 10	68	2.2	-
2	Standard Version	2 x 4	68	2.2	-
4	Standard Version	2 x 1.5	68	2.2	-
6	Standard Version	2 x 0.8	68	2.2	-
10	Standard Version	2 x 0.3	68	2.2	-
1	Medical Version (M5)	2 x 10	68	-	1
2	Medical Version (M5)	2 x 4	68	-	1
4	Medical Version (M5)	2 x 1.5	68	-	1
6	Medical Version (M5)	2 x 0.8	68	-	1
10	Medical Version (M5)	2 x 0.3	68	-	1

Diagrams

Standard version with voltage selector

Medical version with voltage selector

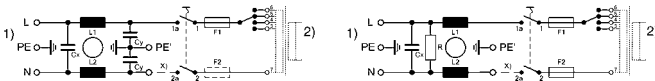

- 1) Line
- 2) Load
- x) External connection to be made by the customer

Derating Curves

Fuses 5 x 20 mm (1-pole)

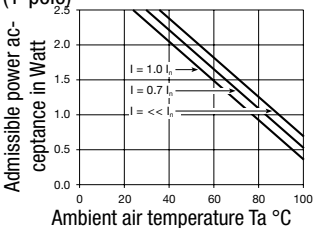

Fuses 5 x 20 mm (2-pole, per pole)

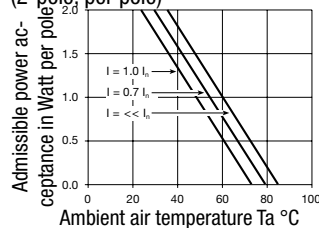

Fuses 6,3 x 32 mm (1-pole)

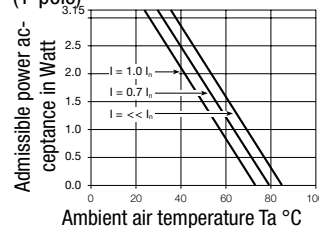

Fuses 6,3 x 32 mm (2-pole, per pole)

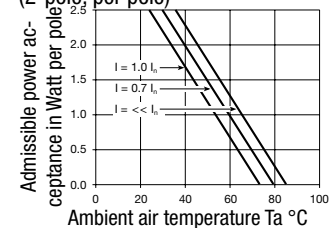

Attenuation Loss

--- differential mode ____ common mode

Standard version

1 A

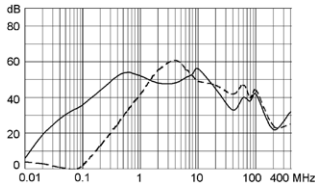

2 A

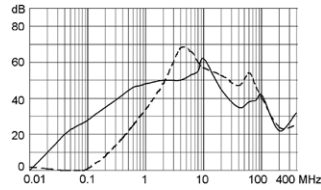

4 A

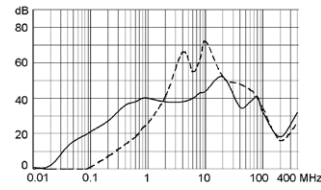

6 A

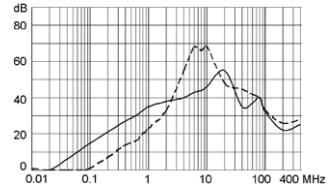

10 A

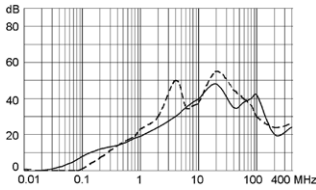

Medical version (M5)

1 A

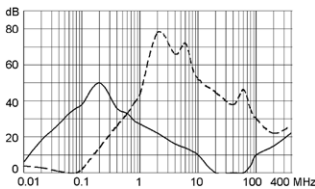

2 A

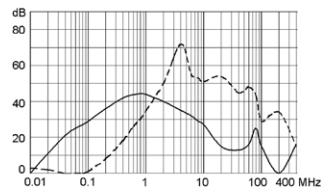

4 A

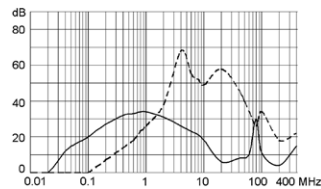

6 A

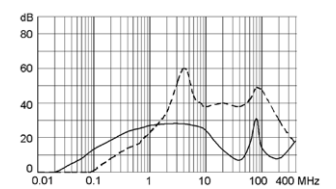

10 A

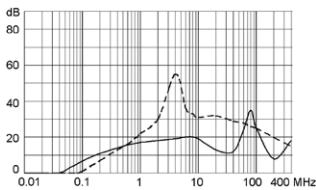

Variants

Type	Rated Current [A]	Filter-Type	Fuseholder	Line Switch	Voltage selector	Order Number
CD	1	Standard Version	1 pole	2-pole	-	CD11.1501.151
CD	2	Standard Version	1 pole	2-pole	-	CD21.1501.151
CD	4	Standard Version	1 pole	2-pole	-	CD31.1501.151
CD	6	Standard Version	1 pole	2-pole	-	CD41.1501.151
CD	10	Standard Version	1 pole	2-pole	-	CD61.1501.151
CD	1	Standard Version	1 pole	2-pole	2-4 digits	CD11.4501.151
CD	2	Standard Version	1 pole	2-pole	2-4 digits	CD21.4501.151
CD	4	Standard Version	1 pole	2-pole	2-4 digits	CD31.4501.151
CD	6	Standard Version	1 pole	2-pole	2-4 digits	CD41.4501.151
CD	10	Standard Version	1 pole	2-pole	2-4 digits	CD61.4501.151
CD	1	Standard Version	2-pole	2-pole	-	CD14.1101.151
CD	2	Standard Version	2-pole	2-pole	-	CD24.1101.151
CD	4	Standard Version	2-pole	2-pole	-	CD34.1101.151
CD	6	Standard Version	2-pole	2-pole	-	CD44.1101.151
CD	10	Standard Version	2-pole	2-pole	-	CD64.1101.151
CD	1	Standard Version	2-pole	2-pole	2-4 digits	CD14.4101.151
CD	2	Standard Version	2-pole	2-pole	2-4 digits	CD24.4101.151

Type	Rated Current [A]	Filter-Type	Fuseholder	Line Switch	Voltage selector	Order Number
CD	4	Standard Version	2-pole	2-pole	2-4 digits	CD34.4101.151
CD	6	Standard Version	2-pole	2-pole	2-4 digits	CD44.4101.151
CD	10	Standard Version	2-pole	2-pole	2-4 digits	CD64.4101.151
CD	1	Medical Version (M5)	2-pole	2-pole	2-4 digits	CDG4.4101.151
CD	2	Medical Version (M5)	2-pole	2-pole	2-4 digits	CDA4.4101.151
CD	4	Medical Version (M5)	2-pole	2-pole	2-4 digits	CDC4.4101.151
CD	6	Medical Version (M5)	2-pole	2-pole	2-4 digits	CDE4.4101.151
CD	10	Medical Version (M5)	2-pole	2-pole	2-4 digits	CDL4.4101.151

Packaging unit 10 Pcs

Required Accessory

Description

Fusedrawer 3

Drawers for fuse links 5x20mm resp. 6.3x32mm



Fingergrip, 5 x 20, 2-pole, Voltage selector	4303.2014.00
Fingergrip, 5 x 20, 2-pole, Voltage selector, 100, 120, 220, 240	4303.2014.01
Fingergrip, 5 x 20, 2-pole, Voltage selector, 110, 150, 220	4303.2014.02
Fingergrip, 5 x 20, 2-pole, Voltage selector, 110, 220	4303.2014.03

...

Accessory



Assorted Covers

Rear Cover

0859.0077



Cord retaining kits

Cord retaining strain relieve

Flat head, A

4700.0001

Passende Dose

Category / Description

Appliance Outlet



IEC appliance outlet F, screw-on mounting, front side, solder /quick connect terminal	4787
IEC appliance outlet F, screw-on mounting, front side, solder /quick connect terminal	4788
IEC appliance outlet F oder H, screw-on mounting, front side, solder/PCB/quick connect terminal	5091
IEC appliance outlet F oder H, screw-on mounting, front side, solder/quick connect terminal	5092