

FUSEHOLDERS

PCB mount

FAU

for 5×20 / $6,3 \times 32$ mm

Fuseholder Type FAU

horizontal
shocksafe category PC2

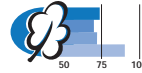

- bayonet type fuse carrier, slotted
- with or without "kicked" PCB-terminals
- non-conductive center post adds stability
- degree of protection IP 40 from front side, according to IEC 60529
- suitable for equipment with protection classes I and II according to IEC 60536

Technical data

- Rated voltage: 250 V
- Rated current: 10 A
- Rated power acceptance at ambient air temperature T_a 23 °C for fuse links
5 x 20: 2,5 W/6,3 x 32: 3,2 W
- Power acceptance at higher T_a : see derating curves
Take note of the information on pages 215–219
- Allowable ambient air temperatures T_a for accessible parts:
–40 °C to +85 °C
- Contact resistance: 5 m Ω
- Dielectric strength: > 4 kV, 50 Hz, 1 min.*
- Insulation resistance (500 V DC/1 Min): > 103 M Ω
- Solderability: 235 °C/2 s, according to IEC 60068-2-20, test Ta, method 1
- Resistance to soldering heat: 350 °C/5 s, according to IEC 60068-2-20, test Tb, method 1B
- Materials
socket: thermoplastic, UL 94 V-0
fuse carrier: thermoplastic, UL 94 V-0

* between metal mounting plate and live parts

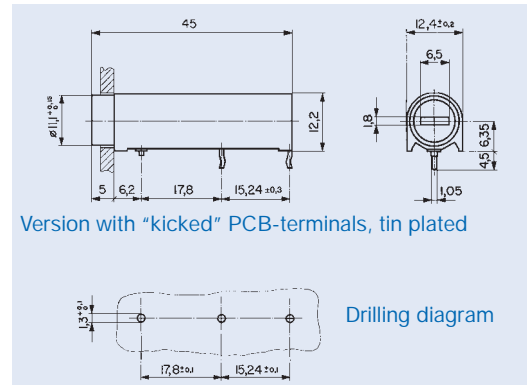

Derating curve

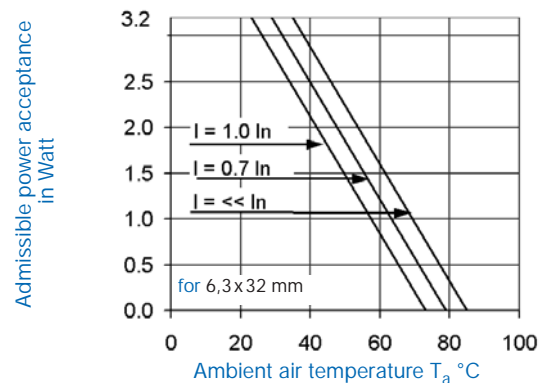
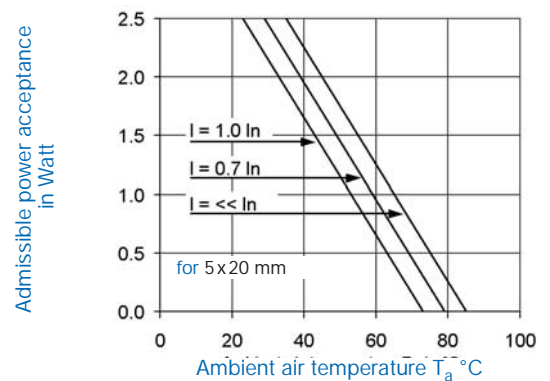

Approvals, Patents

SEV (6,3 A/250 V)	UL (16 A/250 V)
VDE (10 A/250 V)	CSA (16 A/250 V)
SEMKO (6,3 A/250 V)	

Standards

IEC 60127-6
EN 60127-6
UL 512, CSA C22.2-39

Patents in U.S. (No. 4,072,385) and in further countries

Order No.	Socket and fuse carrier must be ordered separately	suitable for fuse-links
0031.3573	Socket, black, with straight terminals	5 x 20 and 6,3 x 32 mm
0031.3577	Socket, black, with "kicked" terminals	5 x 20 and 6,3 x 32 mm

Order Numbers with fuse carrier (example: FAU 0031.3581 = fuseholder FEU 0031.3577 and fuse carrier FEK 0031.1666 packaged together)

Fuse carrier	FEK 0031.1666 bayonet/grey for 6,3 x 32 mm fuse-links	FEK 0031.1666 bayonet/black for 5 x 20 mm fuse-links	FEK 0031.1667 fingergrasp/black for 6,3 x 32 mm fuse-links	FEK 0031.1741 fingergrasp/black for 5 x 20 mm fuse-links
FAU 0031.3577	FAU 0031.3581	FAU 0031.3571	FAU 0031.3583	n/a

Accessories see page 183