

See "Part Drawing" for Details

Part Number	Description
WIT-RT-2150-Q	Cbl Tie,Release,Nat,21.5" Lg,250Lb 

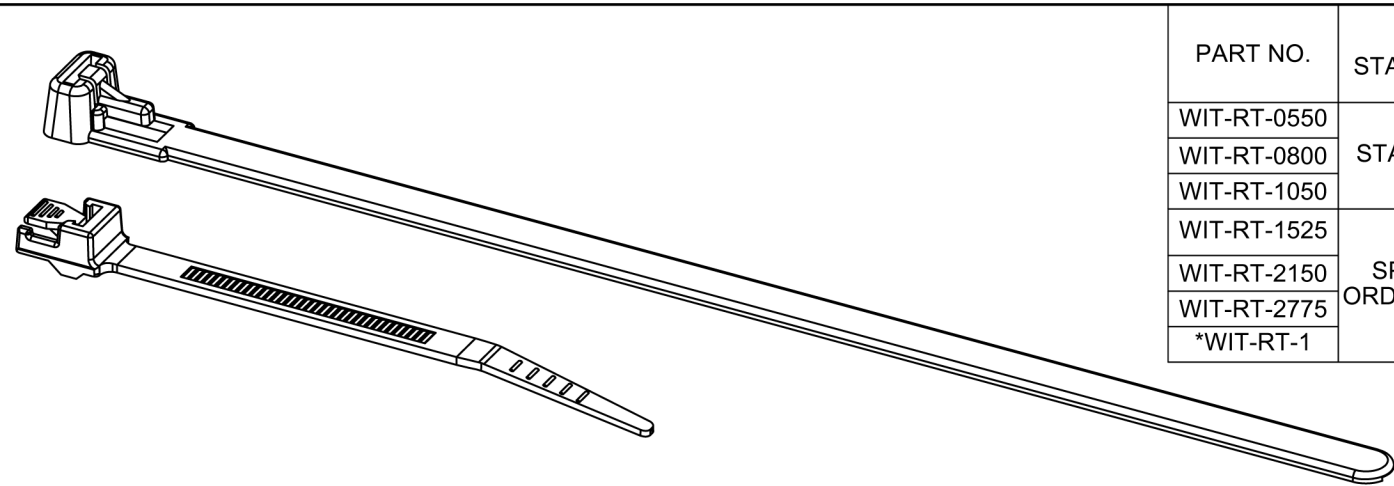

PART NO.	UVB STABILIZED	BUNDLE DIA. MIN	BUNDLE DIA. MAX	"L" LENGTH APPROX	"W" WIDTH REF	"T" THICKNESS REF	"A"	"B"	"C"	MIN LOOP TENSILE	FIGURE NO.
WIT-RT-0550	STANDARD	3/16 [4.8]	1-1/4 [31.8]	5-1/2 [139.7]	.21 [5.3]	.05 [1.3]	.24 [6.1]	.36 [9.1]	.45 [11.4]	40 lbf (18 kgf)	1
WIT-RT-0800			2 [50.8]	8 [203.2]							
WIT-RT-1050			2-1/2 [63.5]	10-1/2 [266.7]							
WIT-RT-1525	SPECIAL ORDER ONLY	2 [50.8]	4 [101.6]	15-1/4 [387.4]	.52 [13.2]	.09 [2.3]	.38 [9.7]	.80 [20.3]	.86 [21.8]	250 lbf (113 kgf)	
WIT-RT-2150			6 [152.4]	21-1/2 [246.1]							
WIT-RT-2775			8 [203.2]	27-3/4 [704.9]							
*WIT-RT-1			1/4 [6.4]	1-7/8 [48]							8-3/32 [206]

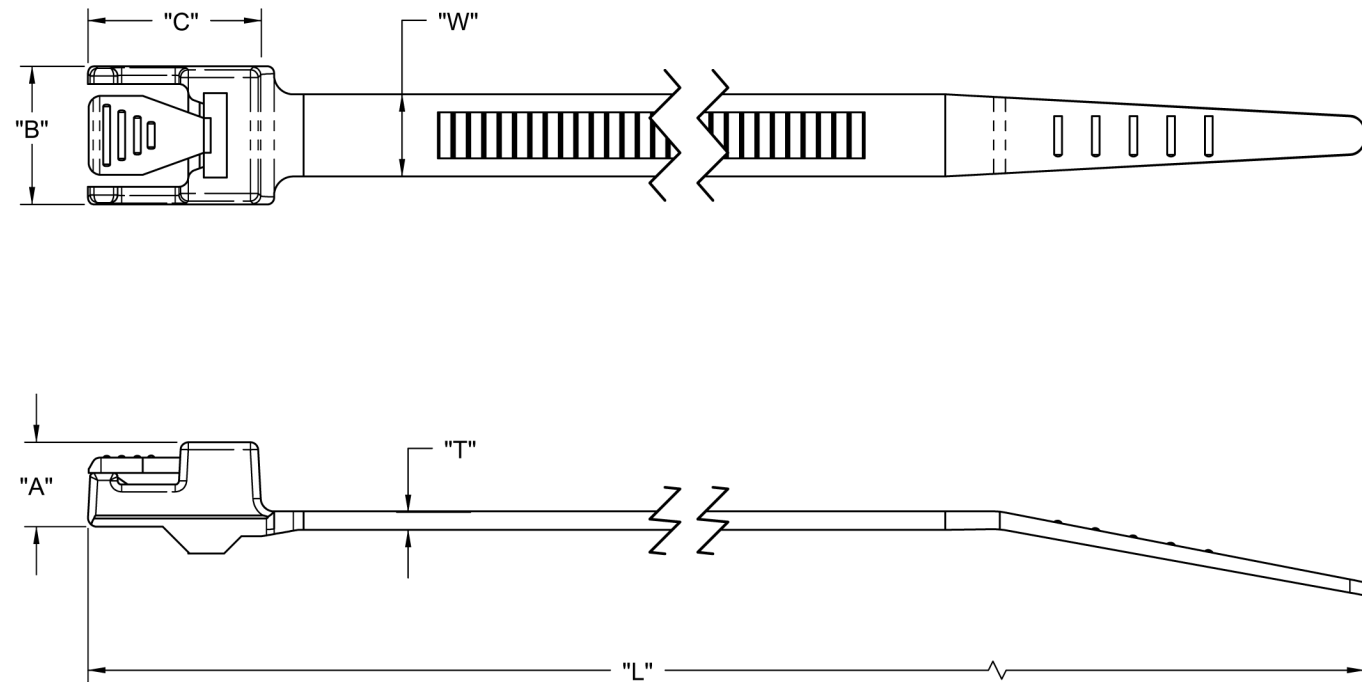

FIG 1.

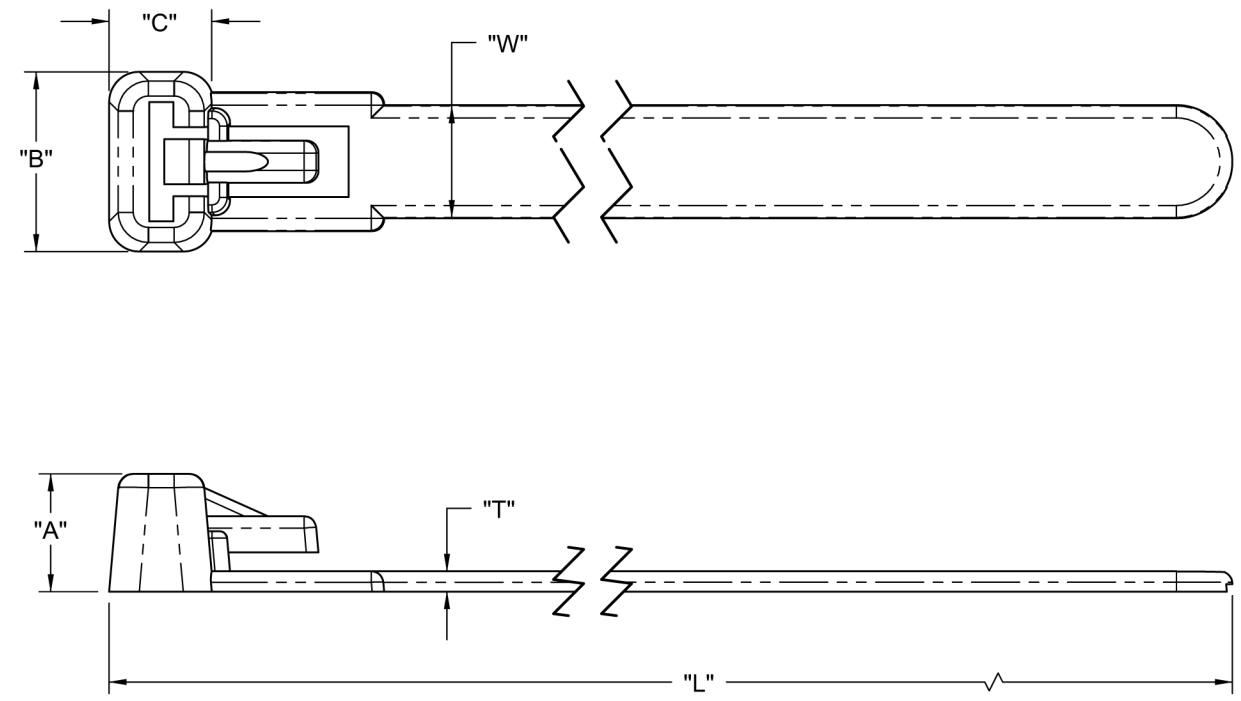

FIG 2.

NOTES:

1. MATERIAL: NYLON 6/6 UL 94 V-2 (RMS-01). COLOR NATURAL.
*COLOR BLACK, BY SPECIAL ORDER ONLY(-BK).

UV STABILIZED NYLON 6/6 (RMS-46), COLOR BLACK.
TO ORDER USE P/N: WIT-RT-XXXX-UVB

2. COLORS: GREEN (-GN), BLUE (-BL), YELLOW (-YL) AND RED (-RD)
AVAILABLE BY SPECIAL ORDER ONLY.
TO ORDER ADD COLOR SUFFIX TO PART NO.

REV.	DESCRIPTION	ENGR.	DATE
A	REDRAWN, SEE CO 200081 FOR CHANGES	SK	12/05/07

TITLE: RELEASE TAB WRAP IT TIES				DWG IN IN [MM]		FINAL	
CREATED USING SOLIDWORKS	FILE #: WIT-RT	DWN: SK	APP: D.Z.	PART #			
TOLERANCES UNLESS NOTED .XX=±.010 .XXX=±.005 FRAC.=±1/64 ANG.=±1°	SHEET: 1 OF 1	SHEET SIZE: B	DT: 12/04/07	CHKD: S.J.	SEE TABLE		PRINT TYPE
RE: RICHCO, INC.		RICHCO, INC.				CA	