

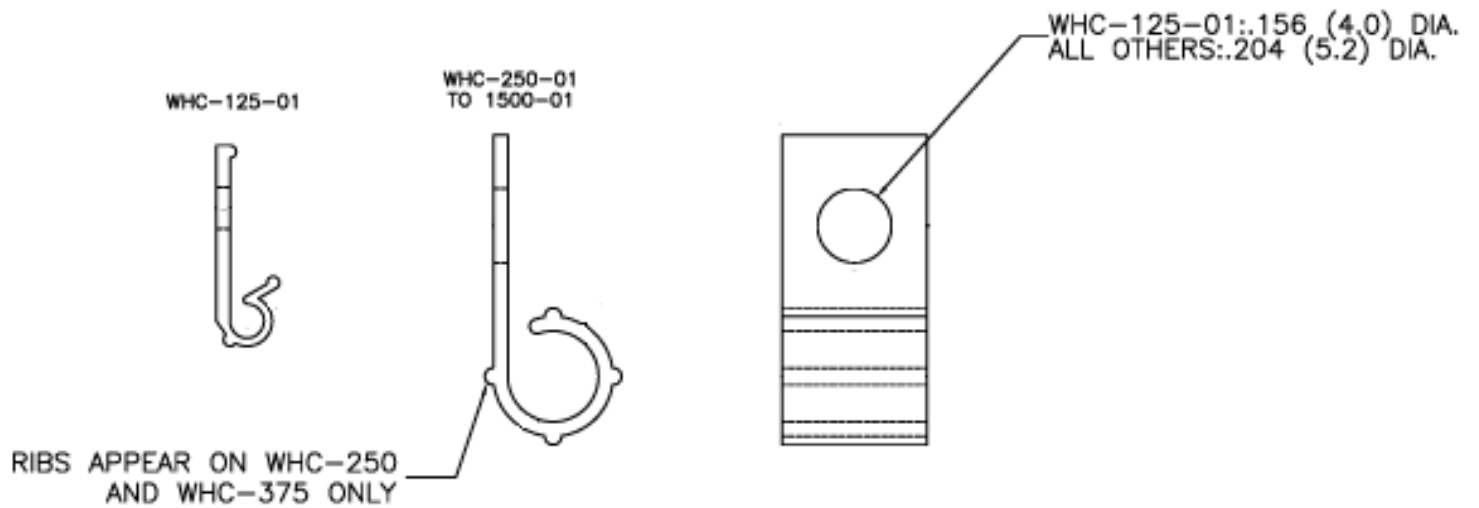

See "Part Drawing" for Details



Part Number	Description
WHC-500-01	Clip,Screw Mnt,Natural,1/2" Hold 

NYLON 6/6 (RMS-01) COLOR: NATURAL PART NO.	"A" (HOLDING DIAMETER)	"B"	"C"	"D"	"E" REF.
WHC-125-01	1/8 (3.2)	.05 (1.3)	.33 (8.4)	.23 (5.8)	.75 (19.1)
WHC-250-01	1/4 (6.4)	.04 (1.0)	.40 (10.2)	.25 (6.4)	.83 (21.1)
WHC-375-01	3/8 (9.5)	.05 (1.3)		.19 (4.8)	
WHC-500-01	1/2 (12.7)	.07 (1.8)	.50 (12.7)	.25 (6.4)	1-5/32 (29.4)
WHC-625-01	5/8 (15.9)	.08 (2.0)		.19 (4.8)	1-1/8 (28.6)
WHC-750-01	3/4 (19.1)	.09 (2.2)		.19 (4.8)	1-9/32 (32.5)
WHC-1000-01	1 (25.4)	.09 (2.2)		.19 (4.8)	1-17/32 (38.9)
WHC-1500-01	1-1/2 (38.1)	.10 (2.5)		.10 (2.5)	2-1/8 (53.9)

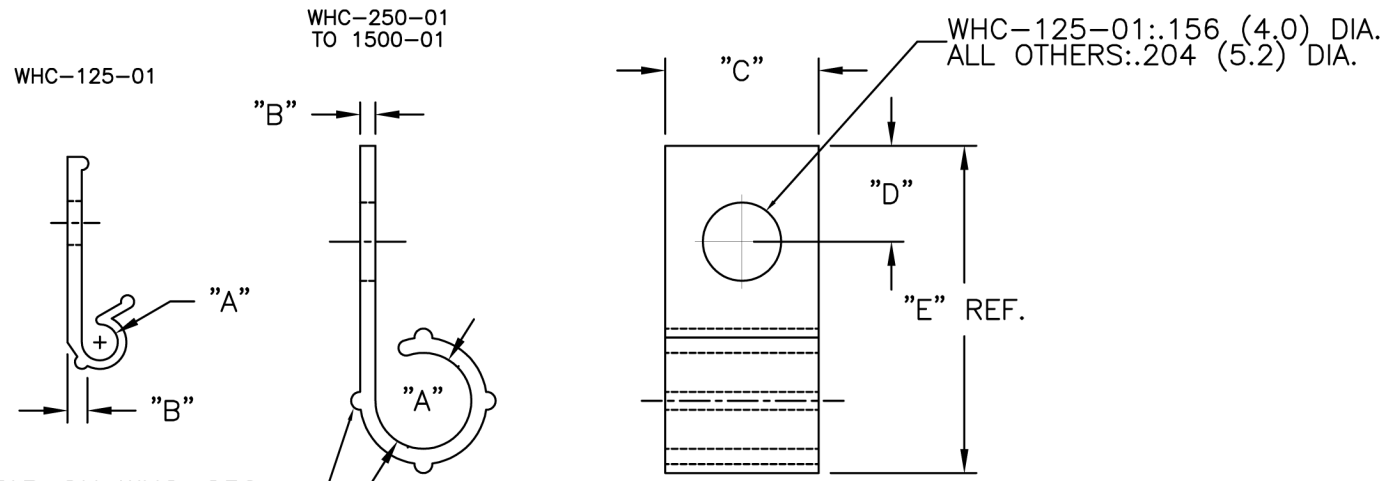

RIBS APPEAR ON WHC-250
AND WHC-375 ONLY

NOTES:

1. MATERIAL: FLAME RETARDANT (RMS-19),
COLOR NATURAL,
AVAILABLE BY SPECIAL ORDER.
TO ORDER, REPLACE "-01" WITH "-19".
2. MATERIAL: UV STABILIZED NYLON (RMS-46),
COLOR BLACK, AVAILABLE BY SPECIAL ORDER.
TO ORDER, REPLACE "-01" WITH "-UVB"

TITLE: WIRE HARNESS CLIP		DWG IN IN (MM)		FINAL	
TOLERANCES UNLESS NOTED .XX=±.010 .XXX=±.005 FRAC=1/64 ANG=1°	FILE # WHC	DWN: P.B.	APP:	PART #	
	MAT'L: SEE TABLE	DT: 05-02-94	DT:	SEE TABLE	
	RE: RICHCO, INC.	RICHCO INC.		PRINT TYPE CA	

REV	DESCRIPTION	ENGR	DATE
G	SEE CO 200091 FOR CHANGES	SK	12.18.07
F	SEE ECN #1358 FOR CHANGES	SK	08.24.07
-	SEE ENGINEERING FOR REV A-E		