

See "Part Drawing" for Details

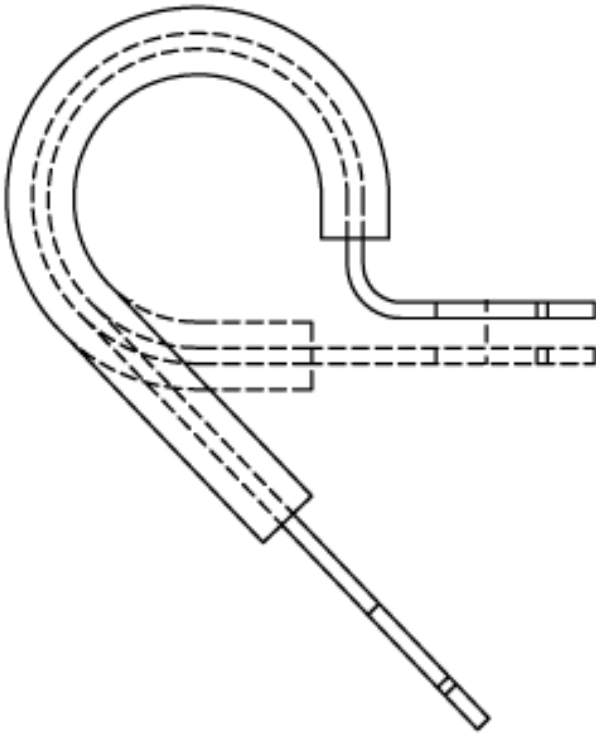
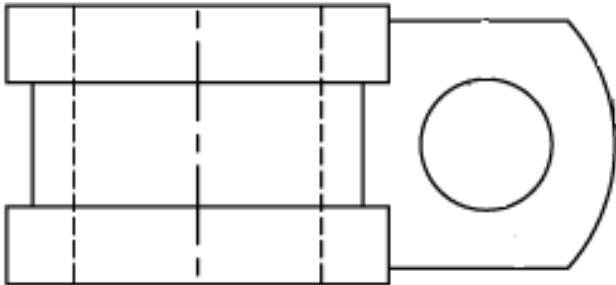

Part Number	Description
-------------	-------------

[SPN-7](#)

Clamp,Rbbr Cov Steel,Blk,7/16"Hold



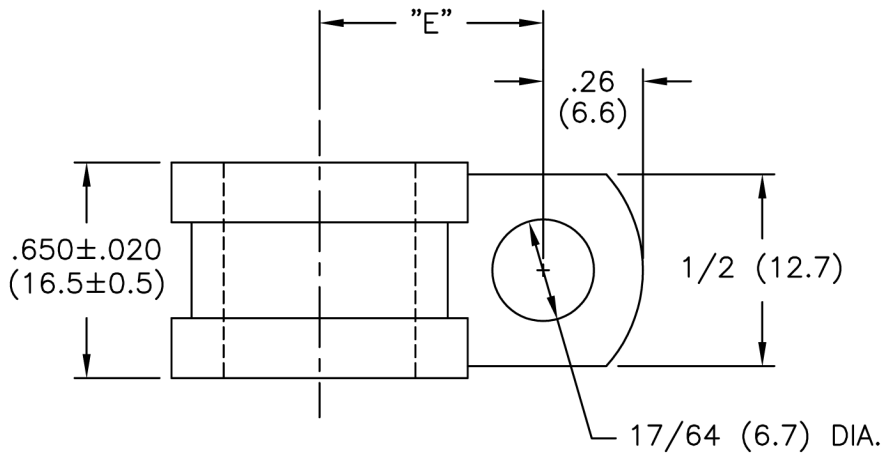

PART NO.	HOLDING DIA "D"	"E" REF.
SPN-3	3/16 (4.8)	.50 (12.7)
SPN-4	1/4 (6.4)	.53 (13.5)
SPN-5	5/16 (7.9)	.56 (14.2)
SPN-6	3/8 (9.5)	.59 (15.0)
SPN-7	7/16 (11.1)	.62 (15.7)
SPN-8	1/2 (12.7)	.65 (16.5)
SPN-9	9/16 (14.3)	.75 (19.1)
SPN-10	5/8 (15.9)	.78 (19.8)
SPN-11	11/16 (17.5)	.81 (20.6)
SPN-12	3/4 (19.1)	.84 (21.3)
SPN-14	7/8 (22.2)	.90 (22.9)
SPN-16	1.0 (25.4)	.96 (24.4)
SPN-18	1-1/8 (28.6)	1.05 (26.7)
SPN-20	1-1/4 (31.8)	1.11 (28.2)

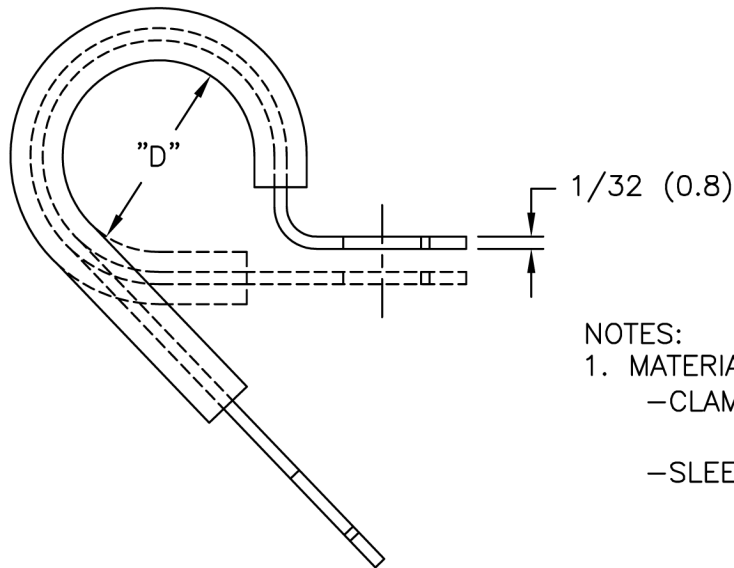

NOTES:

1. MATERIALS:

- CLAMP: ZINC ELECTROPLATE (RMS-339).
COLD ROLLED STEEL (RMS-198).
- SLEEVE: SANTOPRENE (RMS-67)
(MEETS MILS R-3065 & AMS-3209 SPECIFICATIONS)

E SEE ECN #1254 FOR CHANGES SK 11.29.06		TITLE: STEEL, SANTOPRENE SLEEVE CLAMP		DWG IN IN (MM)	
D SEE ECN #972 FOR CHANGES SK 04.05.05		FILE # SPN		DWN: P.B. APP:	
C ADDED MILS & AMS NOTE SJ 03.05.02		TOLERANCES UNLESS NOTED .XX=±.010 .XXX=±.005 FRAC=±1/64 ANG=±1°		FINAL	
B REMOVED VIEW SANTOPRENE CUSHION; CHANGED TITLE BLOCK AND FILE NO. SM 03.26.01		MAT'L: SEE NOTES		PART #	
A CHANGED MAT'L TO SANTOPRENE JB 02.14.96		RE: RICHCO, INC.		SEE TABLE	
REV DESCRIPTION ENGR DATE		DT: 10-17-94 DT: RICHCO INC.		PRINT TYPE CA	