

See "Part Drawing" for Details



Part Number	Description
-------------	-------------

[N-8](#)

Clamp, Screw Mnt, Natural, 1/2" Hold



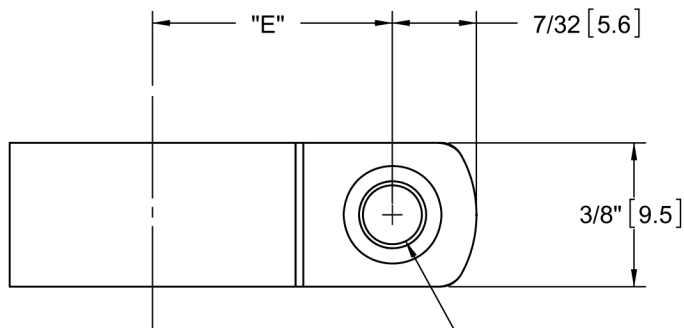

11/64 [4.4] DIA.
 (1/8 [3.2] FOR N1 ONLY)
 SOME PARTS MAY HAVE
 SLIGHT CHAMFER ON HOLE

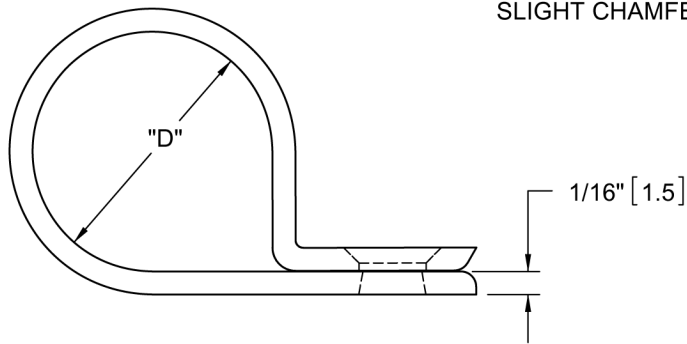

PART NO.		"D" HOLDING DIA.	"E" REF.
RMS-01 NATURAL	RMS-01 BLACK		
N-1	N-1-BK	1/16 [1.6]	.27 [6.7]
N-2	N-2-BK	1/8 [3.2]	21/64 [8.3]
N-3	N-3-BK	3/16 [4.8]	25/64 [9.9]
N-4	N-4-BK	1/4 [6.4]	27/64 [10.7]
N-5	N-5-BK	5/16 [7.9]	29/64 [11.5]
N-6	N-6-BK	3/8 [9.5]	31/64 [12.3]
N-7	N-7-BK	7/16 [11.1]	17/32 [13.5]
N-8	N-8-BK	1/2 [12.7]	9/16 [14.3]

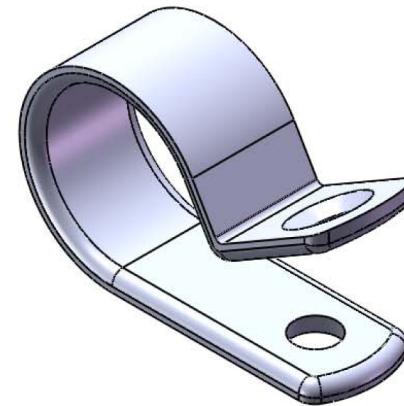

SHOWN AS MOLDED

NOTES:

1. MATERIAL: NYLON 6/6 UL 94 V-0 (RMS-19).COLOR NATURAL, AVAILABLE BY SPECIAL ORDER ONLY. TO ORDER ADD "-19" TO THE END OF PART NUMBER.
2. MATERIAL: NYLON 6/6 UL 94 V-2, UV STABILIZED (RMS-46), COLOR BLACK, AVAILABLE BY SPECIAL ORDER ONLY. TO ORDER REPLACE "-BK" WITH "-UVB"
3. RECOMMENDED SCREW SIZE IS #8 [M4], (#4 [M2.5] FOR N-1).

G			SEE CO 200152 FOR CHANGES	SK	04/03/08	TITLE: CABLE CLAMP, N SERIES					DWG IN IN [MM]	
-			SEE ENGINEERING FOR REV A-F	-	-----	CREATED USING SOLIDWORKS	FILE #: N-SERIES	DWN: S.K.	APP: R.G.	FINAL		
REV.			DESCRIPTION	ENGR.	DATE	TOLERANCES UNLESS NOTED .XX=±.010 .XXX=±.005 FRAC.=±1/64 ANG.=±1°	SHEET: 1 OF 1	SHEET SIZE: A	DT: 04/01/08	CHKD: S.J.	PART #	PRINT TYPE
						RE: RICHCO, INC.	RICHCO, INC.		SEE TABLE		CA	