

Part Number

[KKL-8-RT](#)

Description

Clip,Locking,Adh Mnt,Grey,1/2" Hold



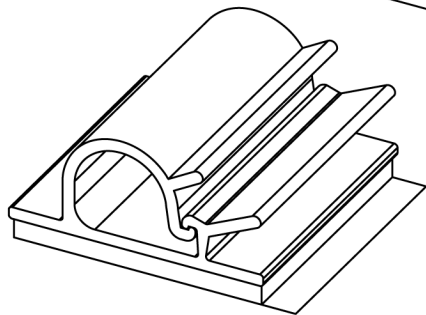
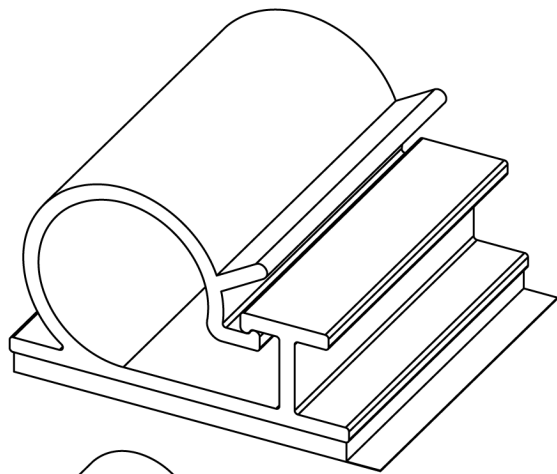

PART NO.	"A" HOLDING CAPACITY	"B"±.015	"C"±.020	"D" REF AT MAX. CAPACITY	FIG NO.
KKL-4-RT	1/4 [6.4]	3/4 [19.7]	3/4 [19.7]	9/16 [14.3]	1
KKL-8-RT	1/2 [12.7]	1 [25.4]	1 [25.4]	27/32 [21.4]	2
KKL-12-RT	3/4 [19.1]			1 [25.4]	

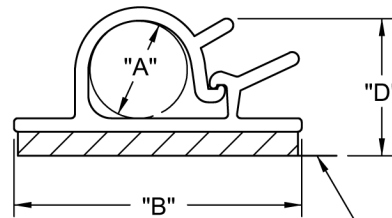
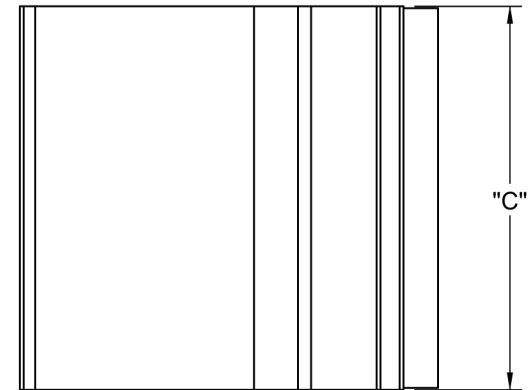
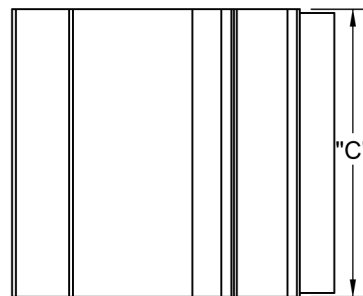

FIG 1.

TYPICAL RELEASE TAB LOCATION

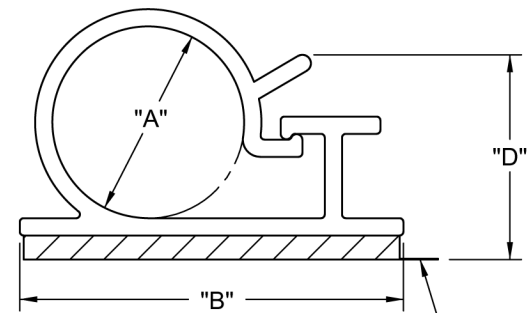

FIG 2.

TYPICAL RELEASE TAB LOCATION

NOTES:

1. MATERIAL: RIGID PVC (RMS-04)
ALSO AVAILABLE IN CLEAR PVC (RMS-32), BY SPECIAL ORDER.
2. COLOR: GRAY.
3. TAPE: 1/16 [1.6] THICK, DOUBLE SIDED ADHESIVE (RMS-15), WHITE LINER.
4. CUSTOM LENGTHS AVAILABLE BY SPECIAL ORDER.
5. COLOR BLACK AVAILABLE BY SPECIAL ORDER ONLY.
TO ORDER ADD SUFFIX "-BK" TO THE PART NO.

TITLE: KWIK-KLIP, TYPE "L"					DWG IN IN [MM]	
CREATED USING SOLIDWORKS	FILE #: KKL	DWN: S.M.	APP: -	FINAL		
TOLERANCES UNLESS NOTED .XX=±.010 .XXX=±.005 FRAC.=±1/64 ANG.=±1°	SHEET: 1 OF 1	SHEET SIZE: A	DT: 11/28/00	CHKD: -	PART #	PRINT TYPE
RE: RICHCO, INC.	RICHCO, INC.			SEE TABLE	CA	

G	SEE CO 200197 FOR CHANGES	SK	06/03/08
-	SEE ENGINEERING FOR REV A-F	---	-----
REV.	DESCRIPTION	ENGR.	DATE