

Home > 24941673734504F

Part Number: **24941673734504F**

General Description

Color	Blue
Series	249
Description	LED PANEL IND BLUE 14VDC STVP
Housing	Black Anodized
Mounting Method	Nut and Washer
Compliance	Front or Rear of Panel, UL-E15584
Termination	3/8-32 Solder
Terminal Type	TURRET
Terminal Other	249 SERIES (BLUE LED)
Mounting Hole Size	3/8"
Cap Material And Shape	Short cylindrical, fresnel, plastic
Cap Finish Description	Unfrosted or Transparent
Cap Color Desc	Blue
Metal Finish Desc	Black Anodized
Built In Resistor Desc	None
Hardware Desc	Aluminum
Panel Thickness	.031"
Lens Style	Stovepipe
Luminous Intensity Typical	1500 mcd
Forward Current mA	10 mA
Voltage	14 VDC
Operating Temperature	-20 +71
Storage Temperature	-40 +71

Dialight

249 Series

LED Panel Mount Indicators for 3/8" Mounting Hole



FEATURES / BENEFITS

- ▲ RoHS Compliant
- ▲ Long life – typically 100K hours
- ▲ Low power consumption – uses up to 90% less energy than an incandescent indicator
- ▲ Front or rear panel mounting
- ▲ Available in either cylindrical or stovepipe lens, unique internal fresnel design provides uniform illumination
- ▲ Aluminum black anodized housing enhances contrast
- ▲ No heat generate
- ▲ Resistant to shock and vibration
- ▲ Colors include – red, green, yellow and blue
- ▲ Polarity indication by terminal (+) denotes anode

APPLICATIONS

Dialight's 249 series LED panel mount indicator is available with a variety of LEDs as well as neon for 120 VAC operation. Typical applications for the 249 series include:

- Main and remote power indication
- Maintenance and warning indication
- Process Control
- Status indication
- Instrumentation
-and many more!

SPECIFICATIONS

- ▲ Voltage requirements: 3.6, 5, 10, 14 and 28 VDC*
(No current limiting resistor required)
 - ▲ Electrical connection: Turret terminals for wire wrapping
 - ▲ Mounting hole size: 0.375" (9.53 mm)
 - ▲ Operating temperature: -20° to +71°C
 - ▲ Storage temperature: -40° to +71°C
 - ▲ Max Panel thickness: 0.312" (7.92 mm)
 - ▲ Mounts with knurled flange nut, lock washer and nut.
- * Dialight recommends tolerance of 5% of specified voltage range

STOVEPIPE LENS

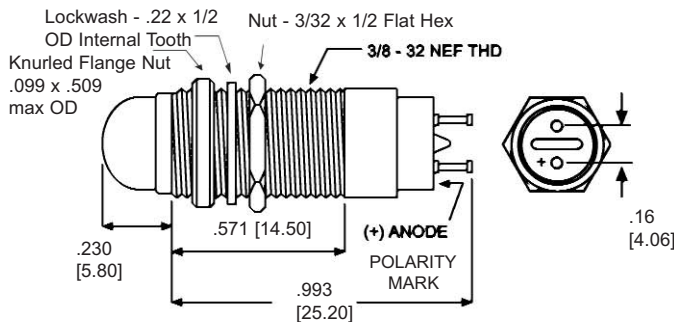

Figure 1

NOTES:

1. Dimensions in inches [mm]
2. All measurements are typical
3. Hardware includes knurled ring, lock washer & hex nut

CYLINDRICAL LENS 1

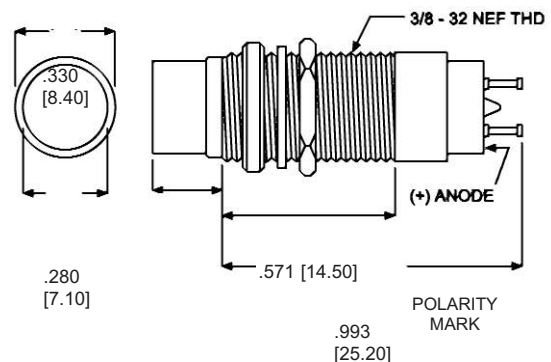

Figure 2

1. Cylindrical lens will provide wider viewing angle.

MATERIALS / FINISH

Description	Material	Finish
Mounting Body	Aluminum	Black Anodize
Terminals	Phosphor Bronze	Fused Tin
Knurled Flange Nut	Aluminum	Black Anodize
Lock Washer	Phosphor Bronze	White Nickel Plated
Nut	Brass	White Nickel Plated

STOVEPIPE CAP

CYLINDRICAL CAP

PART NUMBER	COLOR	VOLTAGE (VDC)*	CURRENT (mA)	INTENSITY TYP (mcd)	FIGURE
249-4162-3734-504F	Blue	3.5**	10	1500	1
249-7867-3731-504F	Red	3.6	20	170	1
249-7967-3732-504F	Green	3.6	20	100	1
249-8067-3733-504F	Yellow	3.6	20	150	1
249-4164-3734-504F	Blue	5	10	1500	1
249-7868-3731-504F	Red	5	20	170	1
249-7968-3732-504F	Green	5	20	100	1
249-8068-3733-504F	Yellow	5	20	150	1
249-4166-3734-504F	Blue	10	10	1500	1
249-7870-3731-504F	Red	10	20	170	1
249-7970-3732-504F	Green	10	20	100	1
249-8070-3733-504F	Yellow	10	20	150	1
249-4167-3734-504F	Blue	14	10	1500	1
249-7871-3731-504F	Red	14	20	170	1
249-7971-3732-504F	Green	14	20	100	1
249-8071-3733-504F	Yellow	14	20	150	1
249-4168-3734-504F	Blue	28	10	1500	1
249-7872-3731-504F	Red	28	20	170	1
249-7972-3732-504F	Green	28	20	100	1
249-8072-3733-504F	Yellow	28	20	150	1

PART NUMBER	COLOR	VOLTAGE (VDC)*	CURRENT (mA)	INTENSITY TYP (mcd)	FIGURE
249-4162-3334-504F	Blue	3.5**	10	700	2
249-7867-3331-504F	Red	3.6	20	55	2
249-7967-3332-504F	Green	3.6	20	40	2
249-8067-3333-504F	Yellow	3.6	20	75	2
249-4164-3334-504F	Blue	5	10	700	2
249-7868-3331-504F	Red	5	20	55	2
249-7968-3332-504F	Green	5	20	40	2
249-8068-3333-504F	Yellow	5	20	75	2
249-4166-3334-504F	Blue	10	10	700	2
249-7870-3331-504F	Red	10	20	55	2
249-7970-3332-504F	Green	10	20	40	2
249-8070-3333-504F	Yellow	10	20	75	2
249-4167-3334-504F	Blue	14	10	700	2
249-7871-3331-504F	Red	14	20	55	2
249-7971-3332-504F	Green	14	20	40	2
249-8071-3333-504F	Yellow	14	20	75	2
249-4168-3334-504F	Blue	28	10	700	2
249-7872-3331-504F	Red	28	20	55	2
249-7972-3332-504F	Green	28	20	40	2
249-8072-3333-504F	Yellow	28	20	75	2

* Dialight recommends tolerance of 5% of specified voltage range

** VF typical - Requires current limiting resistor

Dialight reserves the right to make changes at any time in order to supply the best product possible.

