

## PWT50



- Patented installation tool with 180° opening allows easy loading of maximum bundle diameters to speed installation, providing the lowest installed cost
- \*\* Order number of tools required.

■ Part Number	PWT50
■ RoHS Compliancy Status	RoHS directive is not applicable
■ Part Description	1/2" <i>Pan-Wrap™</i> Installation Tool. For use with PW50F <i>Pan-Wrap™</i> Split Harness Wrap.
■ Material	Polyethylene
■ Color	White
■ For Use With	PW50F-
■ Pricing Description	.50"(12.7mm) Panwrap tool
■ Min. Order UOM	PC
■ Min. Order Qty.	1
■ BOM Qty. (# of Pkgs.)	

THIS COPY IS PROVIDED ON A RESTRICTED BASIS AND IS NOT TO BE USED IN ANY WAY DETRIMENTAL TO THE INTERESTS OF PANDUIT CORP.

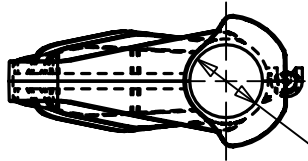
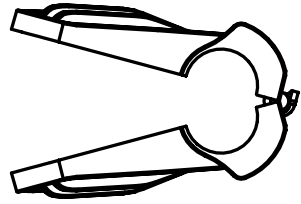

'A'  $\varnothing$   
(MIN)

PANDUIT PART NO.	DIMENSIONS			MAXIMUM BUNDLE DIAMETER	USE WITH PANDUIT PART NO.	WEIGHT lbs 10 (g) pcs.
	A	B	'C'			
PWT50	0.560 (14.22)	4.33 (109.98)	3.39 (86.0)	0.55 (13.97)	PW50	0.54 (244.94)
PWT75	0.860 (21.84)			0.81 (20.57)	PW75	0.82 (371.95)
PWT100	1.12 (28.45)	4.65 (118.11)	3.63 (92.2)	1.11 (28.19)	PW100	1.18 (535.24)
PWT150	1.68 (42.67)	5.38 (136.65)	4.53 (115.06)	1.67 (42.42)	PW150	2.32 (1052.3)

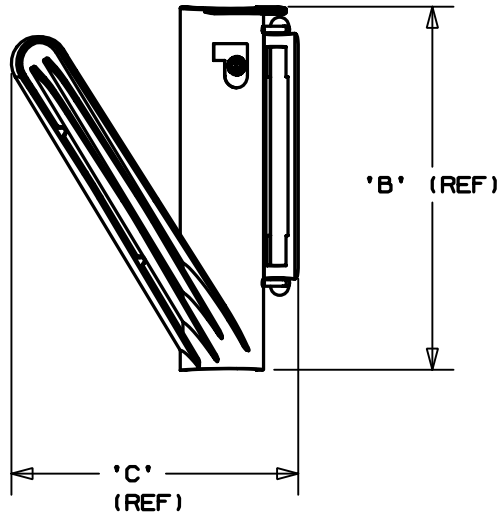

NOTES:  
1. MATERIAL: ABS  
COLOR: WHITE

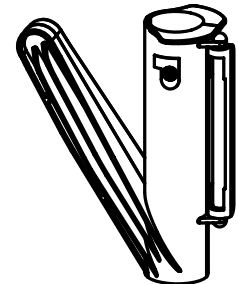

DIMENSIONS IN BRACKETS ARE METRIC [ mm ]	
CAD FILENAME/LAYERS G02607DD_PB_PWT_01	
<b>PANDUIT</b> CORP. TINLEY PARK, ILLINOIS	
PAN-WRAP APPLICATION TOOL (PWT__)	
UNLESS OTHERWISE SPECIFIED, DIMENSIONAL TOLERANCES ARE: (.X) $\pm 0.05$ (1.3) (.XXX) $\pm 0.010$ (0.25) (.XX) $\pm 0.02$ (0.5) ANGLES $\pm 5^\circ$	UNLESS OTHERWISE SPECIFIED, ALL DIMENSIONS ARE GIVEN IN INCHES, THIRD ANGLE PROJECTION.
DRAWN BY JAD	MAT'L: NONE
DATE 10/8/02	SEE NOTE 1
DRW'D	GB2607DD
	A
	SIZE

1	8/17/04	JAD		ADD PWT100, PWT150, AND 'C' DIM TO TABLE	GB2607DD	1			
REV	DATE	BY	CHK	DESCRIPTION	ECN	R	CUST	SUP	