

Current refinements (click  to remove)

[Search Tips](#) 
 Region  USA Product Family  Fork Terminal, Vinyl Insulated – Funnel Entry Text Search: 'PV18-10F-MY'

Your search criteria matched only one product, shown below.

- Fork design provides for fast and easy installation, without the need to remove fastener
- Insulation support helps to prevent wire damage in bending applications
- Brazed seam protects terminal barrel from splitting during the crimp process
- UL Flammability UL 94V-0, maximum insulation temperature 221°F (105°C)
- Internal barrel serrations assure good wire contact and maximum tensile strength
- UL and CSA rated up 600 V per UL 486

‡UL and CSA approved tooling/product combinations.

Note: Wire sizes #26 – #22 AWG, are not UL Listed or CSA Certified.

Part Number:	PV18-10F-MY
RoHS Compliancy Status:	Compliant
Note:	PV18-10F-MY replaces PV18-10F-M
Part Description:	Fork Terminal, vinyl insulated, funnel entry, 22 – 16 AWG, #10 stud size.
CSA Certified:	Yes
UL Listed:	Yes
Length (In.):	.93
Width (In.):	.35
Clearance:	.25
Max. Ins.:	.150
Panduit Color Code:	Red
Stud Size:	#10
Tool:	CT-100A‡, CT-600-A‡, CT-1550‡, CT-1551‡, CT-2500‡
Wire Range:	22 – 16 AWG
Min. Order UOM:	PC
Min. Order Qty.:	1000
BOM Qty. (# of Pkgs.)	

[Add to My Catalog](#)

 Please [register](#) to utilize the 'Bill of Materials', 'Submit Quotes' and 'My Catalog' features.

PANDUIT PART NUMBER		STUD SIZE	DIMENSIONS in.				
PREFIX	PK		A ±.03	W ±.01	C ±.02	M ±.03	H ±.01
PV18-6F	-C -M -MY	#6	.86 (21,8)	.30 (7,6)	.21 (5,3)	.69 (17,5)	.15 (3,8)
PV18-6FN*	-C -M -MY	#6	.85 (21,6)	.24 (6,1)	.21 (5,3)	.69 (17,5)	.15 (3,8)
PV18-8F	-C -M -MY	#8	.93 (23,6)	.32 (8,1)	.25 (6,4)	.73 (18,5)	.17 (4,3)
PV18-10F	-C -M -MY	#10	.93 (23,6)	.35 (8,9)	.25 (6,4)	.75 (19,1)	.20 (5,1)
PV18-10FN*	-C -M -MY	#10	.93 (23,6)	.31 (7,9)	.25 (6,4)	.75 (19,1)	.20 (5,1)

Notes:

1. Used for:

- A. 600 max voltage rating (1000 V. max in signs, fixtures, & luminaries)
- B. #22-16 AWG Solid or stranded copper wire range, 221°F (105°C) max temp rating with CT-1550, CT-1551 installation tools
- C. #22-18 AWG Solid or stranded copper wire range, 167°F (75°C) max temp rating with CT-100 installation tool

2. Wire strip length: 5/16 ^{+1/32} ₀ (7,9 ^{+0.8} ₀)

3. Package Quantity (Suffix to basic part no.):
 A. Standard -C=100
 B. Bulk -M=1000, -MY=1000

4. Material:
 A. Stamping: .032 (.81) thick tin plated copper
 B. Housing: Red vinyl

5. Dimensions in brackets are in millimeters

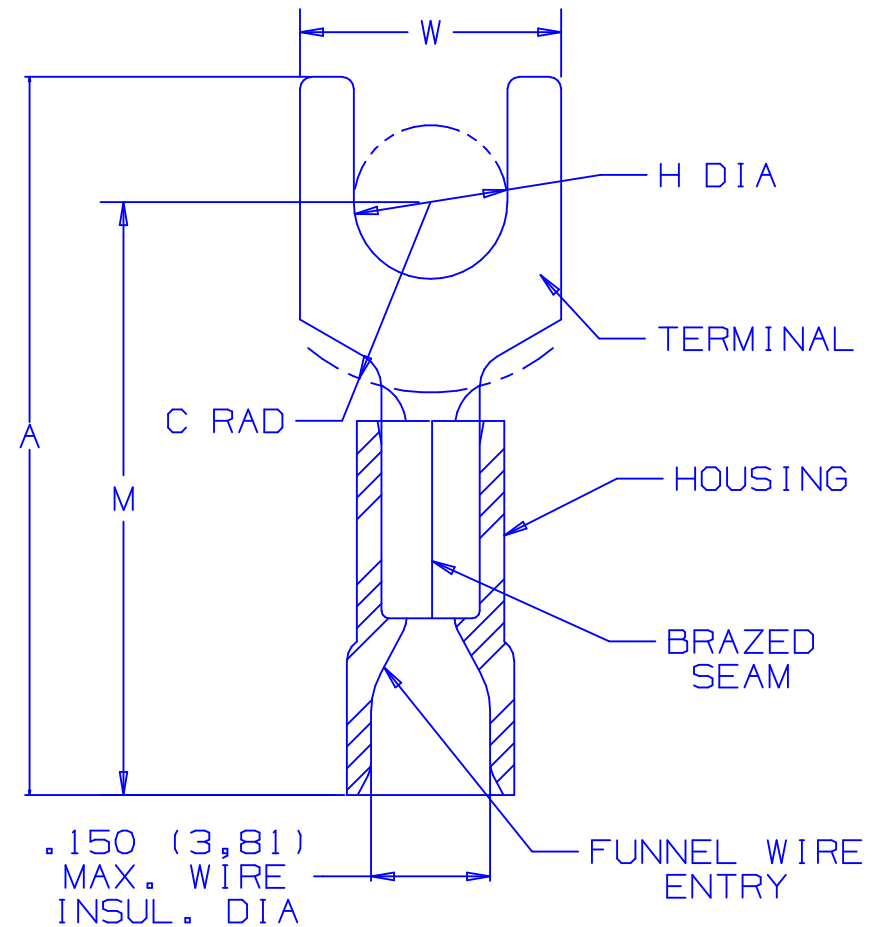

* PV18-6FN and PV18-10FN are not UL listed or CSA certified.



LISTED
587H
E52164

CERTIFIED
LR31212

A41194_06



TINLEY PARK, ILLINOIS

2PC. VINYL INSULATED,
#22-18 BARREL, FORKS

06	5/05	JHNU		ADDED PACKAGING CODE "MY" TO DRAWING.			
05	1/01	KMDSKB		CAD FILE SPEC. WAS N41194AA_PCD_04	08938	JAC	CCH
04	11/00	EJS		MAX. WIRE INSUL. DIA. WAS .158. REMOVED TOOLS CT-500, CT-550, REMOVED OBSOLETE PART PV18-14F, UPDATED NOTE 1-A TO 1000 V. MAX IN SIGNS, FIXTURES & LUMINARIES, ADDED NOTE "**"	08839		
03	5/99	JKDSKB		ADDED CT-1551 & CT-1550 TOOLS	07634	JW	TRO
02	1/95	MS	RLS	UPDATED NOTES AND DIMENSIONS	02842	LA	TFKE
01	3/91	DL	DL	TANG WIDTH INCREASED PART NO PV18-6F, PV18-8F, PV18-10F		LA	KS
REV	DATE	BY	CHK	DESCRIPTION	ECN #	CUST	PM

DRAWN BY	CHK'D	SCALE	DRAWING NO.
FES	FS	NONE	A41194