

Current refinements (click to remove)

[Search Tips](#)
 Region USA Product Family Ring Terminal, Vinyl Insulated – Funnel Entry Text Search: 'PV14-6R-C'

Your search criteria matched only one product, shown below.

- Insulation support helps to prevent wire damage in bending applications
- Ring tongue design assures a secure connection in high vibration applications
- Brazed seam protects terminal barrel from splitting during the crimp process
- UL Flammability UL 94V-0, maximum insulation temperature 221°F (105°C)
- Internal barrel serrations assure good wire contact and maximum tensile strength
- UL and CSA rated up 600 V per UL 486

‡UL and CSA approved tooling/product combinations.

Note: Wire sizes #26 – #22 AWG, are not UL Listed or CSA Certified.

Part Number:	PV14-6R-C
RoHS Compliance Status:	Compliant
Part Description:	Ring Terminal, 16 – 14 AWG, #6 stud size, vinyl insulated, funnel entry.
Product Type:	Terminals
CSA Certified:	Yes
UL Listed:	Yes
Length (In.):	.92
Length (mm):	23.4
Width (In.):	.31
Width (mm):	7.87
Clearance:	.25
Max. Ins.:	.170
Panduit Color Code:	Blue
Stock:	.03
Stud Size:	#6
Tool:	CT-100A‡, CT-600-A‡, CT-1550‡, CT-1551‡, CT-2500‡
Wire Range:	16 – 14 AWG
Min. Order UOM:	PC
Min. Order Qty.:	100
BOM Qty. (# of Pkgs.)	
Add to My Catalog	

 Please [register](#) to utilize the 'Bill of Materials', 'Submit Quotes' and 'My Catalog' features.

PANDUIT PART NUMBER		STUD SIZE	DIMENSIONS in.				
			A ±.03	W ±.01	C ±.02	M ±.03	H ±.01
PV14-4R	-C -M	#4	.84 (21.3)	.25 (6.4)	.19 (4.8)	.71 (18.0)	.12 (3.1)
PV14-6RN	-C -M	#6	.84 (21.3)	.25 (6.4)	.19 (4.8)	.71 (18.0)	.15 (3.8)
PV14-6R	-C -M	#6	.92 (23.4)	.31 (7.9)	.25 (6.4)	.76 (19.3)	.15 (3.8)
PV14-8R	-C -M	#8	.92 (23.4)	.31 (7.9)	.25 (6.4)	.76 (19.3)	.17 (4.3)
PV14-10R	-C -M	#10	.92 (23.4)	.31 (7.9)	.25 (6.4)	.76 (19.3)	.20 (5.1)
PV14-14R	-C -M	1/4"	1.12 (28.5)	.46 (11.7)	.38 (9.7)	.89 (22.6)	.27 (6.9)
PV14-56R	-C -M	5/16"	1.12 (28.5)	.46 (11.7)	.38 (9.7)	.89 (22.6)	.34 (8.6)
PV14-38R	-L -M	3/8"	1.21 (30.7)	.53 (13.5)	.43 (10.9)	.94 (23.9)	.40 (10.2)
PV14-12R	-L	1/2"	1.42 (36.1)	.72 (18.3)	.53 (13.5)	1.06 (26.9)	.52 (13.2)

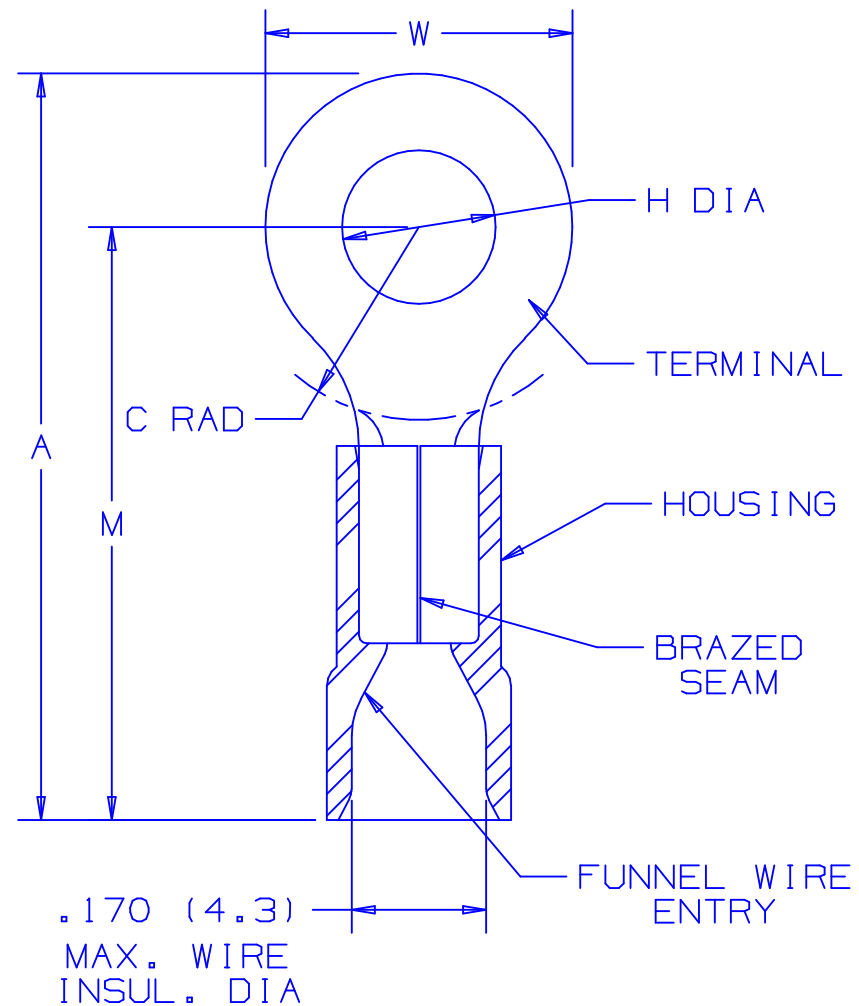

NOTES:

- UL LISTED & CSA CERTIFIED FOR
 - 600 V. MAX. VOLTAGE RATING (1000 V. MAX. IN SIGNS, FIXTURES AND LUMINAIRES.)
 - 18-14 AWG SOLID OR STRANDED COPPER WIRE & 221°F (105°C) MAX TEMP RATING, WITH THE CT-500 & CT-550, CT-1551, CT-1550 INSTALLATION TOOLS.
 - 16-14 AWG SOLID OR STRANDED COPPER WIRE & 167°F (75°C) MAX TEMP RATING WITH THE CT-100 INSTALLATION TOOLS.

2. MATERIAL:

- STAMPING - .032 (.8) THK COPPER, TIN PLATED
- HOUSING - VINYL, BLUE

3. STRIP LENGTH 5/16 +1/32_0

4. PACKAGE QTY.: -L=50
STD PKG-C=100
BULK PKG-M=1000

5. DIMENSIONS IN BRACKETS ARE IN MILLIMETERS



CERTIFIED
LR31212



LISTED
587H
E52164

A41184_05

REV	DATE	BY	CHK	DESCRIPTION	ECN #	CUST	PM
05	12/02	SAC		FOR PV14-12R DIM A WAS 1.41 & DIM M WAS 1.05			
04	5/02	SRB	SKB	CHANGED (DIMS.) TO 1 PLACE DECIMAL	10231	LA	TRO
03	4/02	SRB	SKB	ADDED PV14-12R	10171	LA	TRO

PANDUIT CORP.

TINLEY PARK, ILLINOIS

2PC. VINYL INSULATED,
#16-14 BARREL, RINGS

DRAWN BY FES	CHK'D	SCALE NONE	DRAWING NO. A41184
-----------------	-------	---------------	-----------------------