

Current refinements (click to remove)

[Search Tips](#)
 Region USA Product Family Locking Fork Terminal, Vinyl Insulated – Funnel Entry Text Search: 'PV10-6LF-L'

Your search criteria matched only one product, shown below.

- Locks in place for secure connection
- Fork design provides for fast and easy installation, without the need to remove fastener
- Insulation support helps to prevent wire damage in bending applications
- UL Flammability UL 94V-0, maximum insulation temperature 221°F (105°C)
- Internal barrel serrations assure good wire contact and maximum tensile strength
- UL and CSA rated to 600 V per UL 486

‡UL and CSA approved tooling/product combinations.

Part Number:	PV10-6LF-L
RoHS Compliance Status:	Compliant
Part Description:	Locking Fork Terminal, vinyl insulated, funnel entry, butted seam, 12 – 10 AWG, #6 stud size.
Product Type:	Terminals
CSA Certified:	Yes
UL Listed:	Yes
Length (In.):	1.03
Width (In.):	.30
Clearance:	.23
Max. Ins.:	.225
Panduit Color Code:	Yellow
Stock:	.04
Stud Size:	#6
Tool:	CT-100A‡, CT-600-A‡, CT-1550‡, CT-1551‡, CT-2500‡
Wire Range:	12 – 10 AWG
Min. Order UOM:	PC
Min. Order Qty.:	50

BOM Qty. (# of Pkgs.)

[Add to My Catalog](#)

 Please [register](#) to utilize the 'Bill of Materials', 'Submit Quotes' and 'My Catalog' features.

THIS COPY IS PROVIDED ON A RESTRICTED BASIS AND IS NOT TO BE USED IN ANY WAY DETRIMENTAL TO THE INTERESTS OF PANDUIT CORP.

PANDUIT PART NUMBER	STUD SIZE	DIMENSIONS in.				
		A $\pm .03$	W $\pm .01$	C $\pm .02$	M $\pm .03$	H $\pm .01$
PV10-6LF	#6	1.03 (26.16)	.30 (7.62)	.23 (5.84)	.80 (20.32)	.14 (3.56)
PV10-8LF	#8	1.05 (26.67)	.30 (7.62)	.23 (5.84)	.80 (20.32)	.16 (4.06)
PV10-10LF	#10	1.04 (26.42)	.34 (8.64)	.23 (5.84)	.80 (20.32)	.19 (4.83)
PV10-14LF	1/4"	1.19 (30.23)	.46 (11.68)	.36 (9.14)	.90 (22.86)	.25 (6.35)

NOTES:

- UL LISTED AND CSA CERTIFIED FOR:
 - 600V. MAX. VOLTAGE RATING (1000V. MAX. IN SIGNS, FIXTURES & LUMINARIES)
 - 221°F (105°C) MAX. TEMP. RATING
 - #12-10 STRANDED COPPER WIRE ONLY
- PACKAGE QTY: STD. PKG. -L=50
BLK. PKG. -D=500
- MATERIAL:
 - STAMPING - .04 (1.02) THK. COPPER TIN PLATED
 - HOUSING - VINYL, YELLOW
- DIMENSIONS IN BRACKETS ARE IN mm.
- INSTALLATION TOOLS: CT-550, CT-1550, CT-1551
- WIRE STRIP LENGTH: 5/16 \pm 1/32

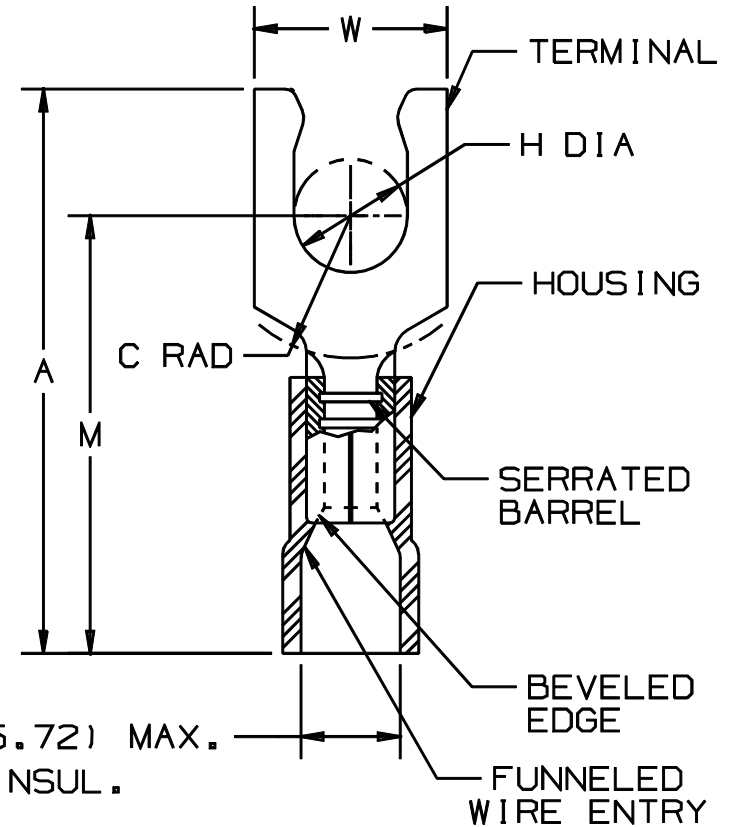

LISTED
587H
E52164



CERTIFIED
LR31212

A41226_09

09	1/01	KMD		CAD FILE SPEC. WAS N41226AA_PCD_08					TINLEY PARK, ILLINOIS		
08	1/97	JAMB		UPDATE NOTES, MAX WIRE INSUL. DIA. WAS .230	05447						
07	12/94	TH	RLS	UPDATED NOTES AND DIMENSIONS	02705	LA	TFKE	#12-10 BARREL, FUNNELED VINYL INSULATED LOCKING FORK, .225 (5.72) MAX. WIRE INSUL. DIAMETER			
06	2/91	RH	RLS	REVISED NOTES/TEMP. & TOOLS	00328	LA	KRS				
REV	DATE	BY	CHK	DESCRIPTION	ECN #	CUST	PM	DRAWN BY DAW	CHK'D LA	SCALE NONE	DRAWING NO. A41226