

Current refinements (click to remove)

[Search Tips](#)
 Region USA Product Family Fork Terminal, Vinyl Insulated – Funnel Entry Text Search: 'PV10-6F-L'

Your search criteria matched only one product, shown below.

- Fork design provides for fast and easy installation, without the need to remove fastener
- Insulation support helps to prevent wire damage in bending applications
- Brazed seam protects terminal barrel from splitting during the crimp process
- UL Flammability UL 94V-0, maximum insulation temperature 221°F (105°C)
- Internal barrel serrations assure good wire contact and maximum tensile strength
- UL and CSA rated up 600 V per UL 486

‡UL and CSA approved tooling/product combinations.

Note: Wire sizes #26 – #22 AWG, are not UL Listed or CSA Certified.

Part Number:	PV10-6F-L
RoHS Compliancy Status:	Compliant
Part Description:	Fork Terminal, vinyl insulated, funnel entry, 12 – 10 AWG, #6 stud size.
Product Type:	Terminals
CSA Certified:	Yes
UL Listed:	Yes
Length (In.):	1.01
Width (In.):	.31
Clearance:	.25
Max. Ins.:	.225
Panduit Color Code:	Yellow
Stock:	.04
Stud Size:	#6
Tool:	CT-100A‡, CT-600-A‡, CT-1550‡, CT-1551‡, CT-2500‡
Wire Range:	14 – 10 AWG
Min. Order UOM:	PC
Min. Order Qty.:	50

BOM Qty. (# of Pkgs.)

[Add to My Catalog](#)

 Please [register](#) to utilize the 'Bill of Materials', 'Submit Quotes' and 'My Catalog' features.

THIS COPY IS PROVIDED ON A RESTRICTED BASIS AND IS NOT TO BE USED IN ANY WAY DETRIMENTAL TO THE INTERESTS OF PANDUIT CORP.

PANDUIT PART NUMBER	STUD SIZE	DIMENSIONS in.				
		A ±.03	W ±.01	C ±.02	M ±.03	H ±.01
PV10-6F	#6	1.01 (25.65)	.31 (7.87)	.25 (6.35)	.81 (20.57)	.14 (3.56)
PV10-8F	#8	1.04 (26.42)	.37 (9.40)	.25 (6.35)	.81 (20.57)	.17 (4.32)
PV10-10F	#10	1.04 (26.42)	.37 (9.40)	.25 (6.35)	.81 (20.57)	.20 (5.08)
PV10-14F	1/4"	1.14 (28.96)	.49 (12.45)	.32 (8.13)	.88 (22.35)	.26 (6.60)

NOTES:

1. Used for:

A. #14-10 AWG Solid or stranded copper wire range, 600V max voltage rating, and 221°(105°C) max temp rating with CT-550 installation tool #12 str or sol & #10 str w/ CT-1551, CT-1550 installation tool

B. #12-10 AWG Solid or stranded copper wire range, 300V max voltage rating, and 167°F (75°C) max temp rating with CT-100 installation tool

2. Wire strip length: 5/16 ^{+1/32} ₀ (7.9 ^{+0.8} ₀)

3. Package Quantity (Suffix to basic part no.)
 A. Standard -L=50
 B. Bulk -D=500

4. Material:
 A. Stamping: .040 (1.02) thick tin plated copper
 B. Housing: Yellow vinyl

5. Dimensions in brackets are in millimeters

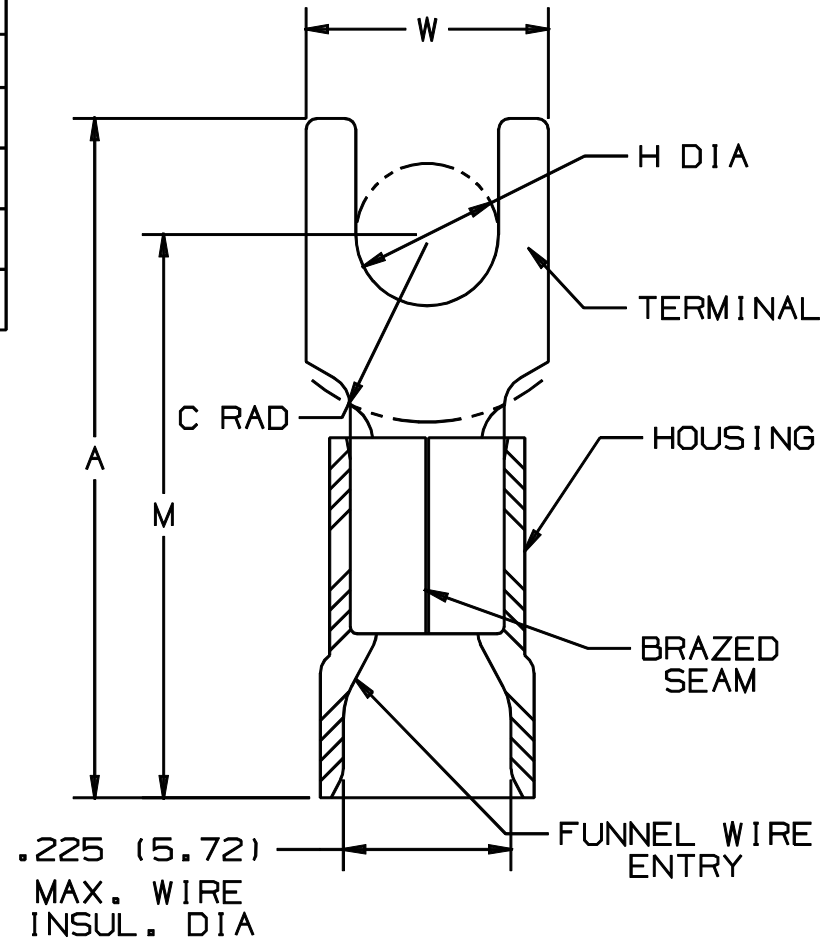

LISTED
587H
E52164



CERTIFIED
LR31212

A41189_03

03	1/01	KMD		CAD FILE SPEC. WAS N41189AA_PCD_02				PANDUIT CORP. TINLEY PARK, ILLINOIS			
02	5/99	JKD		ADDED CT-1551 & CT-1550 TOOLS	07634						
01	6-95	MS	RLS	UPDATED NOTES AND DIMENSIONS	03403	LA	KS	2PC. VINYL INSULATED, #12-10 BARREL, FORKS			
00	3-88	FS	LM	RELEASED		LA	JB				
REV	DATE	BY	CHK	DESCRIPTION	ECN#	CUST	PM	DRAWN BY FES	CHK'D FS	SCALE NONE	DRAWING NO. A41189