

Current refinements (click to remove)

[Search Tips](#) 
 [Region](#) **USA** [Product Family](#) **Flex Conductor, One-Hole, Standard Barrel with Window Lug** [Text Search:](#) 'LCAX4-38-L'

For Use with Flexible, Extra-Flexible, and Code Stranded Copper Conductors

- Can be used with code conductor and flex conductor class: G, H, I, K, M and Diesel Locomotive
- Generously beveled wire entry prevents bent back strands when inserting conductor into barrel
- Color-coded barrels marked with *PANDUIT* and specified competitor die index numbers for proper crimp die selection
- Inspection window to visually assure full conductor insertion
- Tin-plated to inhibit corrosion
- UL Listed and CSA Certified to 35 KV** and temperature rated to 90°C when crimped with *PANDUIT* and specified competitor crimping tools and dies
- American Bureau of Shipping Approved

Related Products

- [Contour Crimp™ Control...](#)
- [Die Type, Battery Powered Hydraulic...](#)
- [Die Type, Battery Powered Hydraulic...](#)
- [CD-2001 Crimping Dies](#)
- [Die Type, Manual Hydraulic, 14 Ton,...](#)
- [Die Type, Remote Hydraulic, 14 Ton,...](#)
- [More...](#)

Part Number:	LCAX4-38-L
RoHS Compliancy Status:	Compliant
Part Description:	Flex Lug, #4 AWG, 3/8" Stud Hole
Length (In.):	1.57
Length (mm):	39.9
Class G,H, I, K, M:	#4 AWG
Diesel Locomotive:	#5, #4, #3 AWG
Stud Hole Size (In.):	3/8
Tongue Width (In.):	.62
Barrel Length (In.):	.53
Angle:	Straight
Figure No.:	1
Panduit Color Code:	Gray
Panduit Die Index No.:	P29
Tongue Thickness:	.07
Tongue Type:	Standard
Tongue Width (mm):	15.7
Wire Strip Length (In.):	5/8
Min. Order UOM:	PC
Min. Order Qty.:	1
Burndy Die Index No.:	8
T&B Die Index No.:	29
BOM Qty. (# of Pkgs.)	

[Add to My Catalog](#)

 Please [register](#) to utilize the 'Bill of Materials', 'Submit Quotes' and 'My Catalog' features.

THIS COPY IS PROVIDED ON A RESTRICTED BASIS AND IS NOT TO BE USED IN ANY WAY DETRIMENTAL TO THE INTERESTS OF PANDUIT CORP.

Material	High Conductivity Seamless Copper Tube
Plating	Electro-Tin
Wire Size	4 STR/FLEX (ALL), 3 & 5 FLEX*
Wire Type	Stranded Copper: Class B & C, Compact, Class G, H, I, K, M, Locomotive (*Locomotive only)
Wire Strip Length	5/8 in.
Stud Size	3/8 in.
UL Listed Wire Connector	Yes, for applications up to 35kv. Consult cable manufacturer for voltage stress relief instructions with applications greater than 2000 volts.
UL Temperature Rating	90° C
C.S.A Certified Wire Connector	Yes
Panduit Color Code on Barrel	GRAY
Panduit Die Index No. on Barrel	P29
Alternate Industry Die Index No. () on Barrel	(8)

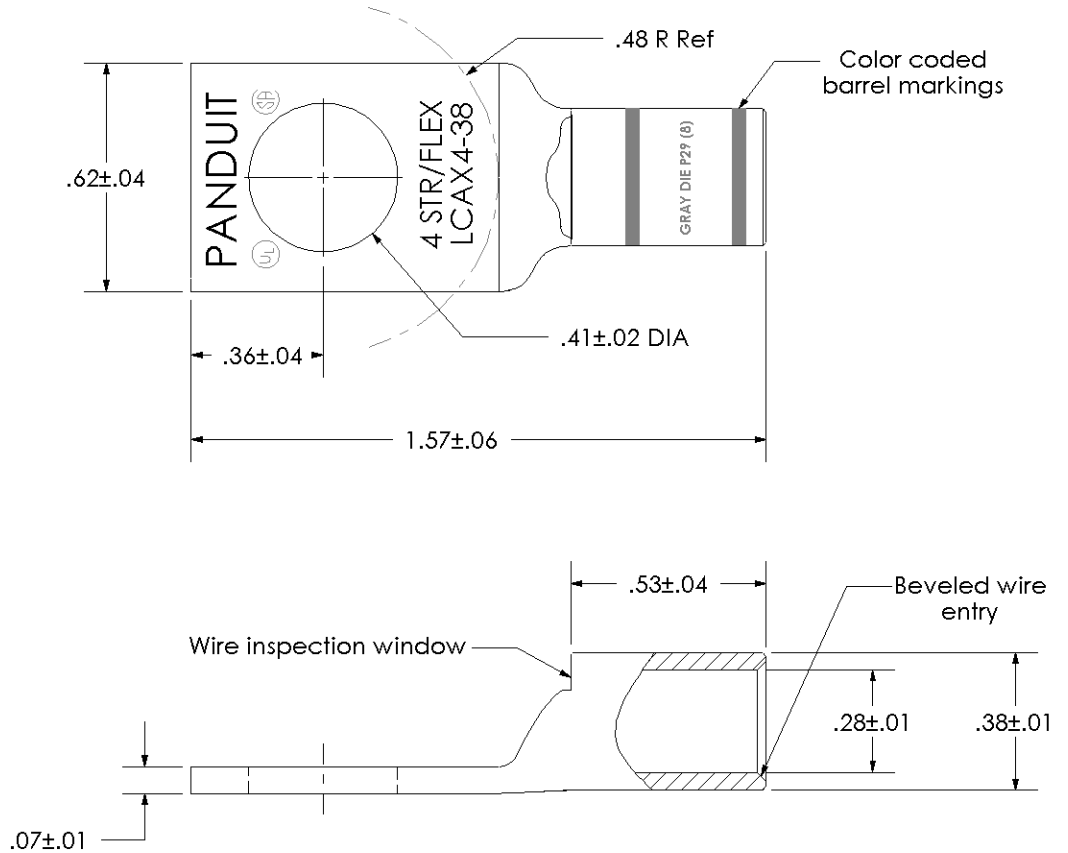

01	3/04	KLFU	TLCO	WIRE SIZE WAS: 4 STR/FLEX ADDED 3 & 5 FLEX, LOCOMOTIVE ONLY *NOTE	11610
REV	DATE	BY	CHK	DESCRIPTION	ECN

PANDUIT CORP. TINLEY PARK, ILLINOIS

LCAX4-38-L
Copper Lug - One-Hole, Standard Flex Barrel

SCALE N/A DRAWING NO / CAD FILE LCAX4-38-CUST