

HINGED STANDOFFS & KITS

Designers' Choice



HINGED STANDOFFS

APPLICATIONS UNLIMITED • TIME SAVING • SPACE SAVING
• INTERCONNECT CIRCUITS OR SERVICES WITHOUT DANGER OF SHORTING

MATERIAL:

Brass: per ASTM-B16

Finish: Zinc plate and Gold Iridite

FEMALE/FEMALE HINGE

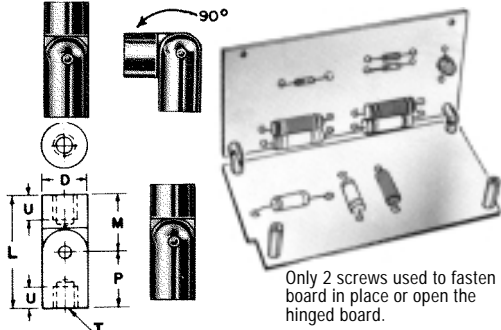

These standoffs mount at front of the board.



CAT. NO.	T THREAD	D DIA.	L LENGTH	U	M	P
351	4-40	.187	.750	.172	.375	.375
352	4-40	.187	1.000	.250	.375	.625
330	4-40	.187	1.250	.250	.625	.625
353	6-32	.250	.750	.172	.375	.375
354	6-32	.250	1.000	.250	.375	.625
331	6-32	.250	1.250	.250	.625	.625
355	8-32	.250	.750	.172	.375	.375
356	8-32	.250	1.000	.250	.375	.625
332	8-32	.250	1.250	.250	.625	.625

MALE/FEMALE HINGE

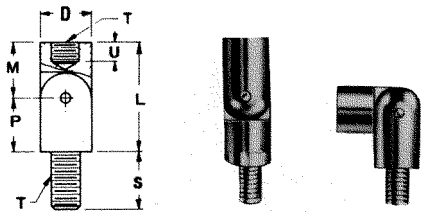

These standoffs mount at front of the board.



CAT. NO.	T THREAD	L LENGTH	D DIA.	S	U	P	M
333	4-40	.625	.187	.250	.172	.250	.375
334	4-40	.875	.187	.250	.250	.250	.625
335	6-32	.625	.250	.312	.172	.250	.375
336	6-32	.875	.250	.312	.250	.250	.625
337	8-32	.625	.250	.312	.172	.250	.375
338	8-32	.875	.250	.312	.250	.250	.625

MALE/MALE HINGE

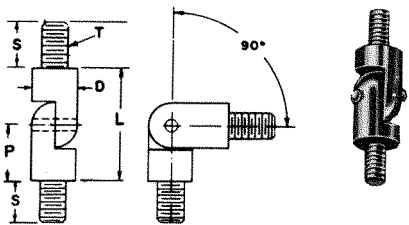

These standoffs mount at front of the board.



CAT. NO.	T THREAD	L LENGTH	D DIA.	S	P
357	4-40	.500	.187	.250	.250
358	6-32	.500	.250	.312	.250
359	8-32	.500	.250	.312	.250

SPACER/STANDOFF ORGANIZER



Maintain a neat complete inventory of the most frequently used spacers and standoffs in day-to-day operations. Choice of "8" different kits of the most popular spacers and standoffs. An assortment of various sizes and styles in Brass, Aluminum and Nylon with tapped or thru-hole. Metal cabinet designed to be stacked on one another or wall mounted. Clear plastic drawers labeled for easy identification.

THE FOLLOWING ORGANIZER KITS ARE AVAILABLE FROM STOCK!

1/4" ROUND THREADED

Brass Zinc Plated

Assortment of 1500 pcs. In 1/4", 3/8", 1/2", 3/4" and 1" lengths. With thread sizes of 4-40, 6-32 and 8-32. 100 pcs. Of each size complete with cabinet.

KIT. NO. STR-15

Aluminum Iridite Finish

Assortment of 1500 pcs. In 1/4", 3/8", 1/2", 3/4" and 1" lengths. With thread sizes of 4-40, 6-32 and 8-32. 100 pcs. Of each size complete with cabinet.

KIT. NO. STR-35

1/4" HEX THREADED

Brass Zinc Plated

Assortment of 1500 pcs. In 1/4", 3/8", 1/2", 3/4" and 1" lengths. With thread sizes of 4-40, 6-32 and 8-32. 100 pcs. Of each size complete with cabinet.

KIT. NO. STH-14

Aluminum Iridite Finish

Assortment of 1500 pcs. In 1/4", 3/8", 1/2", 3/4" and 1" lengths. With thread sizes of 4-40, 6-32 and 8-32. 100 pcs. Of each size complete with cabinet.

KIT. NO. STH-22

1/4" ROUND CLEAR

Brass Nickel Plated

Assortment of 1500 pcs. In 1/4", 3/8", 1/2", 3/4" and 1" lengths. With clearance holes for #4, #6 and #6. 100 pcs. Of each size complete with cabinet.

KIT. NO. SPR-13

Aluminum Iridite

Assortment of 1500 pcs. In 1/4", 3/8", 1/2", 3/4" and 1" lengths. With clearance holes for #4, #6 and #6. 100 pcs. Of each size complete with cabinet.

KIT. NO. SPR-34

1/4" ROUND CLEAR

Nylon 6/6

Assortment of 1500 pcs. In 1/4", 3/8", 1/2", 3/4" and 1" lengths. With clearance holes for #4, #6 and #6. 100 pcs. Of each size complete with cabinet.

KIT. NO. SPR-8

1/4" HEX MALE/FEMALE

Brass Nickel Plated

Assortment of 750 pcs. In 1/2", 3/4", 1", 1 1/4" and 1 1/2" lengths. With thread sizes of 4-40, 6-32 and 8-32. 50 pcs. Of each size complete with cabinet.

KIT. NO. STH-19