

NICKEL METAL HYDRIDE BATTERIES

Developed to meet the requirement for increasingly higher levels of energy demanded by today's electronic products, our Nickel Metal Hydride batteries can offer up to three times the capacity of the same size standard Nickel Cadmium batteries. Due to their increased capacity and energy density features, users can expect a longer time between charges and longer running time.



Features:

- High energy density
- Rapid charge
- Excellent life cycle
- Excellent discharge profile

Applications:

- Cameras
- Cellular mobile telecom products
- Notebook PC's
- Personal digital assistants (PDA)
- Portable VCRs, TVs, portable stereos and CD players

- Cordless vacuum cleaners
- Power Tools
- R/C Hobby

Technical Data									
Model No.	Size	Nominal Voltage (V)	Minimum Capacity (1/5C) (mAh)	Rapid Charge		Dimensions		Approximate Weight oz (g)	
				Current (mA)	Hours (h)	Diameter inch (mm)	Height inch (mm)		
HHR60AAAH¹	AAA	1.2	500	250	2.4	0.41+0/-0.03 (10.5+0/-0.7)	1.75+0/-0.04 (44.5+0/-1.0)	0.42 (12)	
HHR70AAAJ	AAA	1.2	720	650	1.2	0.41+0/-0.03 (10.5+0/-0.7)	1.75+0/-0.04 (44.5+0/-1.0)	0.46 (13)	
HHR75AAA/B	AAA	1.2	700	450	1.7	0.41+0/-0.03 (10.5+0/-0.7)	1.75+0/-0.04 (44.5+0/-1.0)	0.42 (12)	
HHR120AA	4/5AA	1.2	1150	1200	1.2	0.57+0/-0.03 (14.5+0/-0.7)	1.69+0/-0.04 (43.0+0/-1.0)	0.81 (23)	
HHR150AA	AA	1.2	1500	1500	1.2	0.57+0/-0.03 (14.5+0/-0.7)	1.97+0/-0.04 (50.0+0/-1.5)	0.92 (26)	
HHR210AA/B	AA	1.2	2000	1200	2	0.57+0/-0.03 (14.5+0/-0.7)	1.99+0/-0.5 (50.5+0/-1.0)	1.02 (29)	
HHR200A	4/5A	1.2	2000	2000	1.2	0.67+0/-0.03 (17.0+0/-0.7)	1.69+0/-0.06 (43.0+0/-1.5)	1.13 (32)	

HHR210A	A	1.2	2100	2100	1.2	0.67+0/-0.03 (17.0+0/-0.7)	1.97+0/-0.06 (50.0+0/-1.5)	1.34 (38)	
HHR210AH¹	A	1.2	1900	-----	-----	0.67+0/-0.03 (17.0+0/-0.7)	1.97+0/-0.06 (50.0+0/-1.5)	1.34 (38)	
HHR370AH¹	18670 (L-fat-A)	1.2	3500	-----	-----	0.72+0/-0.03 (18.2+0/-0.7)	2.64+0/-0.06 (67.0+0/-1.5)	2.12 (60)	
HHR330APH	18670 (L-fat-A)	1.2	3200	1650	2.4	0.72+0/-0.03 (18.2+0/-0.7)	2.64+0/-0.06 (67.0+0/-1.5)	2.12 (60)	
HHR380A²	L-A	1.2	3700	2000	2.3	0.67+0/-0.03 (17.0+0/-0.7)	2.64+0/-0.06 (67.0+0/-1.5)	1.87 (53)	
HHR450A²	18670 (L-fat-A)	1.2	4200	2000	2.7	0.72+0/-0.03 (18.2+0/-0.7)	2.64+0/-0.06 (67.0+0/-1.5)	2.12 (60)	
HHR200SCP³	4/5SC	1.2	1900	2000	1.2	0.91+0/-0.04 (23.0+0/-1.0)	1.34+0/-0.06 (34.0+0/-1.5)	1.50 (42)	
HHR250SCH¹	SC	1.2	2500	1250	2.4	0.91+0/-0.04 (23.0+0/-1.0)	1.69+0/-0.06 (43.0+0/-1.5)	1.94 (55)	
HHR260SCP	SC	1.2	2600	2450	1.2	0.91+0/-0.04 (23.0+0/-1.0)	1.69+0/-0.06 (43.0+0/-1.5)	1.94 (55)	
HHR300SCP³	SC	1.2	2800	3000	1.2	0.91+0/-0.04 (23.0+0/-1.0)	1.69+0/-0.06 (43.0+0/-1.5)	1.95 (55)	
HHR300CH¹	C	1.2	3300	3100	2.4	1.02+0/-0.04 (25.8+0/-1.0)	1.97+0/-0.06 (50.0+0/-1.5)	2.82 (80)	
HHR650D³	D	1.2	6500	6500	1.2	1.30+0/-0.04 (33.0+0/-1.0)	2.39+0/-0.08 (60.8+0/-2.0)	6.0 (170)	
HHR900D	D	1.2	8250	4500	2.4	1.30+0/-0.04 (33.0+0/-1.0)	2.39+0/-0.08 (60.8+0/-2.0)	5.82 (165)	

1 H Type: Improved low rate charge characteristics at higher temperatures. Ideal for back-up applications (with appropriate charge control circuitry).
2 Mainly for PC applications.
3 Mainly for High Drain Applications such as Power Tools.

NICKEL METAL HYDRIDE BATTERIES: INDIVIDUAL DATA SHEET

HHR200A Cylindrical 4/5A size (HR 17/43)

Dimensions (with Tube) (mm)

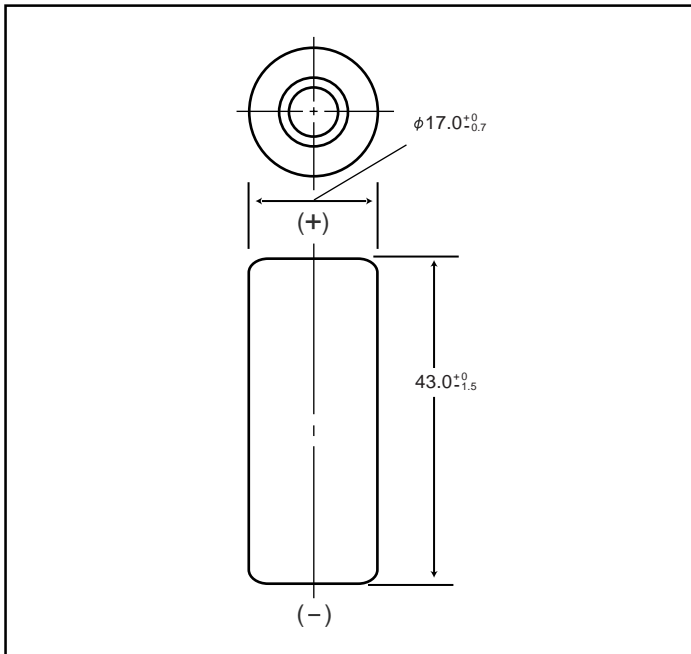

Typical Charge Characteristics

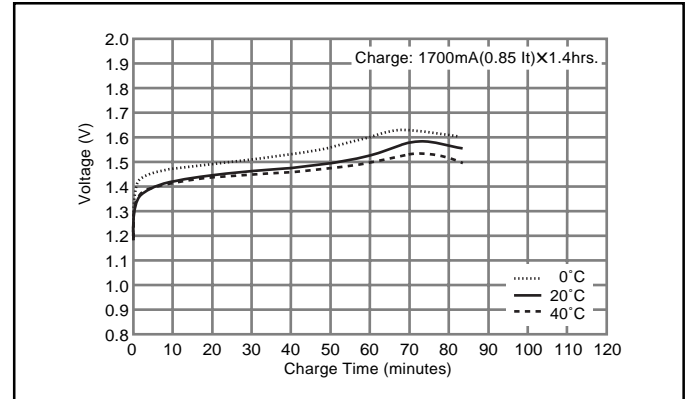

Typical Discharge Characteristics

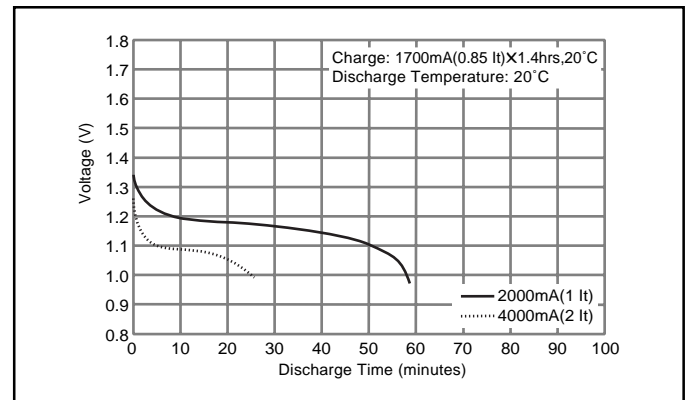
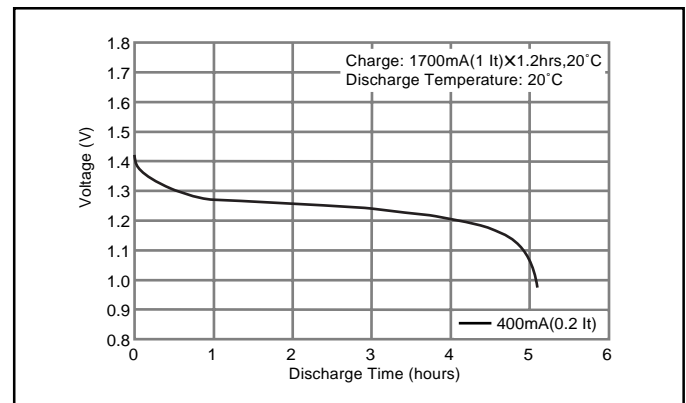

Specifications

	mm	inch
Diameter	17.0+0/-0.7	0.67+0/-0.03
Height	43.0+0/-1.5	1.69+0/-0.06
Approximate Weight	Grams	Ounces
	32	1.13

Nominal Voltage		1.2V		
Discharge Capacity*	Average**	2040 mAh		
	Rated (Min.)	2000 mAh		
Approx. Internal impedance at 1000Hz at charged state.		20mΩ		
Charge	Standard	200mA (0.1It) x 16hrs.		
	Rapid	2000mA (1It) x 1.2 hrs.		
Ambient Temperature	Charge	Standard	°C	°F
			0°C to 45°C	32°F to 113°F
	Rapid	0°C to 40°C	32°F to 104°F	
	Discharge	-10°C to 65°C		14°F to 149°F
		Storage	< 1 year	-20°C to 35°C
< 3 months			-20°C to 45°C	-4°F to 113°F
< 1 month	-20°C to 55°C		-4°F to 131°F	

* After charging at 0.1It for 16 hours, discharging at 0.2It.

** For reference only.

Battery performance and cycle life are strongly affected by how they are used. In order to maximize battery safety, please consult Panasonic when determining charge / discharge specs, warning label contents and unit design.

Note: [It] was previously expressed as [C]. [It] is an IEC standard expression for the amount of charge or discharge current and is expressed as:

$$It(A) = C_n (Ah)/1h.$$

- [It] is the reference test current in amperes
- [Cn] is the rated capacity of the cell or battery in Ampere-hours.
- n = the time base [hours] for which the rated capacity is declared

NICKEL METAL HYDRIDE BATTERIES

High-energy Batteries to Launch a New Era of Products



Overview

As electronic products have come to feature more sophisticated functions, more compact sizes and lighter weights, the sources of power that operate these products have been required to deliver increasingly higher levels of energy. To meet this requirement, nickel-metal hydride batteries have been developed and manufactured with nickel hydroxide for the positive electrode and hydrogen-absorbing alloys, capable of absorbing and releasing hydrogen at high-density levels, for the negative electrode. Because Ni-MH batteries have about twice the energy density of Ni-Cd batteries and a similar operating voltage as that of Ni-Cd batteries, they have become a mainstay in rechargeable batteries.

Construction

Nickel-metal hydride batteries consist of a positive plate containing nickel hydroxide as its principal active material, a negative plate mainly composed of hydrogen-absorbing alloys, a separator made of fine fibers, an alkaline electrolyte, a metal case and a sealing plate provided with a self-resealing safety vent. Their basic structure is identical to that of Ni-Cd batteries. With cylindrical nickel-metal hydride batteries, the positive and negative plates are separated by the separator, wound into a coil, inserted into the case, and sealed by the sealing plate through an electrically insulated gasket.

NICKEL METAL HYDRIDE BATTERIES - CONTINUED

Features

- **Similarity with Ni-Cd batteries**

These batteries have similar discharge characteristics to those of Ni-Cd batteries.

- **Double the energy density of conventional batteries**

Nickel-metal hydride batteries have approximately double the capacity compared with Panasonic's standard Ni-Cd batteries.

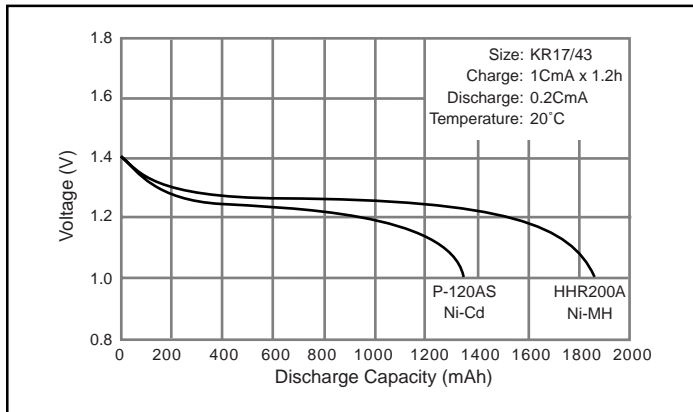

- **Cycle life equivalent to 500 charge and discharge cycles**

Like Ni-Cd batteries, nickel-metal hydride batteries can be repeatedly charged and discharged for about 500 cycles. (example: IEC charge and discharge conditions)

- **Rapid charge in approx. 1 hour**

Nickel-metal hydride batteries can be rapidly charged in about an hour using a specially designed charger.

- **Excellent discharge characteristics**

Since the internal resistance of nickel-metal hydride batteries is low, continuous high-rate discharge up to 3CmA is possible, similar to Ni-Cd batteries.

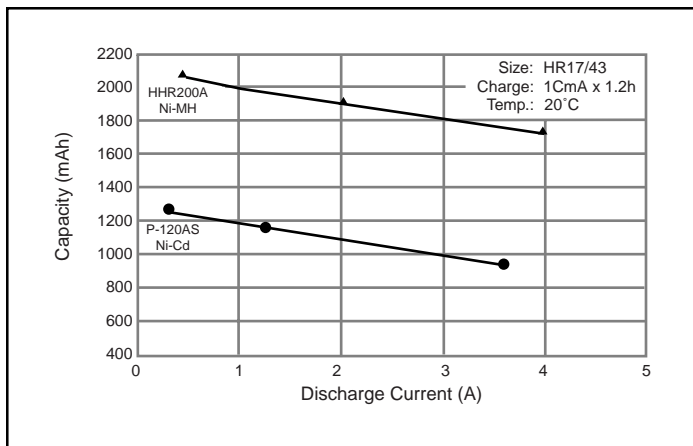

Five Main Characteristics

As with Ni-Cd batteries, nickel-metal hydride batteries have five main characteristics: charge, discharge, storage life, cycle life and safety.

1) Charge characteristics

Like Ni-Cd batteries, the charge characteristics of nickel-metal hydride batteries are affected by current, time and temperature. The battery voltage rises when the charge current is increased or when the temperature is low. The charge efficiency differs depending on the current, time, temperature and other factors.

Nickel-metal hydride batteries should be charged at a temperature ranging from 0°C to 40°C using a constant current of 1It or less. The charge efficiency is particularly good at a temperature of 10°C to 30°C. Repeated charge at high or low temperatures causes the battery performance to deteriorate. Furthermore, repeated overcharge should be avoided since it will downgrade the battery performance.

Refer to the section on recommended charge methods for details on how to charge the batteries.

- Charge characteristics

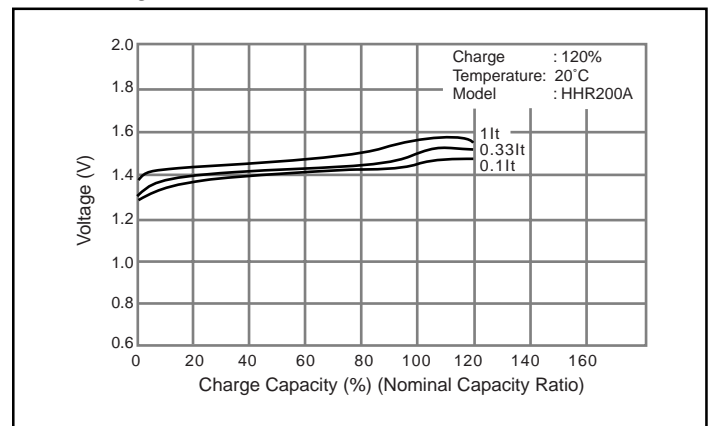

- Charge temperature characteristics at 1It charge

