



[Custom
Molded
Rubber](#)



[Custom
Colors!!](#)

[Home](#)

[About PacTec](#)

[Contact Us](#)

Login

[Click Here to Register](#)

Username

Password

[Forget your login info?](#)

[View Cart \(0\)](#)

[Advanced Search](#)

[Connector Search](#)

News

Sign up for our latest news and new product updates!

Email:

RM-178

External Dimensions: 8.1 x 17.1 x 1.7 in.

PCB Dimensions: 7.6 x 16.6 x 1.7 in.

Colors: Black
PC Bone

Materials: ABS-94VO
[Material Specs](#)

Components:

- Top and Bottom Covers
- Assembly Screws
- 2 Panels
- Mounting Brackets



[View Drawing](#)



[Custom Colors!!](#)



[Free Samples of
New Products Available!](#)



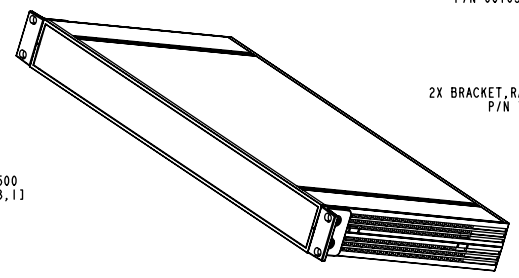
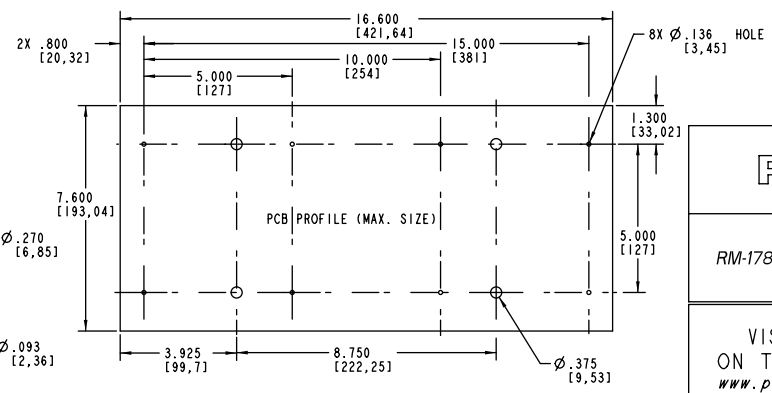
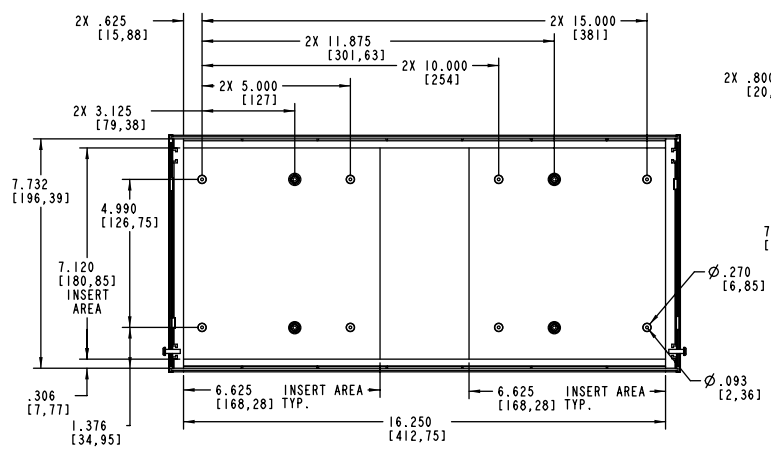
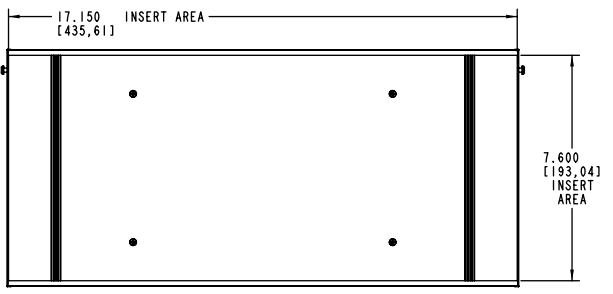
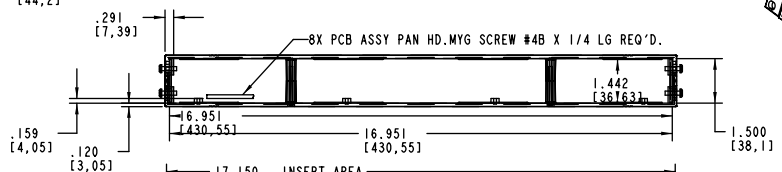
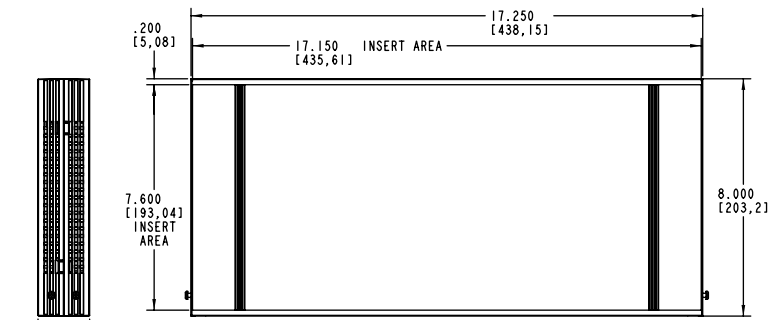

SCALE 0.500

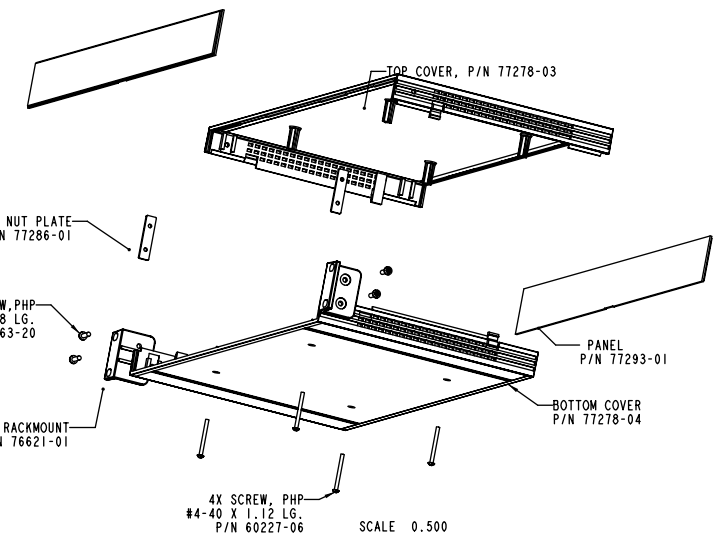

SCALE 0.500

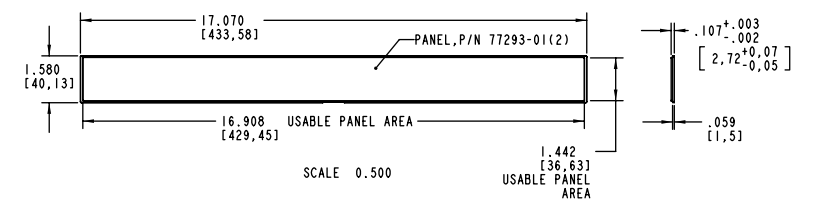

SCALE 0.500

PACNTEC®
1-800-220-9800

RM-178 RACKMOUNT ENCLOSURE

VISIT **PACNTEC®**
ON THE WORLD WIDE WEB
www.pactecenclosures.com

COLOR	MATERIAL	CODE
COLOR	U.L. RATED 94V-0	
BLACK	028	
PC BONE	060	

DRAWING NUMBER	REV
77401	C