

Datasheet
Modular Plugs and Jacks Overview

[Home > Products > Modular Plugs and Jacks > Datasheet]

44170-0004

Modular Jack, Right Angle, Shielded, Lightpipes, Stacked, 8/8, 8 Ports

[View all parts in series 44170](#)
[3D Dimensions](#)
[3D Model This Page](#)
[Samples](#)
[Buy](#)

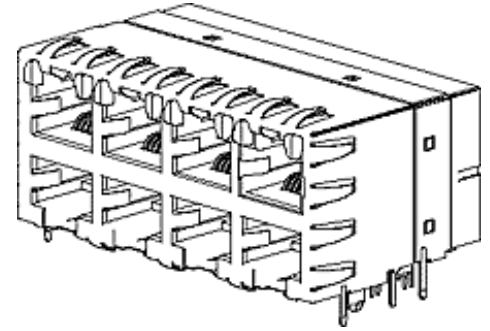

Status	Active
Access Level	Internet
Component	PCB Jack
Ports	8
Positions / Loaded Contacts	8/8
Orientation	Right Angle (Side Entry)
Inverted / Top Latch	No
Product Name	RJ45
Performance Category	5
Shielded	Yes
Lightpipes/LEDs	Lightpipes

MOUNTING

Profile	Stacked
PCB Mounting	Through Hole
Surface Mount Compatible (SMC)	No
PCB Retention	Press-fit Plastic Peg
PCB Thickness	1.6mm (.062")

PHYSICAL

Plating Contact	1.3µm (50µ") Gold (Au)
Plating Tail	2.5µm (100µ") Tin (Sn)
Under Plating	Nickel (Ni)
Packaging	Tray
Housing Material	Polyester, Glass-filled
Color	Black
Flammability	UL 94V-0
Comment	High Speed, Multi-Port
Durability [mating cycles] min.	500 cycles

ELECTRICAL

Current-max [amps]	1.5A
Voltage-max [volts]	125V
Withstanding Voltage	1000V AC
Contact Resistance [ohms]	10 milliohms max.
Insulation Resistance [ohms]	500 Megohms min.

REFERENCE

UL File Number	E107635
CSA File Number	LR14990
Mates With	FCC 68 Plugs
Temperature Range	-40°C to +80°C
MX01 Catalog Page	O-14

**This part is
ELV and RoHS
COMPLIANT**

ENVIRONMENT	
RoHS Compliant	Yes
Lead-free Process Capability Tested	No
Lead-free Process Capability	Wave Capable (TH only)

Features and Benefits

- Compact design accommodates space savings on the PCB
- Lightpipes offer lower electrical noise than LED jacks
- 100% electrically tested for hi-pot and continuity
- Exceeds Category 5 performance
- Meets Gigabit Ethernet industry standard
- Footprint meets industry standard
- Arrow-shaped lightpipes indicate activity on upper or lower port
- Lightpipes require 33% fewer PC tails than LED jacks
- Tabs on shield provide enhanced grounding to panel

990 Catalog Page	New
Product Specification	PS-44170-0003
Overview	Right Angle Modular Jacks[8603]
Circuits / Positions	8
Loaded Contacts	8
Universal Service Order Code	RJ45
Molex Series	44170
Product Management	Hirsch, Mary
Lab Office	UCP
Customer Approved	Cisco

2D DRAWING - For reference only. See technical [Drawing \(PDF\)](#) for design-in purposes.

DIMENSIONS	
Mounted Height	25.41mm (1.000")
Mounted Width	33.95mm (1.337")
Designed In	Inches
Dimension A	59.18mm (2.330")
Dimension B	8.89mm (.350")
Dimension C	53.34mm (2.100")

