

Switch Language

English

Need Assistance?

- [Contact Us](#)
- [Find a Distributor](#)
- [Order Samples](#)
- [Tech Library](#)

[Printer-friendly page](#)

[Email this page](#)

[Home](#) [PCB Headers](#) [Datasheet](#)

Part Number: 0039291088

Status: Active **Overview:** [Mini-Fit Jr.™](#)

Description: 4.20mm (.165") Pitch Mini-Fit Jr.™ Header, Dual Row, Right Angle, with PCB Mounting Flange, 8 Circuits, PA Polyamide Nylon 6/6 94V-2, Tin (Sn) Plating

Documents:

Note - Please disable browser pop-up blockers for documents on www.molex.com

- [Drawing \(PDF\)](#)
- [Product Specification PS-5557-004 \(PDF\)](#)
- [Product Specification PS-5557-021 \(PDF\)](#)
- [3D Model](#)
- [Related Catalog Page \(PDF\)](#)

Order Products:

- [Check Distributor Inventory](#)
- [Add to My Parts](#)
- [Request Samples](#)

Part Detail: [\(show all\)](#)

[General](#) [Physical](#) [Electrical](#) [Material Info](#)

General

Product Family	PCB Headers
Series	5569
Application	Wire-to-Board
Comments	10.0A max. with Mini-Fit HCS™ Terminals
Overview	Mini-Fit Jr.™
Product Name	Mini-Fit Jr.™

Physical

Breakaway	No
Circuits (Loaded)	8
Circuits (maximum)	8
Circuits Detail	8
Color - Resin	Natural
Durability (mating cycles) min	30 cycles
First Mate / Last Break	No
Flammability	94V-2
Guide to Mating Part	No
Keying to mating part	None
Lock to Mating Part	Yes
Material - Metal	Brass
Material - Plating Mating	Tin
Material - Plating Termination	Tin
Material - Resin	Nylon
Number of Rows	2
Orientation	Right Angle
PCB Locator	Yes
PCB Retention	Yes
PCB Thickness Recommended (in)	0.070 In
PCB Thickness Recommended (mm)	1.78 mm
Packaging Type	Bag
Pitch - Mating Interface (in)	0.165 In
Pitch - Mating Interface (mm)	4.20 mm

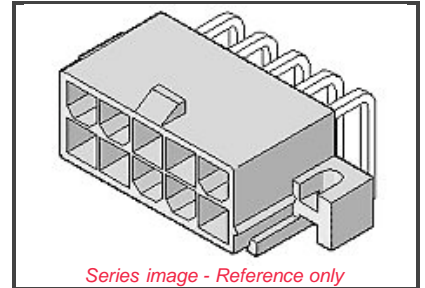

EU RoHS **China RoHS**
ELV and RoHS Compliant



Need more information on product compliance?

Email productcompliance@molex.com

Please visit the [Contact Us](#) section for any non-product compliance questions.

Search Parts in this Series

[5569 Series](#)

Mates With

[5557 Mini-Fit Jr.™ Receptacle Housing](#)

Pitch - Term. Interface (in)	0.165 In
Pitch - Term. Interface (mm)	4.20 mm
Plating min: Mating (uin)	276
Plating min: Mating (um)	7.00
Plating min: Termination (uin)	200
Plating min: Termination (um)	5.00
Polarized to Mating Part	Yes
Polarized to PCB	Yes
Robotic Placement	None
Shrouded	Fully
Stackable	No
Surface Mount Compatible (SMC)	No
Temperature Range - Operating	-40°C to +105°C
Termination Interface: Style	Through Hole

Electrical

CSA	LR19980
Current - Maximum	7.000 Amp
TUV	R75142
UL	E29179
Voltage - Maximum	600V

Material Info

Old Part Number	5569-08A1
-----------------	-----------

Reference - Drawing Numbers

Product Specification	PS-5557-004
Product Specification	PS-5557-021
Sales Drawing	SD-5569-002

注記

1. 嵌合相手: 5557 シリーズ
MATES WITH : 5557 SERIES
2. 2極の場合のみ本寸法は 4.2
IN CASE OF 2 CIRCUITS HEADER, THIS DIMENSION SHOULD BE 4.2mm.
3. 材料及びメッキ
MATERIAL & FINISH

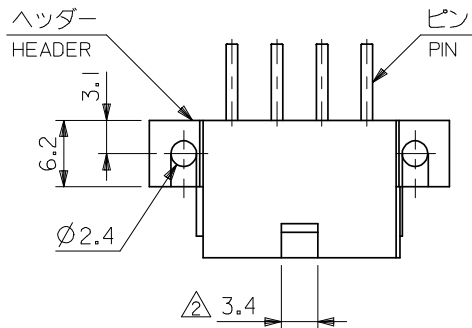

ENG. NO.	ヘッダー材料 HEADER MATERIAL	ピン材料 PIN MATERIAL	ピンのメッキ FINISH OF PIN
5569-NA1	ナイロン66, UL94V-2 NYLON 66, UL94V-2	黄銅 (□1.07)	銅下地錫メッキ TIN OVER COPPER
-NA1-210	ナイロン66, UL94V-0 NYLON 66, UL94V-0		金 : 0.76μm MIN. GOLD 0.76μm MIN. ニッケル下地 : 1.27μm MIN. OVER NICKEL 1.27μm MIN.
-NAG1	ナイロン66, UL94V-2 NYLON 66, UL94V-2		
5569-NAG1-210	ナイロン66, UL94V-0 NYLON 66, UL94V-0		

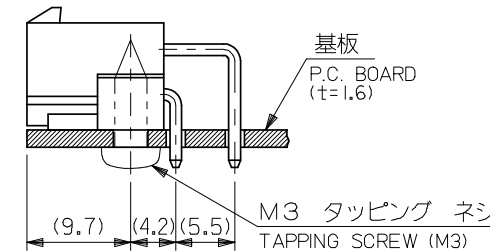
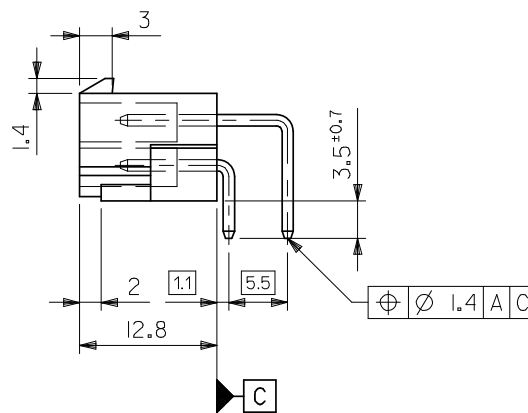
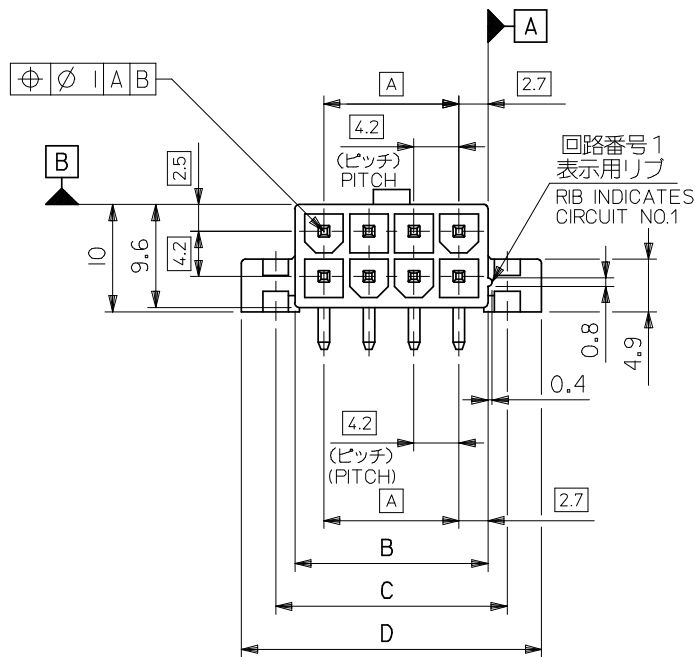

基板取付推奨寸法
RECOMMENDED INSTALLATION PATTERN

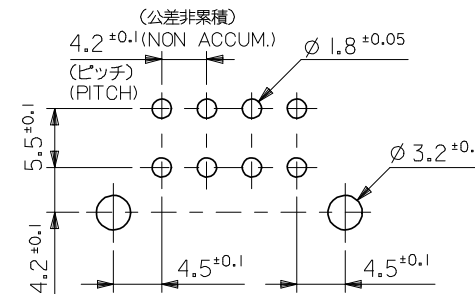

基板穴推奨寸法
RECOMMENDED P.C. BOARD PATTERN

61.6	55.2	51.6	46.2	24
57.4	51	47.4	42	22
53.2	46.8	43.2	37.8	20
49	42.6	39	33.6	18
44.8	38.4	34.8	29.4	16
40.6	34.2	30.6	25.2	14
36.4	30	26.4	21	12
32.2	25.8	22.2	16.8	10
28	21.6	18	12.6	8
23.8	17.4	13.8	8.4	6
19.6	13.2	9.6	4.2	4
15.4	9	5.4	—	2
D	C	B	A	極数 CIRCUIT

REVISED EC NO: J2008-3781 DRWN:WABEI 2008/05/12 CHKD:MISOGAYA 2008/05/12 APPR:NUKITA 2008/05/12	DESCRIPTION	GENERAL TOLERANCES (UNLESS SPECIFIED)		DIMENSION STYLE MM ONLY		SCALE 2:1	DESIGN UNITS METRIC	THIRD ANGLE PROJECTION	
		10 UNDER	±0.2	DRAWN BY H.HIRAMOTO	DATE '90/04/23	TITLE NEW MINI FIT CONN R/A HEADER ASSY WITH FLANGE		molex MOLEX INCORPORATED	
10 OVER 30 UNDER	±0.3	CHECKED BY M.FUKUSHIMA	DATE '91/07/04	MATERIAL NO. SEE TABLE		DOCUMENT NO. SD-5569-002	SHEET NO. 1 OF 2		
30 OVER	±0.4	APPROVED BY M.ENOMOTO '91/07/04		SIZE A3		THIS DRAWING CONTAINS INFORMATION THAT IS PROPRIETARY TO MOLEX INCORPORATED AND SHOULD NOT BE USED WITHOUT WRITTEN PERMISSION			
ANGULAR ±3°		DRAFT WHERE APPLICABLE MUST REMAIN WITHIN DIMENSIONS							

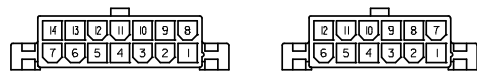

14極
14 CKTS.

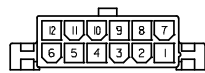

12極
12 CKTS.

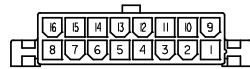

16極
16 CKTS.

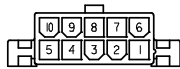

10極
10 CKTS.

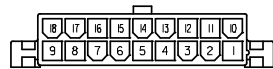

18極
18 CKTS.

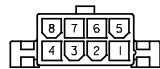

8極
8 CKTS.

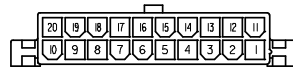

20極
20 CKTS.

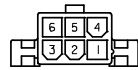

6極
6 CKTS.

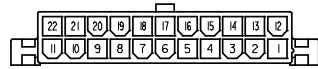

22極
22 CKTS.

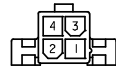

4極
4 CKTS.

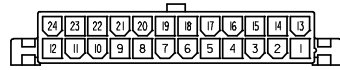

24極
24 CKTS.



2極
2 CKTS.

極数別レイアウト図
CIRCUIT SIZE LAYOUT
(SCALE 1:1)

39-29-4249	5569-24AG1-210	39-29-1247	5569-24A1-210	24
▲ -4229	▲ -22AG1-210	▲ -1227	▲ -22A1-210	22
-4209	-20AG1-210	-1207	-20A1-210	20
-4189	-18AG1-210	-1187	-18A1-210	18
-4169	-16AG1-210	-1167	-16A1-210	16
-4149	-14AG1-210	-1147	-14A1-210	14
-4129	-12AG1-210	-1127	-12A1-210	12
-4109	-10AG1-210	-1107	-10A1-210	10
-4089	-08AG1-210	-1087	-08A1-210	8
-4069	-06AG1-210	-1067	-06A1-210	6
▼ -4049	▼ -04AG1-210	▼ -1047	▼ -04A1-210	4
39-29-4029	5569-02AG1-210	39-29-1027	5569-02A1-210	2
EDP NO.	ENG. NO.	EDP NO.	ENG. NO.	極数
5569-NAG1-210		5569-NA1-210		CIRCUIT
39-29-5243	5569-24AG1	39-29-1248	5569-24A1	24
▲ -5223	▲ -22AG1	▲ -1228	▲ -22A1	22
-5203	-20AG1	-1208	-20A1	20
-5183	-18AG1	-1188	-18A1	18
-5163	-16AG1	-1168	-16A1	16
-5143	-14AG1	-1148	-14A1	14
-5123	-12AG1	-1128	-12A1	12
-5103	-10AG1	-1108	-10A1	10
-5083	-08AG1	-1088	-08A1	8
-5063	-06AG1	-1068	-06A1	6
▼ -5043	▼ -04AG1	▼ -1048	▼ -04A1	4
39-29-5023	5569-02AG1	39-29-1028	5569-02A1	2
EDP NO.	ENG. NO.	EDP NO.	ENG. NO.	極数
5569-NAG1		5569-NA1		CIRCUIT

REVISED EC NO: J2008-3781 DRWN:WABEI 2008/05/12 CHKD:MISOGAYA 2008/05/12 APPR:NUKITA 2008/05/12	GENERAL TOLERANCES (UNLESS SPECIFIED)		DIMENSION STYLE MM ONLY	SCALE 2:1	DESIGN UNITS METRIC	THIRD ANGLE PROJECTION
	10 UNDER	±0.2	DRAWN BY H.HIRAMOTO	DATE '90/04/23	NEW MINI FIT CONN R/A HEADER ASSY WITH FLANGE	
	10 OVER 30 UNDER	±0.3	CHECKED BY M.FUKUSHIMA	DATE '91/07/04		
	30 OVER	±0.4	APPROVED BY M.ENOMOTO	DATE '91/07/04	MOLEX INCORPORATED	
	ANGULAR	±3 °	MATERIAL NO.	DOCUMENT NO.	SHEET NO. 2 OF 2	
DRAFT WHERE APPLICABLE MUST REMAIN WITHIN DIMENSIONS		SEE TABLE		SD-5569-002		
J	THIS DRAWING CONTAINS INFORMATION THAT IS PROPRIETARY TO MOLEX INCORPORATED AND SHOULD NOT BE USED WITHOUT WRITTEN PERMISSION					