

Switch Language

English

Need Assistance?

Contact Us  
Find a Distributor  
Order Samples  
Tech Library

Printer-friendly page

Email this page

[Home](#) [PCB Headers](#) [Datasheet](#)

**Part Number:** 0039291068

**Status:** Active **Overview:** [Mini-Fit Jr.™](#)

**Description:** 4.20mm (.165") Pitch Mini-Fit Jr.™ Header, Dual Row, Right Angle, with PCB Mounting Flange, 6 Circuits, PA Polyamide Nylon 6/6 94V-2, Tin (Sn) Plating

**Documents:**

Note - Please disable browser pop-up blockers for documents on [www.molex.com](http://www.molex.com)

- [Drawing \(PDF\)](#)
- [Product Specification PS-5557-004 \(PDF\)](#)
- [Product Specification PS-5557-021 \(PDF\)](#)
- [3D Model](#)
- [Related Catalog Page \(PDF\)](#)

**Order Products:**

[Check Distributor Inventory](#) [Add to My Parts](#)  
[Request Samples](#)

**Part Detail:** [\(show all\)](#)

[General](#) [Physical](#) [Electrical](#) [Material Info](#)

**General**

Product Family	PCB Headers
Series	<a href="#">5569</a>
Application	Wire-to-Board
Comments	11.0A max. with Mini-Fit HCS™ Terminals
Overview	<a href="#">Mini-Fit Jr.™</a>
Product Name	Mini-Fit Jr.™

**Physical**

Breakaway	No
Circuits (Loaded)	6
Circuits (maximum)	6
Circuits Detail	6
Color - Resin	Natural
Durability (mating cycles) min	30 cycles
First Mate / Last Break	No
Flammability	94V-2
Guide to Mating Part	No
Keying to mating part	None
Lock to Mating Part	Yes
Material - Metal	Brass
Material - Plating Mating	Tin
Material - Plating Termination	Tin
Material - Resin	Nylon
Number of Rows	2
Orientation	Right Angle
PCB Locator	Yes
PCB Retention	Yes
PCB Thickness Recommended (in)	0.070 In
PCB Thickness Recommended (mm)	1.78 mm
Packaging Type	Bag
Pitch - Mating Interface (in)	0.165 In
Pitch - Mating Interface (mm)	4.20 mm

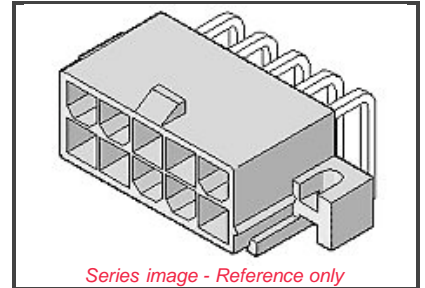

Series image - Reference only

**EU RoHS** **China RoHS**  
**ELV and RoHS Compliant**



**Need more information on product compliance?**

Email [productcompliance@molex.com](mailto:productcompliance@molex.com)

Please visit the [Contact Us](#) section for any non-product compliance questions.

**Search Parts in this Series**

[5569](#) Series

**Mates With**

[5557](#) Mini-Fit Jr.™ Receptacle Housing

Pitch - Term. Interface (in)	0.165 In
Pitch - Term. Interface (mm)	4.20 mm
Plating min: Mating (uin)	276
Plating min: Mating (um)	7.00
Plating min: Termination (uin)	200
Plating min: Termination (um)	5.00
Polarized to Mating Part	Yes
Polarized to PCB	Yes
Robotic Placement	None
Shrouded	Fully
Stackable	No
Surface Mount Compatible (SMC)	No
Temperature Range - Operating	-40°C to +105°C
Termination Interface: Style	Through Hole

**Electrical**

CSA	LR19980
Current - Maximum	8.000 Amp
TUV	R75142
UL	E29179
Voltage - Maximum	600V

**Material Info**

Old Part Number	5569-06A1
-----------------	-----------

**Reference - Drawing Numbers**

Product Specification	PS-5557-004
Product Specification	PS-5557-021
Sales Drawing	SD-5569-002

注記

1. 嵌合相手: 5557 シリーズ  
MATES WITH : 5557 SERIES
2. 2極の場合のみ本寸法は 4.2  
IN CASE OF 2 CIRCUITS HEADER, THIS DIMENSION SHOULD BE 4.2mm.
3. 材料及びメッキ  
MATERIAL & FINISH

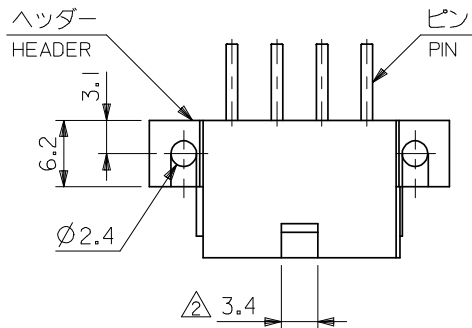

ENG. NO.	ヘッダー材料 HEADER MATERIAL	ピン材料 PIN MATERIAL	ピンのメッキ FINISH OF PIN
5569-NA1	ナイロン66, UL94V-2 NYLON 66, UL94V-2	黄銅 (□1.07)	銅下地錫メッキ TIN OVER COPPER
-NA1-210	ナイロン66, UL94V-0 NYLON 66, UL94V-0		
-NAG1	ナイロン66, UL94V-2 NYLON 66, UL94V-2	BRASS (1.07 SQUARE)	金 : 0.76μm MIN. GOLD 0.76μm MIN.
5569-NAG1-210	ナイロン66, UL94V-0 NYLON 66, UL94V-0		ニッケル下地 : 1.27μm MIN. OVER NICKEL 1.27μm MIN.

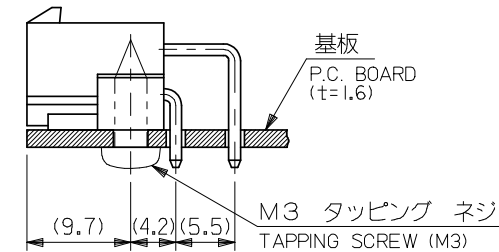
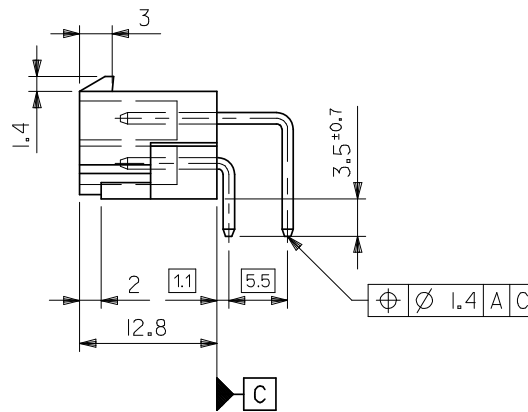
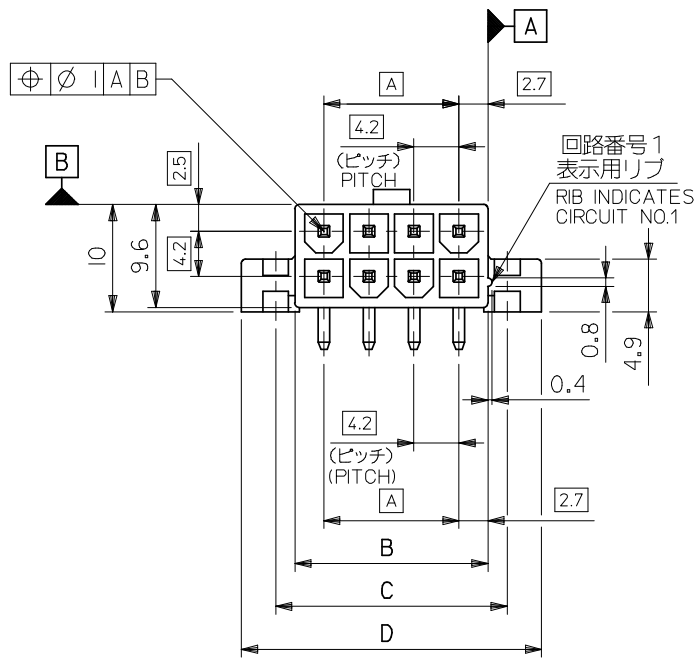

基板取付推奨寸法  
RECOMMENDED INSTALLATION PATTERN

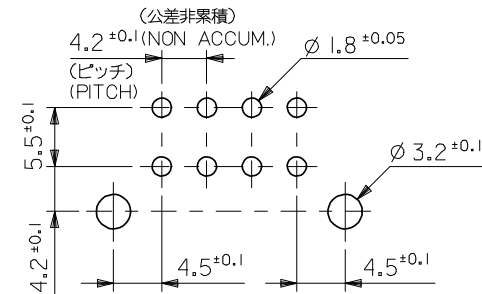

基板穴推奨寸法  
RECOMMENDED P.C. BOARD PATTERN

61.6	55.2	51.6	46.2	24
57.4	51	47.4	42	22
53.2	46.8	43.2	37.8	20
49	42.6	39	33.6	18
44.8	38.4	34.8	29.4	16
40.6	34.2	30.6	25.2	14
36.4	30	26.4	21	12
32.2	25.8	22.2	16.8	10
28	21.6	18	12.6	8
23.8	17.4	13.8	8.4	6
19.6	13.2	9.6	4.2	4
15.4	9	5.4	—	2

極数  
CIRCUIT

GENERAL TOLERANCES (UNLESS SPECIFIED)		DIMENSION STYLE MM ONLY		SCALE 2:1	DESIGN UNITS METRIC	THIRD ANGLE PROJECTION	
10 UNDER	±0.2	DRAWN BY H. HIRAMOTO	DATE '90/04/23	NEW MINI FIT CONN R/A HEADER ASSY WITH FLANGE  MOLEX INCORPORATED SD-5569-002			
10 OVER 30 UNDER	±0.3	CHECKED BY M. FUKUSHIMA	DATE '91/07/04				
30 OVER	±0.4	APPROVED BY M. ENOMOTO	DATE '91/07/04				
ANGULAR	±3 °	MATERIAL NO.	DOCUMENT NO.				
DRAFT WHERE APPLICABLE MUST REMAIN WITHIN DIMENSIONS		SEE TABLE		SHEET NO. 1 OF 2			
THIS DRAWING CONTAINS INFORMATION THAT IS PROPRIETARY TO MOLEX INCORPORATED AND SHOULD NOT BE USED WITHOUT WRITTEN PERMISSION							

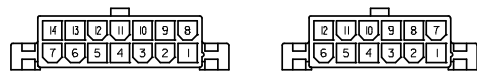

14極  
14 CKTS.

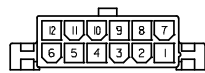

12極  
12 CKTS.

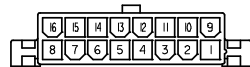

16極  
16 CKTS.

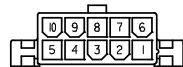

10極  
10 CKTS.

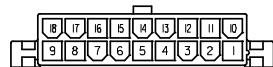

18極  
18 CKTS.

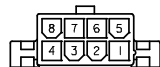

8極  
8 CKTS.

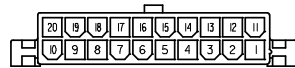

20極  
20 CKTS.

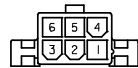

6極  
6 CKTS.

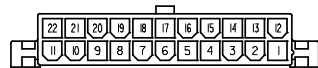

22極  
22 CKTS.

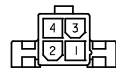

4極  
4 CKTS.

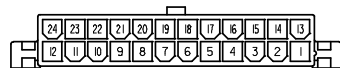

24極  
24 CKTS.



2極  
2 CKTS.

極数別レイアウト図  
CIRCUIT SIZE LAYOUT  
(SCALE 1:1)

39-29-4249	5569-24AG1-210	39-29-1247	5569-24A1-210	24
▲ -4229	▲ -22AG1-210	▲ -1227	▲ -22A1-210	22
-4209	-20AG1-210	-1207	-20A1-210	20
-4189	-18AG1-210	-1187	-18A1-210	18
-4169	-16AG1-210	-1167	-16A1-210	16
-4149	-14AG1-210	-1147	-14A1-210	14
-4129	-12AG1-210	-1127	-12A1-210	12
-4109	-10AG1-210	-1107	-10A1-210	10
-4089	-08AG1-210	-1087	-08A1-210	8
-4069	-06AG1-210	-1067	-06A1-210	6
▼ -4049	▼ -04AG1-210	▼ -1047	▼ -04A1-210	4
39-29-4029	5569-02AG1-210	39-29-1027	5569-02A1-210	2
EDP NO.	ENG. NO.	EDP NO.	ENG. NO.	極数
5569-NAG1-210		5569-NA1-210		CIRCUIT
39-29-5243	5569-24AG1	39-29-1248	5569-24A1	24
▲ -5223	▲ -22AG1	▲ -1228	▲ -22A1	22
-5203	-20AG1	-1208	-20A1	20
-5183	-18AG1	-1188	-18A1	18
-5163	-16AG1	-1168	-16A1	16
-5143	-14AG1	-1148	-14A1	14
-5123	-12AG1	-1128	-12A1	12
-5103	-10AG1	-1108	-10A1	10
-5083	-08AG1	-1088	-08A1	8
-5063	-06AG1	-1068	-06A1	6
▼ -5043	▼ -04AG1	▼ -1048	▼ -04A1	4
39-29-5023	5569-02AG1	39-29-1028	5569-02A1	2
EDP NO.	ENG. NO.	EDP NO.	ENG. NO.	極数
5569-NAG1		5569-NA1		CIRCUIT

REVISED EC NO: J2008-3781 DRWN: NABEI 2008/05/12 CHKD: MISOGAYA 2008/05/12 APPR: NUKITA 2008/05/12	GENERAL TOLERANCES (UNLESS SPECIFIED)		DIMENSION STYLE	SCALE	DESIGN UNITS	THIRD ANGLE PROJECTION
			MM ONLY	2:1	METRIC	
	10 UNDER	±0.2	DRAWN BY	DATE	NEW MINI FIT CONN R/A HEADER ASSY WITH FLANGE	
	10 OVER 30 UNDER	±0.3	H.HIRAMOTO	'90/04/23		
	30 OVER	±0.4	CHECKED BY	DATE	MOLEX INCORPORATED DOCUMENT NO. SD-5569-002	
ANGULAR ±3 °		M. FUKUSHIMA	'91/07/04			
DRAFT WHERE APPLICABLE MUST REMAIN WITHIN DIMENSIONS		APPROVED BY	DATE	SHEET NO.		
		M. ENOMOTO	'91/07/04	2 OF 2		
		MATERIAL NO. SEE TABLE		THIS DRAWING CONTAINS INFORMATION THAT IS PROPRIETARY TO MOLEX INCORPORATED AND SHOULD NOT BE USED WITHOUT WRITTEN PERMISSION		