

Switch Language

English

Need Assistance?

Contact Us  
Find a Distributor  
Order Samples  
Tech Library

Printer-friendly page

Email this page

[Home](#)   [Crimp Housings](#)   [Datasheet](#)

**Part Number:** 0039012065

**Status:** Active    **Overview:** [Mini-Fit Jr.™](#)

**Description:** 4.20mm (.165") Pitch Mini-Fit Jr.™ Receptacle Housing, Dual Row, UL 94V-0, 6 Circuits

**Documents:**

*Note - Please disable browser pop-up blockers for documents on www.molex.com*

[Drawing \(PDF\)](#)

[3D Model](#)

[Test Summary \(PDF\)](#)

[Related Catalog Page \(PDF\)](#)

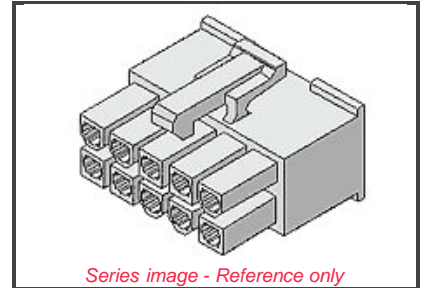

**Order Products:**

[Check Distributor Inventory](#)

[Add to My Parts](#)

[Request Samples](#)

**Part Detail:** ([show all](#))

[General](#)   [Physical](#)   [Electrical](#)   [Material Info](#)

**General**

Product Family	Crimp Housings
Series	<a href="#">5557</a>
Comments	Use with Strain Relief 41995 series
Overview	<a href="#">Mini-Fit Jr.™</a>
Product Name	Mini-Fit Jr.™

**Physical**

Breakaway	No
Circuits (maximum)	6
Color - Resin	Ivory
Flammability	94V-0
Flammability	94V-2
Gender	Female
Material - Resin	Nylon
Number of Rows	2
Packaging Type	Bag
Panel Mount	No
Pitch - Mating Interface (in)	0.165 In
Pitch - Mating Interface (mm)	4.20 mm
Pitch - Term. Interface (in)	0.165 In
Pitch - Term. Interface (mm)	4.20 mm
Polarized to Mating Part	Yes
Stackable	No
Temperature Range - Operating	-40°C to +105°C

**Electrical**

CSA	LR19980
TUV	R75142
UL	E29179

**Material Info**

Old Part Number	5557-06R-210
-----------------	--------------

**EU RoHS**

**ELV and RoHS Compliant**

**China RoHS**



**Need more information on product compliance?**

Email [productcompliance@molex.com](mailto:productcompliance@molex.com)

Please visit the [Contact Us](#) section for any non-product compliance questions.

**Search Parts in this Series**

[5557](#) Series

**Mates With**

[5559d](#), [5566vw](#), [5566vwo](#), [5569rdf](#),  
[5569rdp](#), [43810a](#), [43810b](#), [43810c](#),  
[43810d](#), [44068a](#), [44068b](#), [44068c](#),  
[44068d](#), [44281](#), [44472dw](#), [44472dwo](#),  
[87427](#), [87427r](#), [87427rf](#), [42404](#),  
[44474](#), [42440](#), [43879](#), [42475](#)

**Use With**

[41995](#) Strain Relief

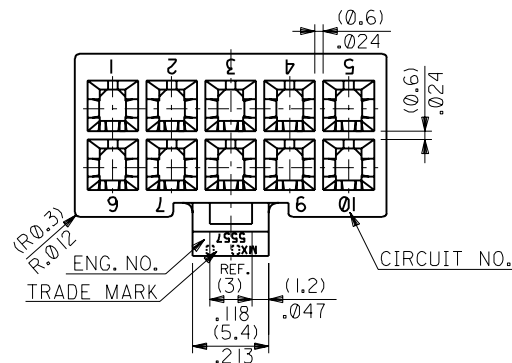

**NOTES**

1. TERMINAL : 5556 SERIES
2. MATE WITH : 5559 SERIES  
5566 SERIES  
5569 SERIES
3. (METRIC) VALUES SHOWN GOVERN OVER ENGLISH CONVERSION VALUES.  
▲ TO BE MEASURED AT POSITION OF □ SURFACE.

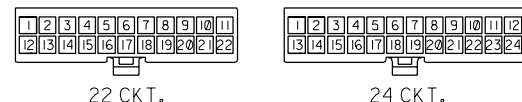
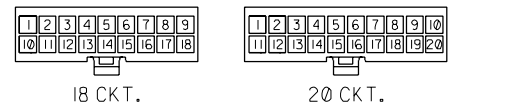
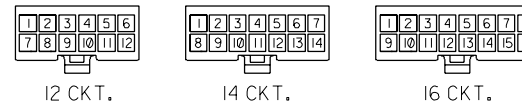
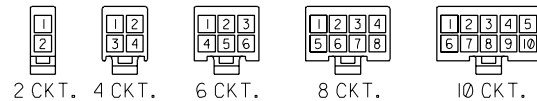

**CIRCUIT SIZE LAYOUT**  
(SCALE: 1-1)

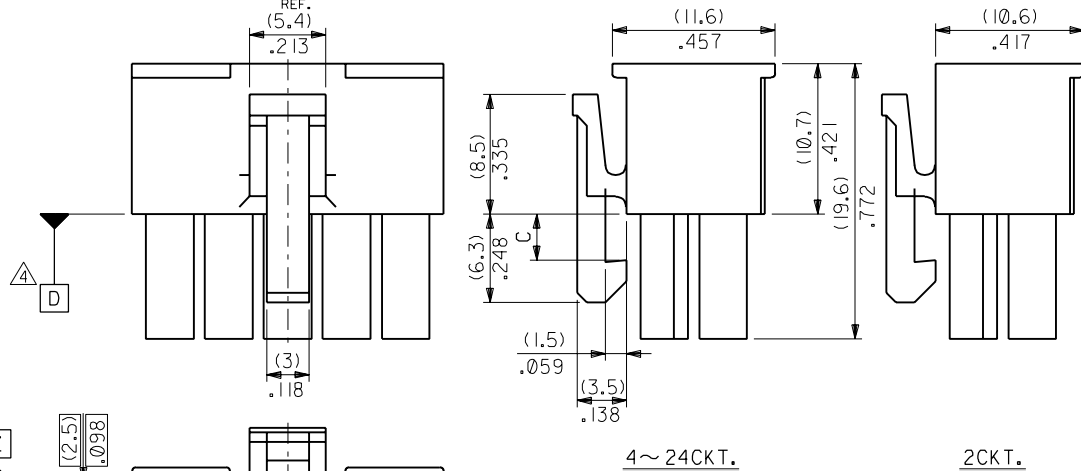

4~24CKT.

2CKT.

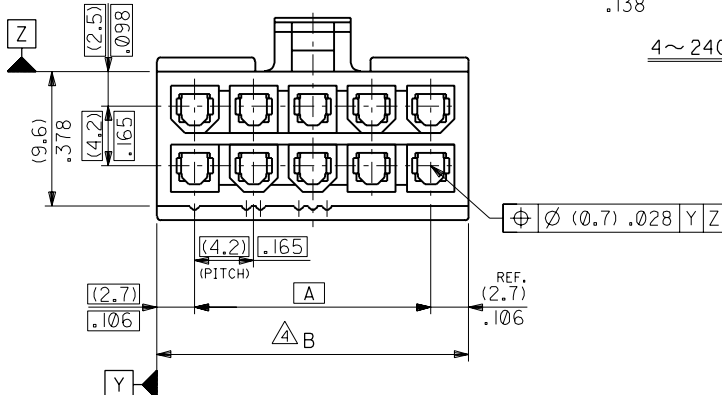

(3,6) .142	(51.6)	2.031	(46.2)	1.819	39-01-2245	5557-24R-210	24
	(47.4)	1.866	(42)	1.654	▲ -2225	▲ -22R-210	22
(3,3) .129	(43.2)	1.701	(37.8)	1.488	-2205	-20R-210	20
	(39)	1.535	(33.6)	1.323	-2185	-18R-210	18
	(34.8)	1.37	(29.4)	1.158	-2165	-16R-210	16
	(30.6)	1.205	(25.2)	.992	-2145	-14R-210	14
	(26.4)	1.039	(21)	.827	-2125	-12R-210	12
	(22.2)	.874	(16.8)	.661	-2105	-10R-210	10
	(18)	.709	(12.6)	.496	-2085	-08R-210	8
	(13.8)	.543	(8.4)	.331	-2065	-06R-210	6
C	(9.6)	.378	(4.2)	.165	▼ -2045	▼ -04R-210	4
	(5.4)	.213	—	—	39-01-2025	5557-02R-210	2
					EDP. NO.	ENG. NO.	NO. OF CKTS.

材料 MATERIAL		66NYLON (UL94V-0)	
F REVISIED (JC70586)		S.A	/91/11/8
E REVISIED (J20158)		H.H	/92/4/20
D REVISIED (J01160)		H.H	/90/11/8
C REVISIED & REDRAWN (J00192)		S.M	/90/2/22
記号 LTR 変更内容 REVISION RECORD		DR. CHK.	日付 DATE
一般公差 GENERAL TOLERANCES		REVISE ONLY ON CAD SYSTEM	

MATERIAL FINISH		—	
適用電線範囲 WIRE RANGE		—	
被覆外径 INS. RANGE		—	
DRAWN BY '90/2/22		CHK'D BY '91/01/08	
S. MOCHIZUKI		M. FUKUSHIMA	
APP'D BY '91/01/08		M. FUKUSHIMA	
M. FUKUSHIMA		尺度 SCALE 3 - 1	
MOLEX JAPAN CO., LTD. 日本モレックス株式会社			
EDP. NO. 39-01-2**5			
ENG. NO. SD-5557-NR-210			
TITLE 名称 NEW MINI FIT CONN. REC. HOUSING			