

Switch Language

English

Need Assistance?

- Contact Us
- Find a Distributor
- Order Samples
- Tech Library

Printer-friendly page

Email this page

[Home](#) [Datasheet](#)

Part Number: 0380090283

Status: Active - Custom

Description: STRIP MARKER 20 STD

Documents:

Note - Please disable browser pop-up blockers for documents on www.molex.com

[Drawing \(PDF\)](#)

Order Products:

[Check Distributor Inventory](#) [Add to My Parts](#)

Part Detail: [\(show all\)](#)

Material Info

Product Family	Molex Parts
Series	38009
Material Info	
Old Part Number	VF-18020-101



EU RoHS

ELV and RoHS Compliant

China RoHS



Need more information on product compliance?

Email productcompliance@molex.com

Please visit the [Contact Us](#) section for any non-product compliance questions.

Search Parts in this Series

[38009](#) Series

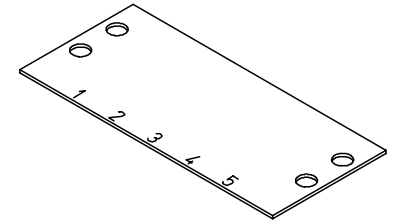
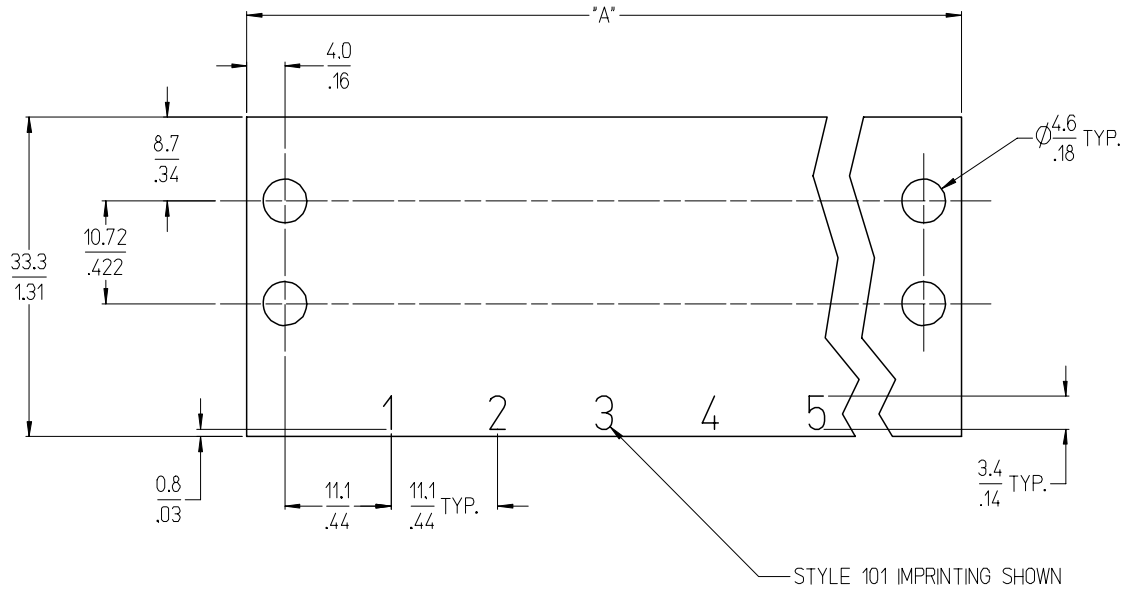

STRIP FOR 5 CIRCUIT ASSEMBLY SHOWN AT FULL SCALE

NOTES:

1. MATERIAL: BLACK VULCANIZED FIBRE, .031" THICK
2. PART IS ROHS COMPLIANT.
3. IMPRINTING TEXT LOCATIONS AND HEIGHT ARE TYPICAL AS SHOWN.
4. STYLES 101 THROUGH 204, REFER TO SD-38120-008.
5. STYLE 000 IS UNMARKED.

INITIAL RELEASE EC NO: ETC2007-0021 DRWN: CYORK 2006/08/01 CHKD: RDEROSS 2006/08/07 APPR: RDEROSS 2006/08/08	DESCRIPTION A	QUALITY SYMBOLS	GENERAL TOLERANCES (UNLESS SPECIFIED)	DIMENSION STYLE	SCALE	DESIGN UNITS	THIRD ANGLE PROJECTION															
		▼=0 ▽=0	<table border="1"> <thead> <tr> <th></th> <th>mm</th> <th>INCH</th> </tr> </thead> <tbody> <tr> <td>4 PLACES</td> <td>± ---</td> <td>± ---</td> </tr> <tr> <td>3 PLACES</td> <td>± ---</td> <td>± .006</td> </tr> <tr> <td>2 PLACES</td> <td>± 0.15</td> <td>± .02</td> </tr> <tr> <td>1 PLACE</td> <td>± 0.5</td> <td>± ---</td> </tr> </tbody> </table>		mm	INCH	4 PLACES	± ---	± ---	3 PLACES	± ---	± .006	2 PLACES	± 0.15	± .02	1 PLACE	± 0.5	± ---	MM/IN	2:1	INCH	
			mm	INCH																		
		4 PLACES	± ---	± ---																		
3 PLACES	± ---	± .006																				
2 PLACES	± 0.15	± .02																				
1 PLACE	± 0.5	± ---																				
	DRAWN BY: C. YORK DATE: 2006/07/25 CHECKED BY: R. DEROSS DATE: 2006/07/25 APPROVED BY: R. DEROSS DATE: 2006/07/25	TITLE: STRIP, MARKER, DUAL ROW																				
	MATERIAL NO.: SEE SHEET 2 DOCUMENT NO.: SD-38009-001 SHEET NO.: 1 OF 2	MOLEX INCORPORATED THIS DRAWING CONTAINS INFORMATION THAT IS PROPRIETARY TO MOLEX INCORPORATED AND SHOULD NOT BE USED WITHOUT WRITTEN PERMISSION																				

NO. OF CIRCUITS	DIM. "A"		MATERIAL NO. (STYLE 000)	MATERIAL NO. (IMPRINTED STYLE 101)	MATERIAL NO. (IMPRINTED STYLE 201)
	mm	in			
01	30.2	1.19	380090240	380090239	
02	41.3	1.63	380090616	380090241	380090304
03	52.4	2.06	380090244	380090242	
04	63.5	2.50	380090246	380090245	380090310
05	74.6	2.94	380090248	380090247	
06	85.7	3.38	380090251	380090249	380090314
07	96.8	3.81	380090253	380090252	
08	108.0	4.25	380090256	380090254	380090322
09	119.1	4.69	380090259	380090257	
10	130.2	5.13	380090261	380090260	380090332
11	141.3	5.56	380090264	380090262	
12	152.4	6.00	380090267	380090265	380090341
13	163.5	6.44	380090269	380090268	
14	174.6	6.88	380090271	380090270	380090344
15	185.7	7.31	380090274	380090272	
16	196.9	7.75	380090276	380090275	380090346
17	208.0	8.19	380090278	380090277	
18	219.1	8.63	380090281	380090279	
19	230.2	9.06	380090282	380090615	
20	241.3	9.50	380090285	380090283	
21	252.4	9.94	380090287	380090286	
22	263.5	10.38	380090289	380090288	
23	274.6	10.81	380090290		
24	285.8	11.25	380090293	380090291	
25	296.9	11.69	380090295	380090294	
26	308.0	12.13	380090297	380090296	
27	319.1	12.56	380090298		
28	330.2	13.00	380090300	380090299	
29	341.3	13.44	380090301		
30	352.4	13.88	380090303	380090302	

SEE SHEET 1 EC NO: ETC2007-0021 DRWN: CYORK 2006/08/01 CHKD: RDEROSS 2006/08/07 APPR: RDEROSS 2006/08/08	DESCRIPTION A	QUALITY SYMBOLS ▽=0 ▽=0	GENERAL TOLERANCES (UNLESS SPECIFIED) <table border="1"> <tr> <th></th> <th>mm</th> <th>INCH</th> </tr> <tr> <td>4 PLACES</td> <td>± ---</td> <td>± ---</td> </tr> <tr> <td>3 PLACES</td> <td>± ---</td> <td>± .006</td> </tr> <tr> <td>2 PLACES</td> <td>± 0.15</td> <td>± .02</td> </tr> <tr> <td>1 PLACE</td> <td>± 0.5</td> <td>± ---</td> </tr> </table>		mm	INCH	4 PLACES	± ---	± ---	3 PLACES	± ---	± .006	2 PLACES	± 0.15	± .02	1 PLACE	± 0.5	± ---	DIMENSION STYLE MM/IN DRAWN BY C. YORK DATE 2006/07/25 CHECKED BY R. DEROSS DATE 2006/07/25 APPROVED BY R. DEROSS DATE 2006/07/25	SCALE --- DESIGN UNITS INCH THIRD ANGLE PROJECTION	TITLE STRIP, MARKER, DUAL ROW
			mm	INCH																	
		4 PLACES	± ---	± ---																	
		3 PLACES	± ---	± .006																	
2 PLACES	± 0.15	± .02																			
1 PLACE	± 0.5	± ---																			
DRAFT WHERE APPLICABLE MUST REMAIN WITHIN DIMENSIONS	MATERIAL NO. SEE CHART	DOCUMENT NO. SD-38009-001	SHEET NO. 2 OF 2																		
THIS DRAWING CONTAINS INFORMATION THAT IS PROPRIETARY TO MOLEX INCORPORATED AND SHOULD NOT BE USED WITHOUT WRITTEN PERMISSION																					

13 12 11 10 9 8 7 6 5 4 3 2 1

J

I

H

G

F

E

D

C

B

A

J

I

H

G

F

E

D

C

B

A

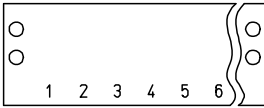

STYLE 101

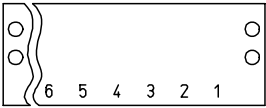

STYLE 102

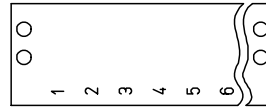

STYLE 103

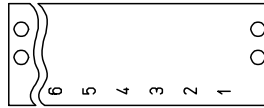

STYLE 104

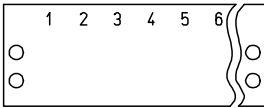

STYLE 201

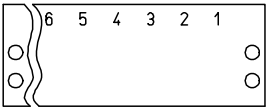

STYLE 202

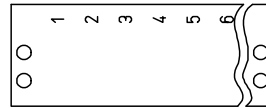

STYLE 203

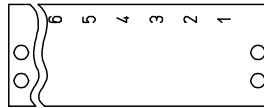

STYLE 204

- NOTES:
1. STYLE 101 IS STANDARD IMPRINTING FOR MARKER STRIPS WITHOUT FEED-THRU.
 2. REFER TO SPECIFIC PRODUCT DRAWING FOR IMPRINTING TEXT HEIGHT AND LOCATION.
 3. ALL COMPONENTS ARE ROHS COMPLIANT.

INITIAL RELEASE EC NO: ETC2007-0021 DRAWN BY: C. YORK CHKD: R. DEROSS APPR: R. DEROSS	2006/08/07	DATE
	2006/08/07	DATE
	2006/08/08	DATE
	2006/08/08	DATE
REV	DESCRIPTION	
A		

QUALITY SYMBOLS

GENERAL TOLERANCES (UNLESS SPECIFIED)	
	mm
4 PLACES	± .005
3 PLACES	± .01
2 PLACES	± 0.13
1 PLACE	± 0.3
ANGULAR ± 2 °	

DRAFT WHERE APPLICABLE MUST REMAIN WITHIN DIMENSIONS

DIMENSION STYLE INCH ONLY	
DRAWN BY	C. YORK
DATE	2006/07/25
CHECKED BY	R. DEROSS
DATE	2006/07/25
APPROVED BY	R. DEROSS
DATE	2006/07/25
MATERIAL NO.	---

SCALE	---
DESIGN UNITS	INCH
THIRD ANGLE PROJECTION	
TITLE MARKER STRIP IMPRINTING FOR NON-FEED-THRU, STYLES 1YY AND 2YY	
MOLEX INCORPORATED	
DOCUMENT NO.	SD-38120-008
SHEET NO.	1 OF 1

THIS DRAWING CONTAINS INFORMATION THAT IS PROPRIETARY TO MOLEX INCORPORATED AND SHOULD NOT BE USED WITHOUT WRITTEN PERMISSION

12 11 10 9 8 7 6 5 4 3 2 1