

Switch Language

English

Need Assistance?

- [Contact Us](#)
- [Find a Distributor](#)
- [Order Samples](#)
- [Tech Library](#)

[Printer-friendly page](#)

[Email this page](#)

[Home](#) [PCB Headers](#) [Datasheet](#)

Part Number: 0026481066

Status: Active

Description: 3.96mm (.156") Pitch KK® Header, Breakaway, Right Angle, with Friction Lock, 6 Circuits, Tin (Sn) Plating

Documents:

Note - Please disable browser pop-up blockers for documents on www.molex.com

- [Drawing \(PDF\)](#)
- [Product Specification PS-08-50 \(PDF\)](#)
- [3D Model](#)
- [Packaging Specification \(PDF\)](#)
- [Related Catalog Page \(PDF\)](#)

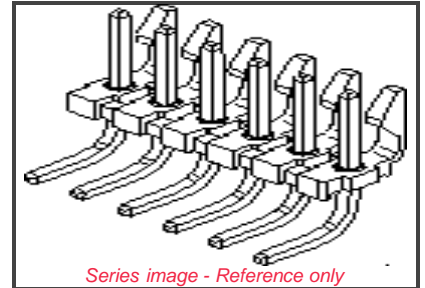

Order Products:

- [Check Distributor Inventory](#)
- [Add to My Parts](#)
- [Request Samples](#)

Part Detail: (show all)

[General](#) [Physical](#) [Electrical](#) [Material Info](#)

General

Product Family	PCB Headers
Series	41672
Application	Wire-to-Board
Product Name	KK®

Physical

Breakaway	Yes
Circuits (Loaded)	6
Circuits (maximum)	6
Color - Resin	Black
Durability (mating cycles) min	25 cycles
Flammability	94V-0
Lock to Mating Part	Yes
Material - Metal	Brass
Material - Plating Mating	Tin
Material - Plating Termination	Tin
Material - Resin	Polyester
Number of Rows	1
Orientation	Right Angle
PC Tail Length (in)	0.212 In
PC Tail Length (mm)	5.38 mm
PCB Locator	No
PCB Retention	None
PCB Thickness Recommended (in)	0.062 In
PCB Thickness Recommended (mm)	1.60 mm
Packaging Type	Bag
Pitch - Mating Interface (in)	0.156 In
Pitch - Mating Interface (mm)	3.96 mm
Plating min: Mating (uin)	200
Plating min: Mating (um)	5
Plating min: Termination (uin)	200
Plating min: Termination (um)	5
Polarized to Mating Part	No
Polarized to PCB	Yes

EU RoHS
ELV and RoHS Compliant

China RoHS



Need more information on product compliance?

Email productcompliance@molex.com

Please visit the [Contact Us](#) section for any non-product compliance questions.

Duration at Max. Process Temperature (seconds)	5
Lead-free Process Capability	Wave Capable (TH only)
Max. Cycles at Max. Process Temperature	1
Process Temperature max. C	235

Search Parts in this Series

[41672 Series](#)

Mates With

[3069](#), [3215](#), [2139](#), [2145](#), [6442](#), [7674](#), [7675](#), [41695](#), [41815](#)

Shrouded	No
Stackable	No
Temperature Range - Operating	0°C to +75°C
Termination Interface: Style	Through Hole

Electrical

CSA	LR19980
Current - Maximum	7.000 Amp
UL	E29179
Voltage - Maximum	250V

Material Info

Old Part Number	A-41672-A06A102
-----------------	-----------------

Reference - Drawing Numbers

Product Specification	PS-08-50
Sales Drawing	SD-41672-001
Sales Drawing	SD-41672-002

6

5

4

3

2

1

CENTERLINE OF PIN IN AREA SHOWN NOT TO VARY FROM CENTERLINE OF PIN AT -D- BY MORE THAN 0.13/.005 IN ANY DIRECTION.

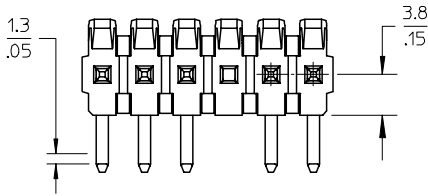

A-41681- * N * *-*
OPTION - PACKING
A=BRASS - BULK PACK
B=BRASS - TUBE PACK
NO OF CKTS
DIM M.L.P
PLATING
VOID LOCATIONS
BLANK=NO VOIDS
NO=CKT NO VOIDED
MULT-VOIDS=51 UP

CENTERLINE OF PIN IN AREA SHOWN NOT TO VARY FROM CENTERLINE OF PIN AT -D- BY MORE THAN 0.20/.008 IN ANY DIRECTION.

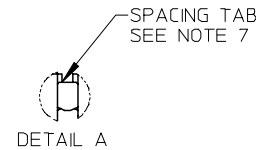
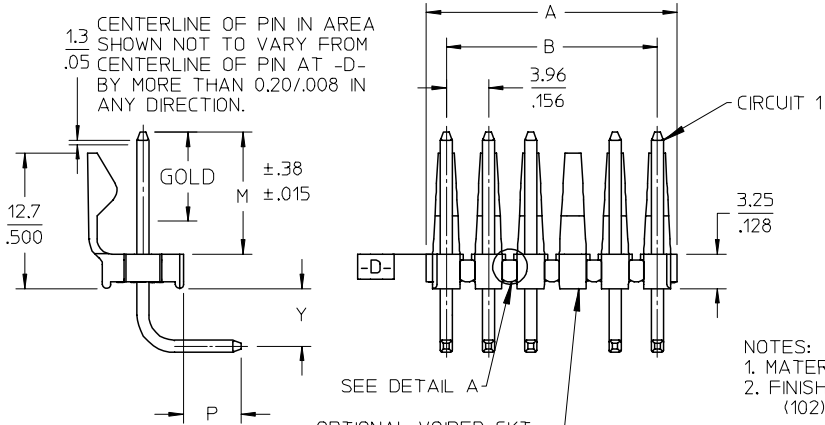

OPTIONAL VOIDED CKT. SEE CHART FOR LOCATIONS

NOTES:

- 1. MATERIAL: HEADER: POLYESTER, 94V-0, MOLDED BLACK
2. FINISH:
(102) OVERALL TIN: 0.00508/.000200 MIN OVER 0.00254/.000100 MIN COPPER.
(208) SELECT GOLD: 0.00038/.000015 MIN, *SELECT TIN: 0.00254/.000100 MIN, OVERALL NICKEL UNDERPLATE: 0.00127/.000050 MIN.
(228) SELECT GOLD: 0.00076/.000030 MIN, *SELECT TIN: 0.00254/.000100 MIN, OVERALL NICKEL UNDERPLATE: 0.00127/.000050 MIN.
*THE PRIMARY SHIPPING CARTON WILL BE LABELED "COMPLIANT TO RoHS DIRECTIVE 2002/95/EC AND ELV ANNEX II OF DIRECTIVE 2000/53/EC". CARTONS WITHOUT THIS LABEL MAY CONTAIN PRODUCT WITH TIN/LEAD PLATINGS.
3. PRODUCT SPECIFICATION: PS-08-50.
4. PACKAGING INFORMATION: SEE TABLES
5. SOLDERABILITY: PER SMES-152.
6. PIN PUSH-OUT FORCE: PRIOR TO SOLDERING, A 3 LB. MINIMUM FORCE IN EITHER DIRECTION SHALL BE REQUIRED TO PUSH THE PIN OUT OF THE HEADER.
7. PARTS ARE STACKABLE END TO END ON 3.96/.156 CENTERS.(SPACING TABS MUST BE REMOVED ON CIRCUIT SIZES 1-23 BEFORE PARTS ARE STACKABLE.

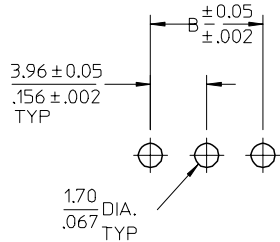

PCB LAYOUT: COMPONENT SIDE RECOMMENDED PCB THICKNESS: 1.57 ± .18 / .062 ± .007

Table with 3 columns: CIRCUIT, A, B. Rows 2-24 showing dimensions for various circuit configurations.

D

C

B

A

Table with columns: ADD DIMENSION, EC NO., DRWN:PR, CH'KD:ADERR, APPR:FSM, TH, DESCRIPTION, REV.

Table with columns: QUALITY SYMBOLS, GENERAL TOLERANCES (UNLESS SPECIFIED), DIMENSION STYLE MM/IN.

Table with columns: DIMENSION STYLE MM/IN, SCALE 2:1, DESIGN UNITS INCH, THIRD ANGLE PROJECTION.

Table with columns: DRAWN BY, CHECKED BY, APPROVED BY, MATERIAL NO., SEE CHART.

Table with columns: TITLE, MOLEX INCORPORATED, DOCUMENT NO., SHEET NO.

5

4

3

2

1

Header No:	41186-A-AN
Pin No:	2161-37(102)
Pin Length L	1.100 / 27.90
Mating M	.450 / 11.43
Gold:	NA
Bend Height: Y	.213 / 5.41
PC Tail P	.212 / 5.38
Tin:	OVERALL
Pack Per	PK-41672-001

Header No:	41186-A-AN
Pin No:	43294-0569
Pin Length L	1.100 / 27.90
Mating M	.450 / 11.43
Gold:	.270 / 6.86
Bend Height: Y	.213 / 5.41
PC Tail P	.212 / 5.38
Tin:	.200 / 5.08
Pack Per	PK-41672-001

Header No:	41186-A-AN
Pin No:	43294-0570
Pin Length L	1.100 / 27.90
Mating M	.450 / 11.43
Gold:	.270 / 6.86
Bend Height: Y	.213 / 5.41
PC Tail P	.212 / 5.38
Tin:	.200 / 5.08
Pack Per	PK-41672-001

Header No:	41186-A-AN
Pin No:	2161-37(501)
Pin Length L	1.100 / 27.90
Mating M	.450 / 11.43
Gold:	OVERALL
Bend Height: Y	.213 / 5.41
PC Tail P	.212 / 5.38
Tin:	NA
Pack Per	PK-41672-001

Ckts	Material No	Engineer Number	Material No	Engineer Number	Material No	Engineer Number	Material No	Engineer Number
2	026481026	A-41672-A02A102	41672-0001	A-41672-B02A208	41672-0024	A-41672-B02A228	026482026	A-41672-A02A501
3	026481036	A-41672-A03A102	41672-0002	A-41672-B03A208	41672-0025	A-41672-B03A228	026482036	A-41672-A03A501
4	026481046	A-41672-A04A102	41672-0003	A-41672-B04A208	41672-0026	A-41672-B04A228	026482046	A-41672-A04A501
5	026481056	A-41672-A05A102	41672-0004	A-41672-B05A208	41672-0027	A-41672-B05A228	026482056	A-41672-A05A501
6	026481066	A-41672-A06A102	41672-0005	A-41672-B06A208	41672-0028	A-41672-B06A228	026482066	A-41672-A06A501
7	026481076	A-41672-A07A102	41672-0006	A-41672-B07A208	41672-0029	A-41672-B07A228	026482076	A-41672-A07A501
8	026481086	A-41672-A08A102	41672-0007	A-41672-B08A208	41672-0030	A-41672-B08A228	026482086	A-41672-A08A501
9	026481096	A-41672-A09A102	41672-0008	A-41672-B09A208	41672-0031	A-41672-B09A228	026482096	A-41672-A09A501
10	026481106	A-41672-A10A102	41672-0009	A-41672-B10A208	41672-0032	A-41672-B10A228	026482106	A-41672-A10A501
11	026481116	A-41672-A11A102	41672-0010	A-41672-B11A208	41672-0033	A-41672-B11A228	026482116	A-41672-A11A501
12	026481126	A-41672-A12A102	41672-0011	A-41672-B12A208	41672-0034	A-41672-B12A228	026482126	A-41672-A12A501
13	026481136	A-41672-A13A102	41672-0012	A-41672-B13A208	41672-0035	A-41672-B13A228	026482136	A-41672-A13A501
14	026481146	A-41672-A14A102	41672-0013	A-41672-B14A208	41672-0036	A-41672-B14A228	026482146	A-41672-A14A501
15	026481156	A-41672-A15A102	41672-0014	A-41672-B15A208	41672-0037	A-41672-B15A228	026482156	A-41672-A15A501
16	026481166	A-41672-A16A102	41672-0015	A-41672-B16A208	41672-0038	A-41672-B16A228	026482166	A-41672-A16A501
17	026481176	A-41672-A17A102	41672-0016	A-41672-B17A208	41672-0039	A-41672-B17A228	026482176	A-41672-A17A501
18	026481186	A-41672-A18A102	41672-0017	A-41672-B18A208	41672-0040	A-41672-B18A228	026482186	A-41672-A18A501
19	026481196	A-41672-A19A102	41672-0018	A-41672-B19A208	41672-0041	A-41672-B19A228	026482196	A-41672-A19A501
20	026481206	A-41672-A20A102	41672-0019	A-41672-B20A208	41672-0042	A-41672-B20A228	026482206	A-41672-A20A501
21	026481216	A-41672-A21A102	41672-0020	A-41672-B21A208	41672-0043	A-41672-B21A228	026482216	A-41672-A21A501
22	026481226	A-41672-A22A102	41672-0021	A-41672-B22A208	41672-0044	A-41672-B22A228	026482226	A-41672-A22A501
23	026481236	A-41672-A23A102	41672-0022	A-41672-B23A208	41672-0045	A-41672-B23A228	026482236	A-41672-A23A501
24	026481246	A-41672-A24A102	41672-0023	A-41672-B24A208	41672-0046	A-41672-B24A228	026482246	A-41672-A24A501

REV: AB1	ECR/ECN INFORMATION:	TITLE: KK 156 HEADER ASSEMBLY FRICTION LOCK BREAKAWAY RIGHT ANGLE	SHEET No. - 2 -
	EC No.: UCP2006-1776		
	DATE: 4/11/2006		
DOCUMENT NUMBER: SD- 41672 -001	CREATED / REVISED BY: ADERR	CHECKED BY: SSOUSEK	APPROVED BY: FSMITH

Header No:	41186-A-AN
Pin No:	2161-37(102)
Pin Length L	1.100 / 27.90
Mating M	.523 / 13.28
Gold:	NA
Bend Height: Y	.213 / 5.41
PC Tail P	.136 / 3.45
Tin:	OVERALL
Pack Per	PK-41672-001

Header No:	41186-A-AN
Pin No:	2161-37(122)
Pin Length L	1.100 / 27.90
Mating M	.450 / 11.43
Gold:	NA
Bend Height: Y	.213 / 5.41
PC Tail P	.212 / 5.38
Tin:	OVERALL
Pack Per	PK-41672-001

Header No:	41186-A-AN
Pin No:	2161-37(503)
Pin Length L	1.100 / 27.90
Mating M	.450 / 11.43
Gold:	OVERALL
Bend Height: Y	.213 / 5.41
PC Tail P	.212 / 5.38
Tin:	NA
Pack Per	PK-41672-001

Header No:	41186-A-AN
Pin No:	2161-64(102)
Pin Length L	1.175 / 29.85
Mating M	.523 / 13.28
Gold:	OVERALL
Bend Height: Y	.217 / 5.51
PC Tail P	.207 / 5.26
Tin:	NA
Pack Per	PK-41672-001

Ckts	Material No	Engineer Number	Material No	Engineer Number	Material No	Engineer Number	Material No	Engineer Number
2	026582021	A-41672-A02C102	41672-0069	A-41672-A02A122	41672-0088	A-41672-A02A503	026486024	A-41672-A02B102
3	41672-0050	A-41672-A03C102	026582030	A-41672-A03A122	41672-0089	A-41672-A03A503	026486034	A-41672-A03B102
4	026582041	A-41672-A04C102	026582040	A-41672-A04A122	41672-0090	A-41672-A04A503	026486044	A-41672-A04B102
5	41672-0051	A-41672-A05C102	41672-0070	A-41672-A05A122	41672-0091	A-41672-A05A503	026486054	A-41672-A05B102
6	41672-0052	A-41672-A06C102	026582060	A-41672-A06A122	41672-0092	A-41672-A06A503	026486064	A-41672-A06B102
7	41672-0053	A-41672-A07C102	026582070	A-41672-A07A122	41672-0093	A-41672-A07A503	026486074	A-41672-A07B102
8	026582081	A-41672-A08C102	41672-0071	A-41672-A08A122	41672-0094	A-41672-A08A503	026486084	A-41672-A08B102
9	41672-0054	A-41672-A09C102	41672-0072	A-41672-A09A122	41672-0095	A-41672-A09A503	026486094	A-41672-A09B102
10	41672-0055	A-41672-A10C102	41672-0073	A-41672-A10A122	026586101	A-41672-A10A503	026486104	A-41672-A10B102
11	41672-0056	A-41672-A11C102	41672-0074	A-41672-A11A122	41672-0096	A-41672-A11A503	026486114	A-41672-A11B102
12	41672-0057	A-41672-A12C102	41672-0075	A-41672-A12A122	026586121	A-41672-A12A503	026486124	A-41672-A12B102
13	41672-0058	A-41672-A13C102	41672-0076	A-41672-A13A122	41672-0097	A-41672-A13A503	026486134	A-41672-A13B102
14	41672-0059	A-41672-A14C102	41672-0077	A-41672-A14A122	41672-0098	A-41672-A14A503	026486144	A-41672-A14B102
15	41672-0060	A-41672-A15C102	41672-0078	A-41672-A15A122	41672-0099	A-41672-A15A503	026486154	A-41672-A15B102
16	41672-0061	A-41672-A16C102	41672-0079	A-41672-A16A122	41672-0100	A-41672-A16A503	026486164	A-41672-A16B102
17	41672-0062	A-41672-A17C102	41672-0080	A-41672-A17A122	41672-0101	A-41672-A17A503	026486174	A-41672-A17B102
18	41672-0063	A-41672-A18C102	41672-0081	A-41672-A18A122	41672-0102	A-41672-A18A503	026486184	A-41672-A18B102
19	41672-0064	A-41672-A19C102	41672-0082	A-41672-A19A122	41672-0103	A-41672-A19A503	026486194	A-41672-A19B102
20	41672-0065	A-41672-A20C102	41672-0083	A-41672-A20A122	41672-0104	A-41672-A20A503	026486204	A-41672-A20B102
21	41672-0066	A-41672-A21C102	41672-0084	A-41672-A21A122	41672-0105	A-41672-A21A503	026486214	A-41672-A21B102
22	41672-0067	A-41672-A22C102	41672-0085	A-41672-A22A122	026586221	A-41672-A22A503	026486224	A-41672-A22B102
23	41672-0068	A-41672-A23C102	41672-0086	A-41672-A23A122	41672-0106	A-41672-A23A503	026486234	A-41672-A23B102
24	026582241	A-41672-A24C102	41672-0087	A-41672-A24A122	41672-0107	A-41672-A24A503	026486244	A-41672-A24B102

REV: AB1	ECR/ECN INFORMATION:	TITLE: KK 156 HEADER ASSEMBLY FRICTION LOCK BREAKAWAY RIGHT ANGLE	SHEET No.	
	EC No.: UCP2006-1776		- 3 -	
	DATE: 4/11/2006			
DOCUMENT NUMBER: SD- 41672 -001		CREATED / REVISED BY: ADERR	CHECKED BY: SSOUSEK	APPROVED BY: FSMITH

Header No:	41186-A-AN
Pin No:	2161-96(501)
Pin Length L	1.531 / 38.89
Mating M	.500 / 12.70
Gold:	OVERALL
Bend Height: Y	.213 / 5.41
PC Tail P	.592 / 15.04
Tin:	OVERALL
Pack Per	PK-41672-001

Header No:	41186-A-AN
Pin No:	2161-37(501)
Pin Length L	1.100 / 27.90
Mating M	.523 / 13.28
Gold:	OVERALL
Bend Height: Y	.213 / 5.41
PC Tail P	.136 / 3.45
Tin:	NA
Pack Per	PK-41672-001

Header No:	41186-A-AN
Pin No:	2161-19(102)
Pin Length L	1.032 / 26.21
Mating M	.458/11.63 REF
Gold:	NA
Bend Height: Y	.221 / 5.61
PC Tail P	.125+- .015
Tin:	OVERALL
Pack Per	PK-41672-001

Header No:	41186-A-AN
Pin No:	2161-19(102)
Pin Length L	1.032 / 26.21
Mating M	.461 / 11.71
Gold:	NA
Bend Height: Y	.213 / 5.41
PC Tail P	.130 / 3.30
Tin:	NA
Pack Per	PK-41672-001

Ckts	Material No	Engineer Number	Material No	Engineer Number	Material No	Engineer Number	Material No	Engineer Number
2	41672-0109	A-41672-A02D501	026586020	A-41672-A02C501	026482029	A-41672-A02E102	41672-0151	A-41672-A02F102
3	41672-0110	A-41672-A03D501	026586030	A-41672-A03C501	026482039	A-41672-A03E102	41672-0152	A-41672-A03F102
4	41672-0111	A-41672-A04D501	41672-0131	A-41672-A04C501	026482049	A-41672-A04E102	41672-0153	A-41672-A04F102
5	41672-0112	A-41672-A05D501	41672-0132	A-41672-A05C501	026482059	A-41672-A05E102	41672-0154	A-41672-A05F102
6	41672-0113	A-41672-A06D501	41672-0133	A-41672-A06C501	026482069	A-41672-A06E102	41672-0155	A-41672-A06F102
7	41672-0114	A-41672-A07D501	41672-0134	A-41672-A07C501	026482079	A-41672-A07E102	41672-0156	A-41672-A07F102
8	41672-0115	A-41672-A08D501	026586080	A-41672-A08C501	026482089	A-41672-A08E102	41672-0157	A-41672-A08F102
9	41672-0116	A-41672-A09D501	41672-0135	A-41672-A09C501	026482099	A-41672-A09E102	41672-0158	A-41672-A09F102
10	41672-0117	A-41672-A10D501	41672-0136	A-41672-A10C501	026482109	A-41672-A10E102	41672-0159	A-41672-A10F102
11	41672-0118	A-41672-A11D501	41672-0137	A-41672-A11C501	026482119	A-41672-A11E102	41672-0160	A-41672-A11F102
12	41672-0119	A-41672-A12D501	41672-0138	A-41672-A12C501	026482129	A-41672-A12E102	41672-0161	A-41672-A12F102
13	41672-0120	A-41672-A13D501	41672-0139	A-41672-A13C501	026482139	A-41672-A13E102	41672-0162	A-41672-A13F102
14	41672-0121	A-41672-A14D501	41672-0140	A-41672-A14C501	026482149	A-41672-A14E102	41672-0163	A-41672-A14F102
15	41672-0122	A-41672-A15D501	41672-0141	A-41672-A15C501	026482159	A-41672-A15E102	41672-0164	A-41672-A15F102
16	41672-0123	A-41672-A16D501	41672-0142	A-41672-A16C501	026482169	A-41672-A16E102	41672-0165	A-41672-A16F102
17	41672-0124	A-41672-A17D501	41672-0143	A-41672-A17C501	026482179	A-41672-A17E102	41672-0166	A-41672-A17F102
18	41672-0125	A-41672-A18D501	41672-0144	A-41672-A18C501	026482189	A-41672-A18E102	41672-0167	A-41672-A18F102
19	41672-0126	A-41672-A19D501	41672-0145	A-41672-A19C501	026482199	A-41672-A19E102	41672-0168	A-41672-A19F102
20	41672-0127	A-41672-A20D501	41672-0146	A-41672-A20C501	026482209	A-41672-A20E102	41672-0169	A-41672-A20F102
21	41672-0128	A-41672-A21D501	41672-0147	A-41672-A21C501	026482219	A-41672-A21E102	41672-0170	A-41672-A21F102
22	41672-0129	A-41672-A22D501	41672-0148	A-41672-A22C501	026482229	A-41672-A22E102	41672-0171	A-41672-A22F102
23	41672-0130	A-41672-A23D501	41672-0149	A-41672-A23C501	026482239	A-41672-A23E102	41672-0172	A-41672-A23F102
24	026586242	A-41672-A24D501	41672-0150	A-41672-A24C501	026482249	A-41672-A24E102	41672-0173	A-41672-A24F102

REV: AB1	ECR/ECN INFORMATION:	TITLE: KK 156 HEADER ASSEMBLY FRICTION LOCK BREAKAWAY RIGHT ANGLE	SHEET No.	
	EC No.: UCP2006-1776		- 4 -	
	DATE: 4/11/2006			
DOCUMENT NUMBER: SD- 41672 -001		CREATED / REVISED BY: ADERR	CHECKED BY: SSOUSEK	APPROVED BY: FSMITH

6

5

4

3

2

1

CENTERLINE OF PIN IN AREA SHOWN NOT TO VARY FROM CENTERLINE OF PIN AT -D- BY MORE THAN 0.13/.005 IN ANY DIRECTION.

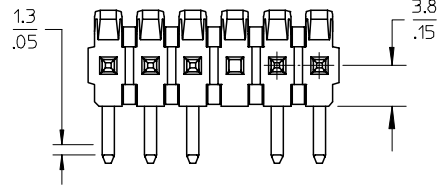

A-41681- * N * *-
OPTION - PACKING
A=BRASS - BULK PACK
B=BRASS - TUBE PACK
NO OF CKTS
DIM M.L.P
PLATING
VOID LOCATIONS
BLANK=NO VOIDS
NO=CKT NO VOIDED
MULT-VOIDS=51 UP

CENTERLINE OF PIN IN AREA SHOWN NOT TO VARY FROM CENTERLINE OF PIN AT -D- BY MORE THAN 0.20/.008 IN ANY DIRECTION.



OPTIONAL VOIDED CKT. SEE CHART FOR LOCATIONS

NOTES:

- 1. MATERIAL: HEADER: POLYESTER, 94V-0, MOLDED BLACK
2. FINISH: (228) SELECT GOLD: 0.00076/.000030 MIN. *SELECT TIN: 0.00254/.000100 MIN. OVERALL NICKEL UNDERPLATE: 0.00127/.000050 MIN. *THE PRIMARY SHIPPING CARTON WILL BE LABELED "COMPLIANT TO ROHS DIRECTIVE 2002/95/EC AND ELV ANNEX II OF DIRECTIVE 2000/53/EC". CARTONS WITHOUT THIS LABEL MAY CONTAIN PRODUCT WITH TIN/LEAD PLATINGS.
3. PRODUCT SPECIFICATION: PS-08-50.
4. PACKAGING INFORMATION: SEE CHARTS
5. SOLDERABILITY: PER SMES-152.
6. PIN PUSH-OUT FORCE: PRIOR TO SOLDERING, A 3 LB. MINIMUM FORCE IN EITHER DIRECTION SHALL BE REQUIRED TO PUSH THE PIN OUT OF THE HEADER.
7. PARTS ARE STACKABLE END TO END ON 3.96/.156 CENTERS.(SPACING TABS MUST BE REMOVED ON CIRCUIT SIZES 1-23 BEFORE PARTS ARE STACKABLE.

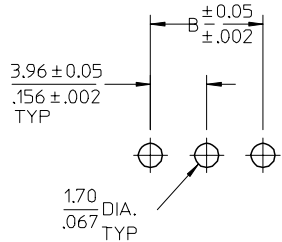

PCB LAYOUT:COMPONENT SIDE RECOMMENDED PCB THICKNESS: (1.57 +/- .18)/.062 +/- .007

Table with 3 columns: CIRCUIT, A, B. Rows 2-24 showing dimensions for various circuit configurations.

D

D

C

C

B

B

A

A

Technical drawing header containing: ADD DIMENSION, EC NO: UCP2006-2296, DRWN:PRIDDER, CHKD:ADERR, APPR:FSMITH, QUALITY SYMBOLS, GENERAL TOLERANCES, DIMENSION STYLE, SCALE 2:1, DESIGN UNITS INCH, THIRD ANGLE PROJECTION, TITLE KK .156 HEADER ASSEMBLY, MOLEX INCORPORATED, DOCUMENT NO. SD-41672-002, SHEET NO. 1 OF *

5

4

3

2

1

Header No:	41186-A-AN
Pin No:	43294-0570
Pin Length L	1.100 / 27.90
Mating M	.450 / 11.43
Gold:	.270 / 6.86
Bend Height: Y	.213 / 5.41
PC Tail P	.212 / 5.38
Tin:	.200 / 5.08
Pack Per	PK-41672-001

Header No:	
Pin No:	
Pin Length L	
Mating M	
Gold:	
Bend Height: Y	
PC Tail P	
Tin:	
Pack Per	

Header No:	
Pin No:	
Pin Length L	
Mating M	
Gold:	
Bend Height: Y	
PC Tail P	
Tin:	
Pack Per	

Header No:	
Pin No:	
Pin Length L	
Mating M	
Gold:	
Bend Height: Y	
PC Tail P	
Tin:	
Pack Per	

Ckts	Material No	Engineer Number	Material No	Engineer Number	Material No	Engineer Number	Material No	Engineer Number
2								
3								
4								
5								
6	50-29-1898	A-41672-B06A228						
7								
8								
9								
10								
11								
12								
13								
14								
15								
16								
17								
18								
19								
20								
21								
22								
23								
24								

A1	REV:	ECR/ECN INFORMATION:	TITLE:	KK 156 HEADER ASSEMBLY FRICITION LOCK BREAKAWAY RIGHT ANGLE (LEAD-FREE)	SHEET No.
		EC No.:			- 2 -
		DATE:			
DOCUMENT NUMBER:		CREATED / REVISED BY:	CHECKED BY:	APPROVED BY:	
SD- 41672 -002		ADERR	SSOUSEK	FSMITH	