

Part Number: [0008580111](#)
Status: **Active**
Description: Trifurcon™ Crimp Terminal 6438, 18-20 AWG, Bag, Phosphor Bronze Selective Gold (Au)

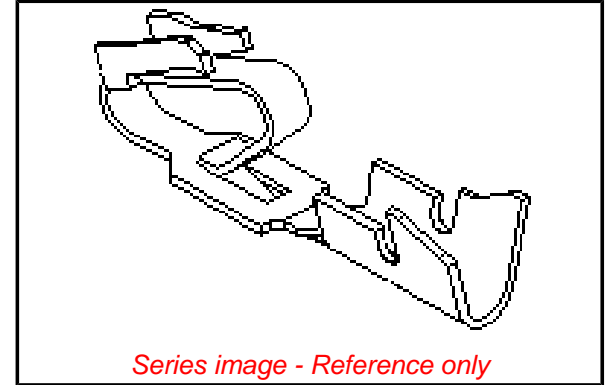

General

Product Family	Crimp Terminals
Series	6838
Product Name	Trifurcon™

Physical

Gender	Female
Material - Metal	Phosphor Bronze
Material - Plating Mating	Gold
Material - Plating Termination	Nickel
Packaging Type	Bag
Plating min: Mating (µin)	30
Plating min: Mating (µm)	0.75
Plating min: Termination (µin)	50
Plating min: Termination (µm)	1.25
Termination Interface: Style	Crimp or Compression
Wire Insulation Diameter	2.79mm (.110") max.
Wire Size AWG	18
Wire Size AWG	20
Wire Size mm²	N/A

Material Info

Old Part Number	6838-A(P561)L
-----------------	---------------

Reference - Drawing Numbers

Product Specification	PS-40-02
Sales Drawing	SD-6838

EU RoHS

**ELV and RoHS
Compliant**

China RoHS



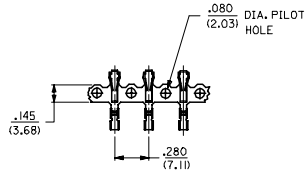

CARRIER STRIP DETAIL

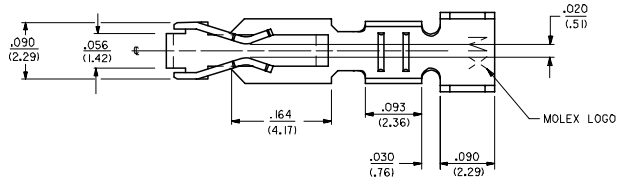

- NOTES:
1. MATERIAL; SEE LEGEND
 2. FINISH:
 - *909 - OVERALL HOT TIN DIF: .000100/(0.00254) MIN.
 - 102 - OVERALL TIN: .000200/(0.00508) MIN.
 - OVERALL COPPER: .000100/(0.00254) MIN.
 - 132 - OVERALL TIN: .000200/(0.00508) MIN.
 - OVERALL COPPER: .000200/(0.00508) MIN.
 - 503 - OVERALL HARD GOLD: .000030/(0.00076) MIN.
 - OVERALL NICKEL: .000050/(0.00127) MIN.
 - 550 - SELECT HARD GOLD: .000015/(0.00038) MIN.
 - OVERALL NICKEL: .000030/(0.00076) MIN.
 - OVERALL HARD GOLD FLASH: .000002/(0.00005) MIN.
 - 555 - SELECT HARD GOLD: .000015/(0.00038) MIN.
 - OVERALL NICKEL: .000030/(0.00076) MIN.
 - 558 - SELECT HARD GOLD: .000030/(0.00076) MIN.
 - OVERALL NICKEL: .000050/(0.00127) MIN.
 - OVERALL HARD GOLD FLASH: .000002/(0.00005) MIN.
 - 561 - SELECT HARD GOLD: .000030/(0.00076) MIN.
 - OVERALL NICKEL: .000050/(0.00127) MIN.
 - * THE PRIMARY SHIPPING CARTON WILL BE LABELED "COMPLIANT TO ROHS DIRECTIVE 2002/95/EC AND ELV ANNEX II OF DIRECTIVE 2000/53/EC." CARTONS WITHOUT THIS LABEL MAY CONTAIN PRODUCT WITH TIN-LEAD PLATING.
 3. PRODUCT SPECIFICATION: PS-40-02
 4. PACKAGING SPECIFICATION: CHAIN FORM SEE PK-6838-001
 5. TERMINAL FOR USE IN HOUSING NOS. 6442 AND 41695
 6. THIS PART WITH CRIMP FOR 22-26 AWG. WIRE. SEE DWG. NO. 7258
 7. CRIMP FOR 18 TO 20 GA. WIRE WITH MAX. INSULATION DIA. OF .100/(2.79). STRIP LENGTH OF .125/100 / (3.18/2.54)
 8. DIMENSIONS GIVEN ACROSS CENTERLINES ARE SYMMETRICAL ABOUT THOSE CENTERLINES WITHIN HALF THE TOTAL TOLERANCE.
 9. THIS PART CONFORMS TO CLASS B REQUIREMENTS OF COSMETIC SPECIFICATION PS-45499-002.

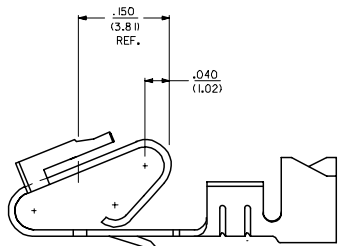

SELECTIVE PLATING LOCATION

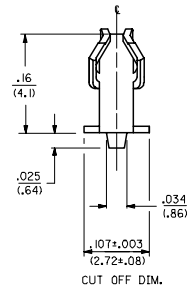

CUT OFF DIM.

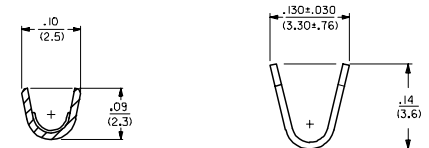
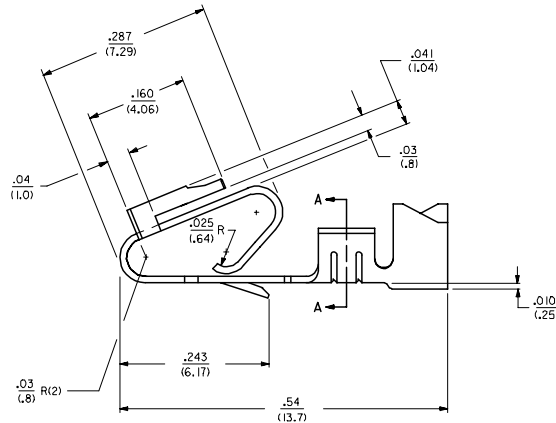

SECTION A-A

- LEGEND: 6838- ()
- WINDING
 - A= PER DETAIL A
 - BLANK= PER DETAIL B
 - FORM
 - BLANK= CHAIN
 - L= LOOSE
 - PLATING
 - SEE NOTE 2
- MATERIAL:
 (.27)/.0106 THK
 BLANK=BRASS
 A=PHOS BRONZE

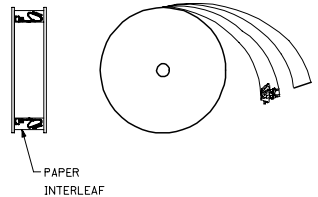

WINDING DETAIL 'A'

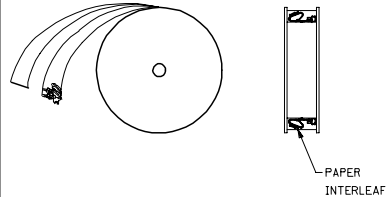

WINDING DETAIL 'B'

ADD NOTE 9 EC NO: UCP2008-0005 DRAWN BY: 2007/07/03 CHECKED BY: 2007/07/09 APPROVED BY: 2007/07/09 APPROVAL SIGNATURE:	QUALITY SYMBOLS ▽=0 ▽=0	GENERAL TOLERANCES (UNLESS SPECIFIED)		DIMENSION STYLE IN/MM		SCALE	DESIGN UNITS	THIRD ANGLE PROJECTION		
		mm	INCH	DRAWN BY	DATE	TITLE	---	INCH	TRIFURCON TERMINAL	
		4 PLACES ± --- ± ---		GUZIK	11/15/89	CRIMP TYPE, .156 CENTERS 18 TO 20 AWG WIRE			MOLEX INCORPORATED	
		3 PLACES ± --- ± .010		CHECKED BY	DATE		SD-6838		SHEET NO. 1 OF 2	
2 PLACES ± 0.25 ± .015		PATEL	11/15/89	MATERIAL NO. DOCUMENT NO.			THIS DRAWING CONTAINS INFORMATION THAT IS PROPRIETARY TO MOLEX INCORPORATED AND SHOULD NOT BE USED WITHOUT WRITTEN PERMISSION			
1 PLACE ± 0.36 ± ---		APPROVED BY	DATE	SIZE D						
ANGULAR ±1/2°		LENZ	11/15/89							

6838-(*)**		6838-A(*)**													
PART NO.	ENG. NO.	PART NO.	ENG. NO.	PART NO.	ENG. NO.	PART NO.	ENG. NO.	PART NO.	ENG. NO.	PART NO.	ENG. NO.	PART NO.	ENG. NO.	PART NO.	ENG. NO.
08-50-0187	6838-(P909)														
08-50-0189	6838-(P909)L	08-58-0187	6838-A(P558)												
08-50-0275	6838-(P909)-A	08-58-0189	6838-A(P558)L												
08-50-0026	6838-(P102)	08-60-0001	6838-A(132)												
	6838-(P102)L	08-60-0002	6838-A(132)L												
08-50-0028	6838-(102)	08-58-0102	6838-A(558)												
08-50-0029	6838-(102)L		6838-A(558)L												
		08-58-0108	6838-A(503)												
		08-58-0109	6838-A(503)L												
		08-52-0112	6838-A(P909)												
		08-52-0113	6838-A(P909)L												
		08-50-0024	6838-A(102)												
		08-50-0251	6838-A(102)L												
		08-58-0105	6838-A(P555)												
		08-58-0106	6838-A(P555)L												
		08-58-0110	6838-A(P561)												
		08-58-0111	6838-A(P561)L												
		08-58-0118	6838-A(561)												
		08-58-0119	6838-A(561)L												
		08-58-0131	6838-A(550)												
		08-58-0132	6838-A(550)L												

UPDATE TITLE BLOCK DEC NO: UCP2008-0005 2007/07/03 DRAWN BY: JORWANDARR 2007/07/09 CHECKED BY: CHUCK BELL 2007/07/09 APPROVED BY: APPRESMITH 2007/07/09 REV DESCRIPTION	QUALITY SYMBOLS ▽=0 ▽=0	GENERAL TOLERANCES (UNLESS SPECIFIED) <table border="1"> <tr> <th></th> <th>mm</th> <th>INCH</th> </tr> <tr> <td>4 PLACES</td> <td>± .005</td> <td>± .0005</td> </tr> <tr> <td>3 PLACES</td> <td>± .005</td> <td>± .0005</td> </tr> <tr> <td>2 PLACES</td> <td>± .005</td> <td>± .0005</td> </tr> <tr> <td>1 PLACE</td> <td>± .005</td> <td>± .0005</td> </tr> </table>		mm	INCH	4 PLACES	± .005	± .0005	3 PLACES	± .005	± .0005	2 PLACES	± .005	± .0005	1 PLACE	± .005	± .0005	DIMENSION STYLE IN/MM DRAWN BY: GUZIK DATE: 11/15/89 CHECKED BY: PATEL DATE: 11/15/89 APPROVED BY: LENZ DATE: 11/15/89	SCALE: --- DESIGN UNITS: INCH THIRD ANGLE PROJECTION	TITLE: TRIFURCON TERMINAL CRIMP TYPE, .156 CENTERS 18 TO 20 AWG WIRE MOLEX INCORPORATED DOCUMENT NO: SD-6838 SHEET NO: 2 OF 2
		mm	INCH																	
	4 PLACES	± .005	± .0005																	
	3 PLACES	± .005	± .0005																	
2 PLACES	± .005	± .0005																		
1 PLACE	± .005	± .0005																		
DRAFT WHERE APPLICABLE MUST REMAIN WITHIN DIMENSIONS		MATERIAL NO: SEE CHART SIZE: D	THIS DRAWING CONTAINS INFORMATION THAT IS PROPRIETARY TO MOLEX INCORPORATED AND SHOULD NOT BE USED WITHOUT WRITTEN PERMISSION																	

3.96mm (.156") Pitch KK[®] Crimp Terminal

2478/2578

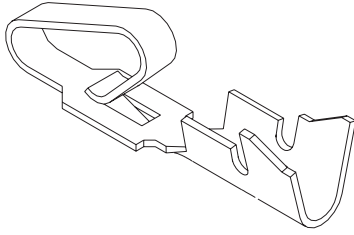

Features and Benefits

- Double cantilever design
- Single beam terminal is available for low insertion force 7821 Series (contact Molex)
- For low-level current and voltage use Gold plating
- Phosphor Bronze is recommended for rated current
- Complete line of terminal crimping equipment available (see Application Tooling section of this catalog)

Reference Information

Product Specification: PS-08-50
Packaging: Reel or bag
Tooling Information: See crimp tooling section
UL File No.: E29179
CSA File No.: LR19980
Use With: 2139, 3069 and 41695
Designed In: Inches

Electrical

Voltage: 250V AC max.
Current: Max.

AWG	18	20	22	24	26
Phosphor Bronze	7.00A	6.25A	5.50A	5.00A	4.50A
Brass	5.00A	4.75A	4.50A	4.25A	4.00A

Contact Resistance: 6 milliohms max.
Dielectric Withstanding Voltage: 1500V AC
Insulation Resistance: 50K Megohms min.

Mechanical

Contact Insertion Force: 1.8kg (4 lb) max.
Contact Retention to Housing: 3.6kg (8 lb) min.
Wire Pull-Out Force: 20 lb max./18 AWG
Normal Force: 0.75kg (1.65 lb)
Durability: 25 cycles max.

Physical

Contact: Brass or Phosphor Bronze
Plating: See Table
Operating Temperature: Phosphor Bronze—0 to +75°C
Brass—0 to +50°C

Wire Size AWG	Insulation OD	Series	Material	Order No.						Lead-free
				Tin Plating		Gold Plating No. 1		Gold Plating No. 2		
				Reel	Bag	Reel	Bag	Reel	Bag	
18-20	2.79 (.110)	max. 2478	Phosphor Bronze	08-52-0071	08-52-0072	08-58-0121	08-58-0122	08-65-0114	08-65-0115	Yes
			Brass	08-50-0105	08-50-0106	08-56-0105	08-56-0106	08-55-0103	08-55-0104	
22-26	1.65 (.065)	max. 2578	Phosphor Bronze	08-50-0133	08-50-0134	08-58-0125	08-58-0126	08-65-0116	08-65-0117	
			Brass	08-50-0107	08-50-0108	08-56-0107	08-56-0108	08-55-0105	08-55-0106	

Recommended wire range assumes stranded wire
Plating No. 1: 20µm min. Gold in contact area with a flash overall
Plating No. 2: 15µm min. Gold in contact area only

3.96mm (.156") Pitch KK[®] Crimp Terminal

6838/7258
Trifurcon[™]

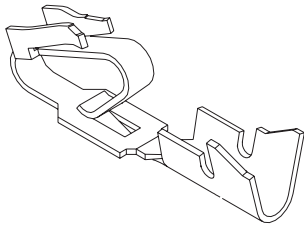

Features and Benefits

- Complete line of terminal crimping equipment available (see Application Tooling section of this catalog)
- Accommodates 18 to 26 AWG
- Trifurcon design provides 3 distinct points of contact
- Ideal choice where high shock or vibration exists
- For low current/voltage, Gold is recommended
- Phosphor Bronze recommended for rated current

Reference Information

Product Specification: PS-40-02
Packaging: Reel or bag
Tooling Information: See crimp tooling section
Use With: 6442 and 41695 crimp terminal housings
Designed In: Inches

Electrical

Voltage: 250V AC max.
Current: Max.

AWG	18	20	22	24	26
Phosphor Bronze	7.00A	6.25A	5.50A	5.00A	4.50A
Brass	5.00A	4.75A	4.50A	4.25A	4.00A

Contact Resistance: 6 milliohms max.
Dielectric Withstanding Voltage: 1500V AC
Insulation Resistance: 50K Megohms min.

Mechanical

Contact Insertion Force: 1.8kg (4 lb) max.
Contact Retention to Housing: 3.6kg (8 lb) min.
Wire Pull-Out Force: 20 lb max./18 AWG
Normal Force: 0.75kg (1.65 lb)
Durability: 25 cycles max.

Physical

Contact: Brass or Phosphor Bronze
Plating: See Table
Operating Temperature: Phosphor Bronze—0 to +75°C
Brass—0 to +50°C

Wire Size AWG	Insulation OD	Series	Material	Order No.						Lead-free
				Tin Plating		Gold Plating		Select Gold Plating		
				Reel	Bag	Reel	Bag	Reel	Bag	
18-20	2.79 (.110) max.	6838	Phosphor Bronze	08-52-0112	08-52-0113	08-58-0187	08-58-0189	08-58-0110	08-58-0111	Yes
			Brass	08-50-0187	08-50-0189					
22-26	1.65 (.065) max.	7258	Phosphor Bronze	08-52-0124	08-52-0125	08-56-0123	08-56-0124	08-65-0121	08-65-0122	
			Brass	08-50-0183	08-50-0185					

