

750H Hermetic Octal Relays, 8-Pin/DPDT, 12 Amp Rating (DC & AC)

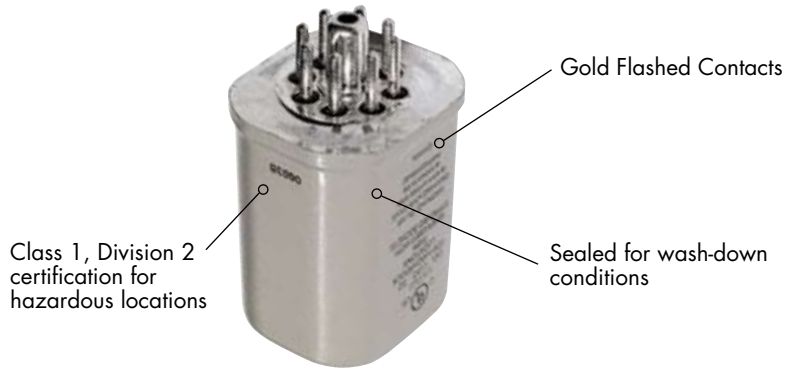

General Specifications		(UL 508)	Units	750XBXH	Standard
Contact Characteristics					
Number and type of Contacts					DPDT
Contact materials					Silver Alloy
Thermal (Carrying) Current			A		12
Maximum Switching Voltage			V		300
Switching Current @ Voltage		~	General Purpose		12A @ 240V 50/60Hz
		~	General Purpose		12A @ 120V 50/60Hz
		∴	Resistive		12A @ 28V
			HP		1/3 @ 120VAC
			HP		1/2 @ 240 VAC
			Pilot Duty		B300
Minimum Switching Requirement			mA		100 @ 5VDC (.5W)
Coil Characteristics					
Voltage Range		~	V		6...240
		∴	V		6...125
Operating Range	% of Nominal	~			85% to 110%
		∴			80% to 110%
Average consumption		~	VA		1.2
		∴	W		0.9
Drop-out voltage threshold		~			15%
		∴			10%
Performance Characteristics					
Electrical Life (UL508)	Operations @ Rated Current				100,000
Mechanical Life	Unpowered				10,000,000
Operating time (response time)			ms		20
Dielectric strength	Between coil and contact	~	Vrms		1500
	Between poles	~	Vrms		1500
	Between contacts	~	Vrms		1500
Environment					
Product certifications	Standard version				UL
Ambient air temperature around the device	Storage		°C		-40...+85
	Operation		°C		-40...+55
Vibration resistance	Operational		g-n		3, 10 - 55 Hz
Shock resistance			g-n		10
Degree of protection					IP 67
Weight			grams		130

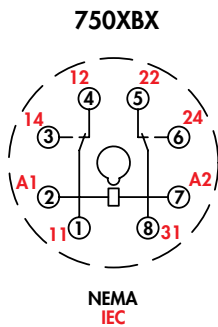

Wiring Diagram
Bottom View

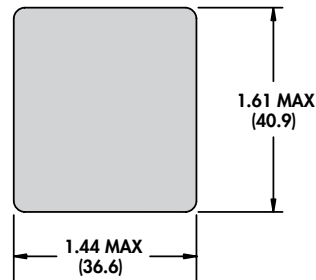
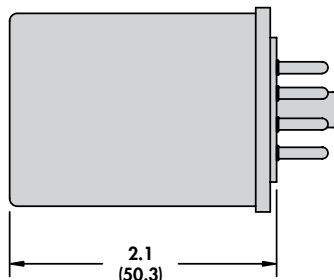



750H 8-pin

Standard Part Numbers

BOLD-FACED PART NUMBERS ARE NORMALLY STOCKED

Nominal Voltage	Coil Resistance	DPDT Part Number 12 Amp
AC Operated		
6 VAC 50/60 Hz	4.2 Ohms	750XBXH-6A
12 VAC 50/60 Hz	18 Ohms	750XBXH-12A
24 VAC 50/60 Hz	72 Ohms	750XBXH-24A
120 VAC 50/60 Hz	1700 Ohms	750XBXH-120A
220-240 VAC 50/60 Hz	7200 Ohms	750XBXH-220/240A
DC Operated		
6 VDC	32 Ohms	750XBXH-6D
12 VDC	120 Ohms	750XBXH-12D
24 VDC	470 Ohms	750XBXH-24D
48 VDC	1800 Ohms	750XBXH-48D
110-125 VDC	10000 Ohms	750XBXH-110/125D

Custom Relay Part Number Builder

Series	Contact Configuration	Hermetic	Contact Code	Coil Voltage
750	XBX	H		240A
750	XBX = DPDT		12 Amp Silver Alloy = No Code	VAC = 6 - 240A VDC = 6 - 125D

For other mating sockets, see Section 2: 70-750E8-1, 70-464-1, 70-169-1

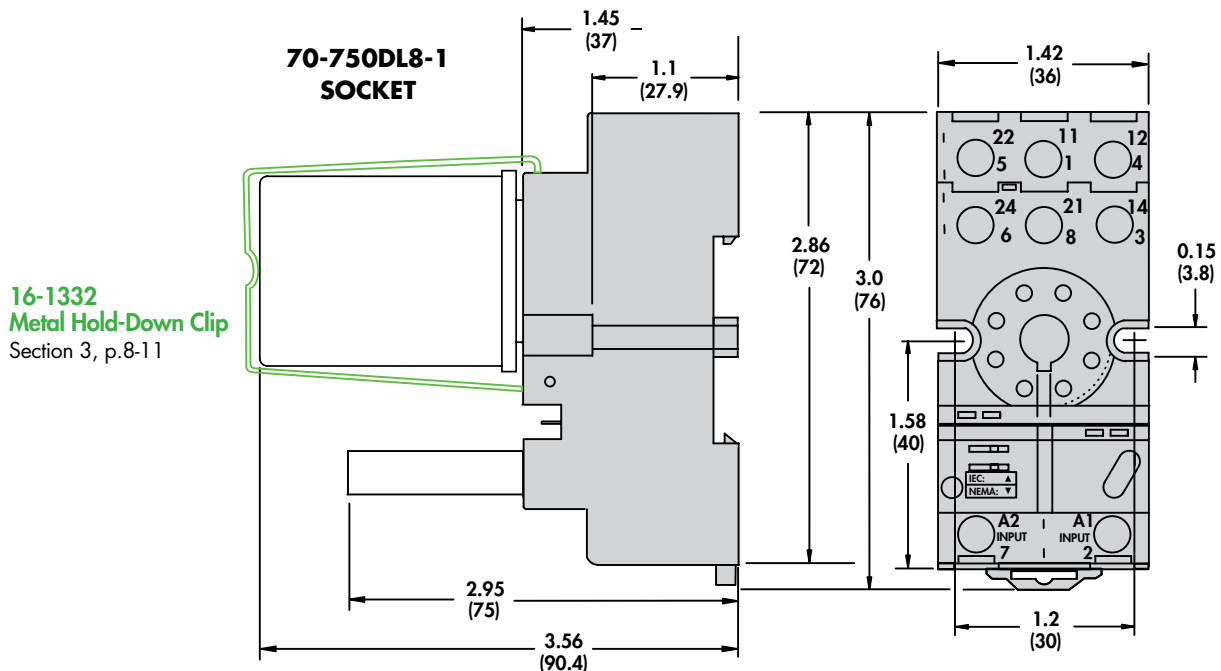

750H Hermetic Octal Relays, 11-Pin/3PDT, 12 Amp Rating (DC & AC)

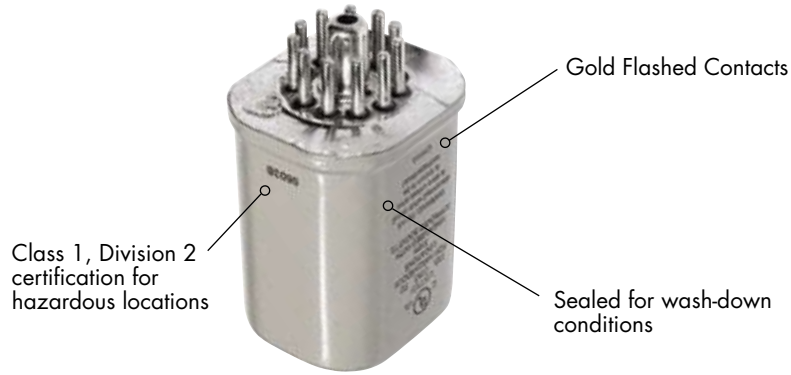

General Specifications		(UL 508)	Units	750XCXH
Contact Characteristics				
Number and type of Contacts				3PDT
Contact materials				Silver Alloy
Thermal (Carrying) Current			A	12
Maximum Switching Voltage			V	300
Switching Current @ Voltage		~	General Purpose	12A @ 240V 50/60Hz
		~	General Purpose	12A @ 120V 50/60Hz
		∴	Resistive	12A @ 28V
			HP	1/3 @ 120VAC
			HP	1/2 @ 240 VAC
Minimum Switching Requirement			Pilot Duty	B300
			mA	100 @ 5VDC (.5W)
Coil Characteristics				
Voltage Range		~	V	6...240
		∴	V	6...125
Operating Range	% of Nominal	~		85% to 110%
		∴		80% to 110%
Average consumption		~	VA	2
		∴	W	1.2
Drop-out voltage threshold		~		15%
		∴		10%
Performance Characteristics				
Electrical Life (UL508)	Operations @ Rated Current			100,000
Mechanical Life	Unpowered			10,000,000
Operating time (response time)			ms	20
Dielectric strength	Between coil and contact	~	Vrms	1500
	Between poles	~	Vrms	1500
	Between contacts	~	Vrms	1500
Environment				
Product certifications	Standard version			UL
Ambient air temperature around the device	Storage		°C	-40...+85
	Operation		°C	-40...+55
Vibration resistance	Operational		g-n	3, 10 - 55 Hz
Shock resistance			g-n	10
Degree of protection				IP 67
Weight			grams	130

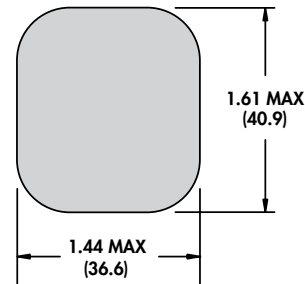
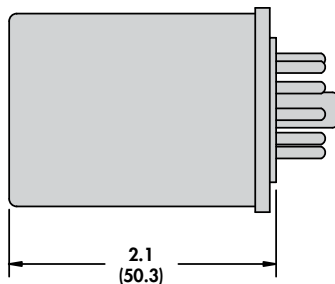
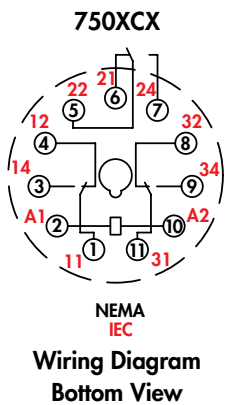



750H 11-pin

Standard Part Numbers

BOLD-FACED PART NUMBERS ARE NORMALLY STOCKED

Nominal Voltage	Coil Resistance	3PDT Part Number 12 Amp
AC Operated		
6 VAC 50/60 Hz	4.2 Ohms	750XCXH-6A
12 VAC 50/60 Hz	18 Ohms	750XCXH-12A
24 VAC 50/60 Hz	72 Ohms	750XCXH-24A
120 VAC 50/60 Hz	1700 Ohms	750XCXH-120A
220-240 VAC 50/60 Hz	7200 Ohms	750XCXH-220/240A
DC Operated		
6 VDC	32 Ohms	750XCXH-6D
12 VDC	120 Ohms	750XCXH-12D
24 VDC	470 Ohms	750XCXH-24D
48 VDC	1800 Ohms	750XCXH-48D
110-125 VDC	10000 Ohms	750XCXH-110/125D

Custom Relay Part Number Builder

750	XCX	H	240A
Series	Contact Configuration	Hermetic	Contact Code
750	XCX = 3PDT		12 Amp Silver Alloy = No Code
			Coil Voltage
			VAC = 6 - 240A
			VDC = 6 - 125D

For other mating sockets, see Section 2: 70-750E11-1, 70-465-1, 70-170-1

16-1332
Metal Hold-Down Clip
Section 3, p.8-11

