

# Latching, Sequence and Impulse Relays – Application Data

## Energy Conservation Relays

In many applications it is important for the customer to conserve electrical energy. One approach to energy conservation in an electrical system is to use relays that do not require constant power to maintain contact closure.

“Latching relay” is a generic term that is used to describe a relay that maintains its contact position after the control power has been removed. Latching relays allow a customer to control a circuit by simply providing a single pulse to the relay control circuit. Latching relays are also desirable when the customer needs to have a relay that maintains its position during an interruption of power.

There are three main types of Latching relays. Magnetic latching, Mechanical Latching and Impulse Sequencing.

## Magnetic Latching Relays

Magnetic Latching relays require one pulse of coil power to move their contacts in one direction, and another, redirected pulse to move them back. Repeated pulses from the same input have no effect. Magnetic Latching relays are useful in applications where interrupted power should not be able to transition the contacts.

Magnetic Latching relays can have either single or dual coils. On a single coil device, the relay will operate in one direction when power is applied with one polarity, and will reset when the polarity is reversed. On a dual coil device, when polarized voltage is applied to the reset coil the contacts will transition. AC controlled magnetic latch relays have single coils that employ steering diodes to differentiate between operate and reset commands.



## Mechanical Latching Relays

Mechanical latching relays use a locking mechanism to hold their contacts in their last set position until commanded to change state, usually by means of energizing a second coil. Since the relay does not rely on a magnet, the locking strength will not degrade over time or weaken during thermal cycling. The contacts will remain locked in the directed position until the opposing coil has been energized. Packaging machinery that places several units into a single container would be a good example.



## Impulse Relays

Impulse relays are a form of latching relay that transfers the contacts with each pulse. Many impulse relays are made up of a magnetic latch relay and a solid state steering circuit that, upon application of power, determines which position the relay is in and energizes the opposite coil. The contacts transfer and hold that position when power is removed. When reenergized, the contacts transfer again and hold that position, and so on. In order to transfer the contacts, one simply provides a single unidirectional pulse. There is no need to redirect the control pulse or reverse the polarity.

Impulse relays can be used as wear equalizers. They are well suited for applications such as turning a single device on or off from one or more locations with a single momentary switch or push button at each station. For example, a conveyor could be started and/or stopped from multiple locations by means of a single button at each position.





### 712 Alternating Relay

In many industrial pumping applications, two identical pumps are used for the same job. A standby unit is available in case the first pump fails. However, a completely idle pump might deteriorate and provide no safety margin. Alternating relays prevent this by assuring that both pumps get equal run time.









The Model 712 Series Alternating Relay is designed for duplex pumping systems where it is desirable to equalize pump run time. The solid state alternating circuit drives an internal electromechanical relay. A continuous power source and control switch is required.

The control switch (float, pressure or other isolated contact) is connected as shown in the respective wiring diagrams. Each time the control switch is opened the output contacts will change status. Indicator lights on the case show the internal relay status.

Setting the top toggle switch to the “center position” alternates the load; while setting the switch to “Load 1” or “Load 2” will lock the relay in the respected position, preventing alternation.

The alternating relay approach isn’t limited to pumping applications. The control switches could be thermostats or pressure switches, and the loads could be fans or compressors.

### Applications:

<b>INDUSTRIAL AUTOMATION</b> 	<b>INDUSTRIAL APPLIANCES</b> 	<b>PACKING MACHINES</b> 	<b>PUMPING MACHINES</b> 	<b>COMPRESSORS</b> 	<b>INDUSTRIAL FANS</b> 
-------------------------------------------------------------------------------------------------------------------------	-------------------------------------------------------------------------------------------------------------------------	--------------------------------------------------------------------------------------------------------------------	--------------------------------------------------------------------------------------------------------------------	-------------------------------------------------------------------------------------------------------------	---------------------------------------------------------------------------------------------------------------------

## Advantages of the 712 Alternating Relay

### The Complete System Solution!



**Highest Grade Electronic Components**  
RoHS Compliant.

The Model 712 series Alternating Relay is designed for duplex pumping systems where it is desirable to equalize pump run time. The solid state alternating circuit drives an internal electromechanical relay. A continuous power source and control switch are required.

The control switch (float, pressure or other isolated contact) is connected between the L1 terminal and the control terminal. Each time the control switch is opened the output contacts will change status. Indicator lights on the case show the internal relay status.

Setting the top toggle switch to Load 1 or Load 2 will lock the relay in position, preventing alternation.

**UL Listed when 712 Relay and Octal Socket are Combined**  
UL Approved for Field Replacement.

- Offers a "one stop solution" for your pump management system.
- Several configurations available to meet your individual needs.
- Switching capabilities up to 12 amps.
- Two LED status indicators; indicate status of the separate loads independently.
- Dual Voltage Coils eliminate the need to specify AC or DC (AC only for 240 volts).
- Only 36 mm's wide; does not take up any additional room on the DIN rail.
- Color and appearance designed for high visibility in all environments.
- Engineering availability allows for customized control system solutions.



See Section 3 p.14-16



**16-711C1  
FLANGE ADAPTER**



**16-711C4  
DIN RAIL ADAPTER**

# 712 Alternating Relay/DPDT, 12 Amp Rating

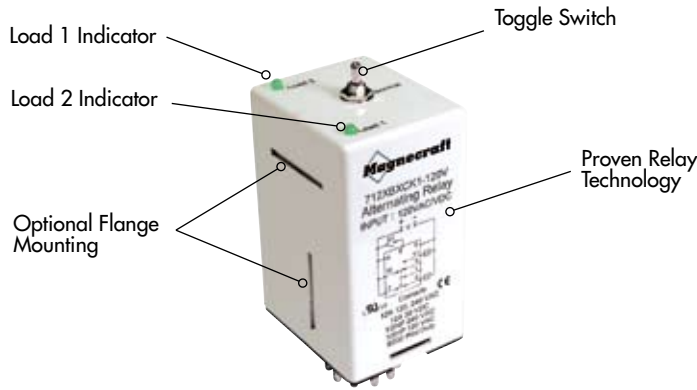

712 Relay with the 70-750DL8-1 Socket

## General Specifications (UL 508)

Contact Characteristics		Units	712XAXC	712XBXC	712XBXCX	712XBXCX1
Number and type of Contacts			SPDT	DPDT CROSS WIRED	DPDT, PIN 9 - NO PIN 11 - NC	DPDT, PIN 9 - NC PIN 11 - NO
Contact materials			Silver Alloy			
Thermal (Carrying) Current		A	12			
Maximum Switching Voltage		V	300			
Current rating		Resistive	12A @ 240V 50/60Hz			
Switching voltage		Resistive	12A @ 30V			
		HP	1/3 @ 120 VAC			
		HP	1/2 @ 240 VAC			
Minimum Switching Requirement		Pilot Duty mA	B300 100 @ 5 VDC (.5W)			
Coil Characteristics						
Voltage Range		V	12, 24, 120 240			
Operating Range		% of Nominal	80% to 110% 80% to 110%			
Average consumption		W	1.8			
Drop-out voltage threshold		V	1.8			
		VDC	15% 10%			
Timing Characteristics						
Time Delay - Fixed		s	0.5			
Reset Time		ms	100			
Alternating Action		Maximum	Release of Control Switch			
Performance Characteristics						
Electrical Life (UL 508)		(Resistive)	100,000			
Mechanical Life		Operations @ Rated Current	10,000,000			
Rated insulation voltage		Unpowered	1500			
Dielectric strength		Between coil and contact	500			
rms voltage		Between poles	1500			
		Between contacts				
Environment						
Product certifications			UR, CSA, CE			
Ambient air temperature		Standard version	°C -30...+70			
around the device		Storage	°C -20...+60			
Degree of protection		Operation	IP 40			
Weight		grams	120			

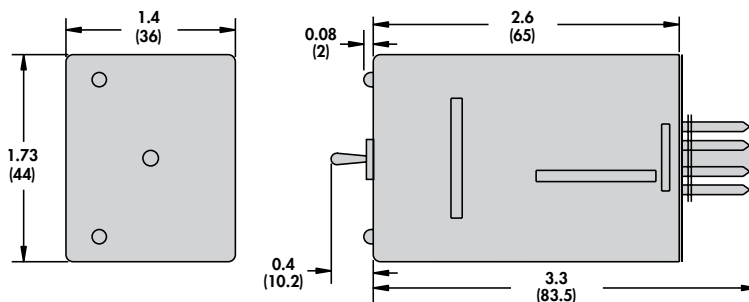

**Standard Part Numbers**

**BOLD-FACED PART NUMBERS ARE NORMALLY STOCKED**

Part Numbers	Input Voltage	Timing Range	Contact Configuration	Rated Load Current
8 Pin Octal Base, SPDT				
712XAXC-12V	12 VAC/VDC	0.5s Fixed	SPDT	12 Amps
712XAXC-24V	24 VAC/VDC	0.5s Fixed	SPDT	12 Amps
<b>712XAXC-120V</b>	120 VAC/VDC	0.5s Fixed	SPDT	12 Amps
712XAXC-240A	240 VAC	0.5s Fixed	SPDT	12 Amps
8 Pin Octal Base, DPDT (CROSS WIRED)				
712XBXC-12V	12 VAC/VDC	0.5s Fixed	DPDT	12 Amps
712XBXC-24V	24 VAC/VDC	0.5s Fixed	DPDT	12 Amps
<b>712XBXC-120V</b>	120 VAC/VDC	0.5s Fixed	DPDT	12 Amps
712XBXC-240A	240 VAC	0.5s Fixed	DPDT	12 Amps
11 Pin Octal Base, DPDT (PIN 11 NC)				
712XBCK-12V	12 VAC/VDC	0.5s Fixed	DPDT	12 Amps
712XBCK-24V	24 VAC/VDC	0.5s Fixed	DPDT	12 Amps
<b>712XBCK-120V</b>	120 VAC/VDC	0.5s Fixed	DPDT	12 Amps
712XBCK-240A	240 VAC	0.5s Fixed	DPDT	12 Amps
11 Pin Octal Base, DPDT (PIN 11 NO)				
712XBCK1-12V	12 VAC/VDC	0.5s Fixed	DPDT	12 Amps
712XBCK1-24V	24 VAC/VDC	0.5s Fixed	DPDT	12 Amps
<b>712XBCK1-120V</b>	120 VAC/VDC	0.5s Fixed	DPDT	12 Amps
712XBCK1-240A	240 VAC	0.5s Fixed	DPDT	12 Amps

**Part Number Builder**

Series	Contact Configuration	Pin Orientation	-	Input Voltage
712	XAX = SPDT	C = 8 OCTAL	-	12V = 12 VAC/VDC
	XBX = DPDT	CK = 11 PIN OCTAL (PIN 11 NC)		24V = 24 VAC/VDC
		CK1 = 11 PIN OCTAL (PIN 11 NO)		120V = 120 VAC/VDC
				240V = 240 VAC

Other mating sockets see Section 2: 70-750DL11-1, 70-750E8-1, 70-750E11-1, 70-464-1, 70-465-1, 70-169-1, 70-170-1

**Relay Adapters**



**16-711C4**  
Section 3, p.14-16



**16-711C1**  
Section 3, p.14-16

