

I.D. Tag/Write-On Plastic Labels

NEW

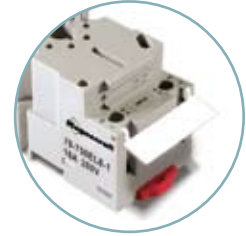

SECTION 3

Characteristics	16-700ST-1*	16-782FT-1	16-750/788FT-1
Description	Write-On Plastic Label *for 16-782PC-1 Clip	Write-On Plastic Label for Sockets	Write-On Plastic Label for Sockets
Function	Identification of Relays in Multi-Relay Apps.	Identification of Circuits in Multi-Relay Apps.	Identification of Circuits in Multi-Relay Apps.
Packaging Minimum	Tear-off card/108 pieces	10 pieces	10 pieces
Used with these Sockets			
	70-782D14-1 (Sec. 2, p.22-23)	70-782EL8-1 (Sec. 2, p.14-15)	70-750E8-1 (Sec. 2, p.28-29)
	70-782EL8-1 (Sec. 2, p.14-15)	70-782EL11-1 (Sec. 2, p.16-17)	70-750E11-1 (Sec. 2, p.28-29)
	70-782EL11-1 (Sec. 2, p.16-17)	70-782EL14-1 (Sec. 2, p.18-19)	70-750EL8-1 (Sec. 2, p.26-27)
	70-782EL14-1 (Sec. 2, p.18-19)	70-782E14-1 (Sec. 2, p.20-21)	70-750EL11-1 (Sec. 2, p.26-27)
	70-782E14-1 (Sec. 2, p.20-21)		70-788EL11-1 (Sec. 2, p.24-25)

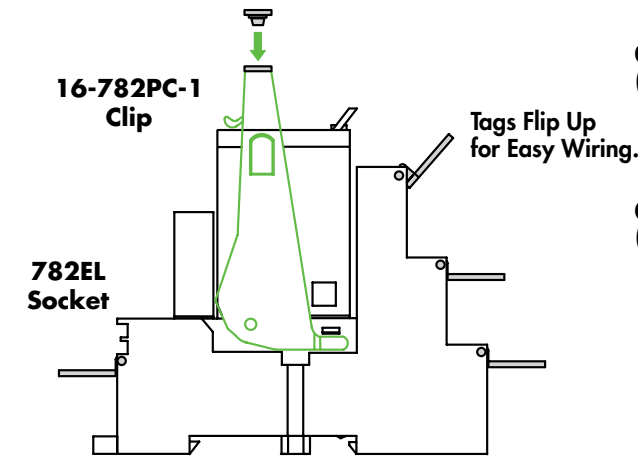

16-700ST-1

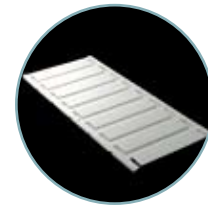
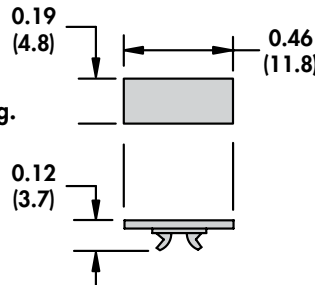

Note:
16-782ST plastic label sold as a 108 piece tear-off card.

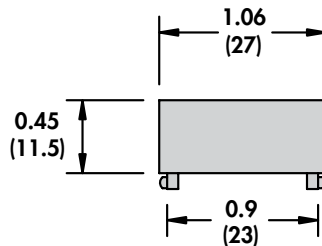
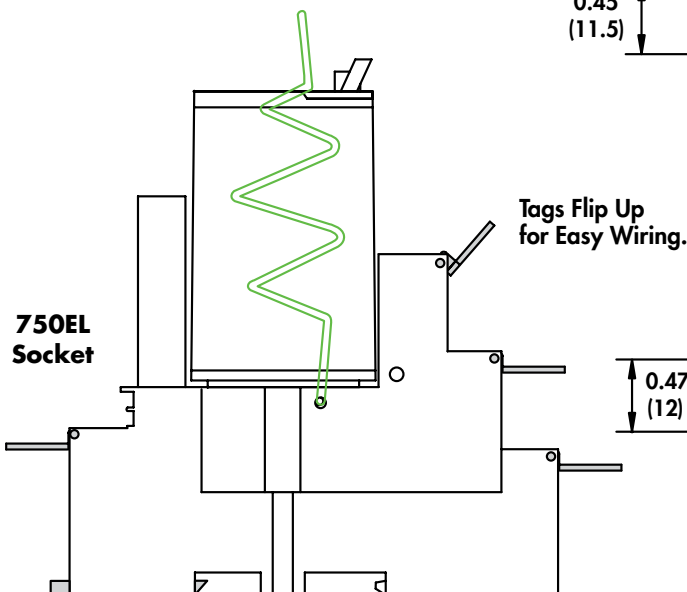

16-782FT-1

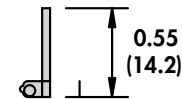

Note:
16-782FT and the 16-750/788FT plastic labels sold as a 10 piece package.

16-750/788FT-1

