

KEMET's High Voltage Surface Mount Capacitors are designed to withstand high voltage applications. They offer high capacitance with low leakage current and low ESR at high frequency. The capacitors have pure tin (Sn) plated external electrodes for good solderability. X7R dielectrics are not designed for AC line filtering applications. An insulating coating may be required to prevent surface arcing. These components are RoHS compliant.

## APPLICATIONS

- Switch Mode Power Supply
  - Input Filter
  - Resonators
  - Tank Circuit
  - Snubber Circuit
  - Output Filter
- High Voltage Coupling
- High Voltage DC Blocking
- Lighting Ballast
- Voltage Multiplier Circuits
- Coupling Capacitor/CUK

## MARKETS

- Power Supply
- High Voltage Power Supply
- DC-DC Converter
- LCD Fluorescent Backlight Ballast
- HID Lighting
- Telecommunications Equipment
- Industrial Equipment/Control
- Medical Equipment/Control
- Computer (LAN/WAN Interface)
- Analog and Digital Modems
- Automotive

## OUTLINE DRAWING

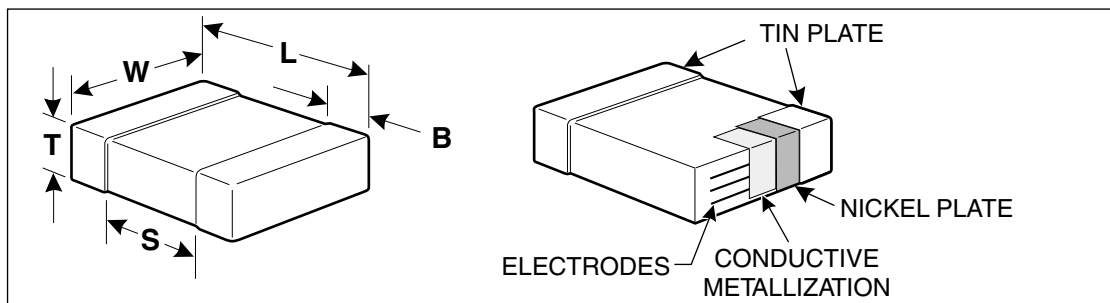

**TABLE 1 - DIMENSIONS - MILLIMETERS (in.)**

Metric Code	EIA Size Code	L - Length	W - Width	B - Bandwidth	Band Separation
2012	0805	2.0 (0.079) ± 0.2 (0.008)	1.2 (0.049) ± 0.2 (0.008)	0.5 (0.02) ±0.25 (0.010)	0.75 (0.030)
3216	1206	3.2 (0.126) ± 0.2 (0.008)	1.6 (0.063) ± 0.2 (0.008)	0.5 (0.02) ± 0.25 (0.010)	N/A
3225	1210	3.2 (0.126) ± 0.2 (0.008)	2.5 (0.098) ± 0.2 (0.008)	0.5 (0.02) ± 0.25 (0.010)	N/A
4520	1808	4.5 (0.177) ± 0.3 (0.012)	2.0 (0.079) ± 0.2 (0.008)	0.6 (0.024) ± 0.35 (0.014)	N/A
4532	1812	4.5 (0.177) ± 0.3 (0.012)	3.2 (0.126) ± 0.3 (0.012)	0.6 (0.024) ± 0.35 (0.014)	N/A
4564	1825	4.5 (0.177) ± 0.3 (0.012)	6.4 (0.250) ± 0.4 (0.016)	0.6 (0.024) ± 0.35 (0.014)	N/A
5650	2220	5.6 (0.224) ± 0.4 (0.016)	5.0 (0.197) ± 0.4 (0.016)	0.6 (0.024) ± 0.35 (0.014)	N/A
5664	2225	5.6 (0.224) ± 0.4 (0.016)	6.4 (0.250) ± 0.4 (0.016)	0.6 (0.024) ± 0.35 (0.014)	N/A

Ceramic Surface Mount

**C0G DIELECTRIC CAPACITANCE VALUES AND THICKNESS TARGETS (in.)**

Cap pF	Capacitance Tolerance *	Series	0805		1206			1210			1808			1812			1825			2220			2225		
		Max Thickness (in)	0.050	0.050	0.065	0.065	0.065	0.065	0.065	0.065	0.065	0.065	0.067	0.067	0.067	0.067	0.067	0.067	0.067	0.067	0.067	0.067	0.067		
		Cap Code/ Voltage	500	1000	500	1000	1500	2000	500	1000	1500	2000	500	1000	1500	2000	2500	3000	500	1000	1500	2000	2500	3000	
10-24	C,D																								
2.7-5.1	C,D	K,M	279-519																						
5.6-9.1	C,D	J,K,M	569-919																						
10	C,D	J,K,M	100																						
11	C,D	J,K,M	110																						
12	C,D	J,K,M	120																						
13	C,D	J,K,M	130																						
15	C,D	G,J,K,M	150																						
16	C,D	G,J,K,M	160																						
18	C,D	G,J,K,M	180																						
20	C,D	G,J,K,M	200																						
22	C,D	G,J,K,M	220																						
24	C,D	G,J,K,M	240																						
27	D,F,G,J,K,M		270																						
30	D,F,G,J,K,M		300																						
33	D,F,G,J,K,M		330																						
36	D,F,G,J,K,M		360																						
39	D,F,G,J,K,M		390																						
43	D,F,G,J,K,M		430																						
47	D,F,G,J,K,M		470																						
51	D,F,G,J,K,M		510																						
56	F,G,J,K,M		560																						
62	F,G,J,K,M		620																						
68	F,G,J,K,M		680																						
75	F,G,J,K,M		750																						
82	F,G,J,K,M		820																						
91	F,G,J,K,M		910																						
100	F,G,J,K,M		101																						
110	F,G,J,K,M		111																						
120	F,G,J,K,M		121																						
130	F,G,J,K,M		131																						
150	F,G,J,K,M		151																						
160	F,G,J,K,M		161																						
180	F,G,J,K,M		181																						
200	F,G,J,K,M		201																						
220	F,G,J,K,M		221																						
240	F,G,J,K,M		241																						
270	F,G,J,K,M		271																						
300	F,G,J,K,M		301																						
330	F,G,J,K,M		331																						
360	F,G,J,K,M		361																						
390	F,G,J,K,M		391																						
430	F,G,J,K,M		431																						
470	F,G,J,K,M		471																						
510	F,G,J,K,M		511																						
560	F,G,J,K,M		561																						
620	F,G,J,K,M		621																						
680	F,G,J,K,M		681																						
750	F,G,J,K,M		751																						
820	F,G,J,K,M		821																						
910	F,G,J,K,M		911																						
1000	F,G,J,K,M		102																						
1100	F,G,J,K,M		112																						
1200	F,G,J,K,M		122																						
1300	F,G,J,K,M		132																						
1500	F,G,J,K,M		152																						
1600	F,G,J,K,M		162																						
1800	F,G,J,K,M		182																						
2000	F,G,J,K,M		202																						
2200	F,G,J,K,M		222																						
2400	F,G,J,K,M		242																						
2700	F,G,J,K,M		272																						
3000	F,G,J,K,M		302																						
3300	F,G,J,K,M		332																						
3600	F,G,J,K,M		362																						
3900	F,G,J,K,M		392																						
4300	F,G,J,K,M		432																						
4700	F,G,J,K,M		472																						
5100	F,G,J,K,M		512																						
5600	F,G,J,K,M		562																						
6200	F,G,J,K,M		622																						
6800	F,G,J,K,M		682																						
7500	F,G,J,K,M		752																						
8200	F,G,J,K,M		822																						
9100	F,G,J,K,M		912																						
10,000	F,G,J,K,M		103																						

\* Contact KEMET Sales Representative for C, D, F & G Capacitance Tolerance availability.

Note: Actual thickness dimensions may be less than stated maximum. Check the KEMET website, [www.kemet.com](http://www.kemet.com), for additional values and chip sizes available.



## CAPACITOR ORDERING INFORMATION

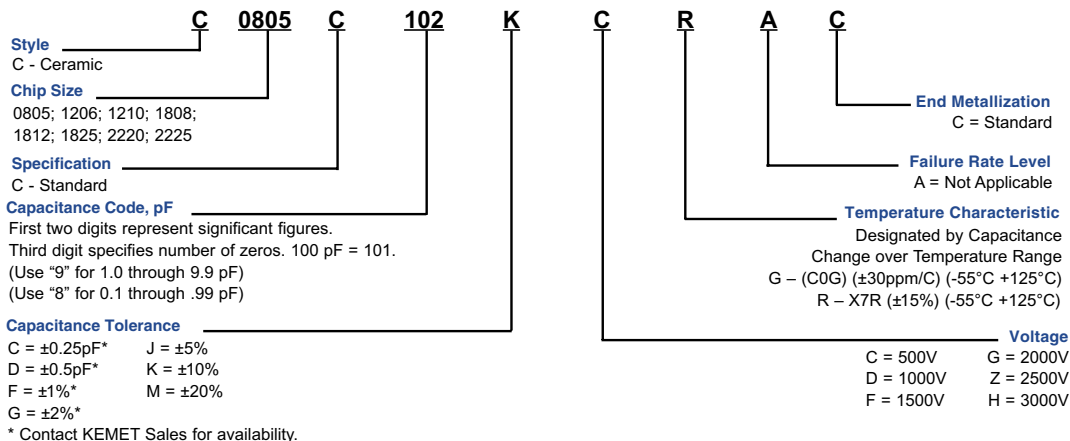

## ELECTRICAL PARAMETERS

Property	Specification
Capacitance	C0G: 1 pF to 0.010 µF X7R: 10 pF to 0.22 µF 25°C, 1.0 ± 0.2 Vrms, 1 kHz (1 MHz for ≤ 1000 pF (C0G only))
Cap Tolerance	C0G: C*, D*, F*, G*, J, K, M * Contact KEMET Sales for availability. X7R: J, K, M
DF	C0G: 0.1% Max X7R: 2.5% Max
Voltage Ratings	500 V, 1000 V, 1500 V, 2000 V, 2500 V, 3000 V
Operating Temperature Range	From -55°C to +125°C
25°C IR @ 500V	100 GΩ or 1000 MΩ-µF, whichever is less
125°C IR @ 500V	10 GΩ or 100 MΩ-µF, whichever is less
-55°C TCC +125°C TCC	X7R: ± 15% C0G: ± 30 ppm / °C
Dielectric Strength	150% of Rated Voltage for Rated Voltage <1000 V 120% of Rated Voltage for Rated Voltage ≥1000V
Ripple Current	Consult KEMET Sales Representative

## MARKING

These chips are supplied unmarked. If required, they can be supplied LASER-marked at an extra cost. Details on the marking format is located on page 97.

## PACKAGING

KEMET High Voltage Surface Mount MLCC are available packaged in tape and reel configuration, or bulk bag as outlined on page 83. Please consult factory for waffle packaging options.

## SOLDERING PROCESS

The 0805 and 1206 case sizes are suitable for either reflow or wave soldering processes. Sizes 1210 and larger should be limited to reflow soldering only. All sizes incorporate the standard KEMET barrier layer of pure nickel with an overplating of pure tin (Sn) for excellent solderability and resistance to solder leaching of the termination.

## RECOMMENDED SOLDER PAD DIMENSIONS

Chip Size	T (Total Length)		S (Separation)		W (Pad Width)		L (Pad Length)	
	mm	in.	mm	in.	mm	in.	mm	in.
0805	3.30	0.130	0.70	0.028	1.60	0.063	1.30	0.051
1206	4.50	0.177	1.50	0.059	2.00	0.079	1.50	0.059
1210	4.50	0.177	1.50	0.059	2.90	0.114	1.50	0.059
1808	5.90	0.232	2.30	0.091	2.40	0.094	1.80	0.071
1812	5.90	0.232	2.30	0.091	3.70	0.146	1.80	0.071
1825	5.90	0.232	2.30	0.091	6.90	0.272	1.80	0.071
2220	7.00	0.276	3.30	0.130	5.50	0.217	1.85	0.073
2225	7.00	0.276	3.30	0.130	6.80	0.268	1.85	0.073

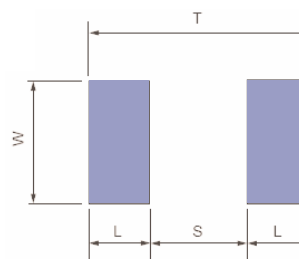

### Tape & Reel Packaging

KEMET offers Multilayer Ceramic Chip Capacitors packaged in 8mm and 12mm plastic tape on 7" and 13" reels in accordance with EIA standard 481-1: Taping of surface mount components for automatic handling. This packaging system is compatible with all tape fed automatic pick and place systems. See page 78 for details on reeling quantities for commercial chips and page 87 for MIL-PRF-55681 chips.

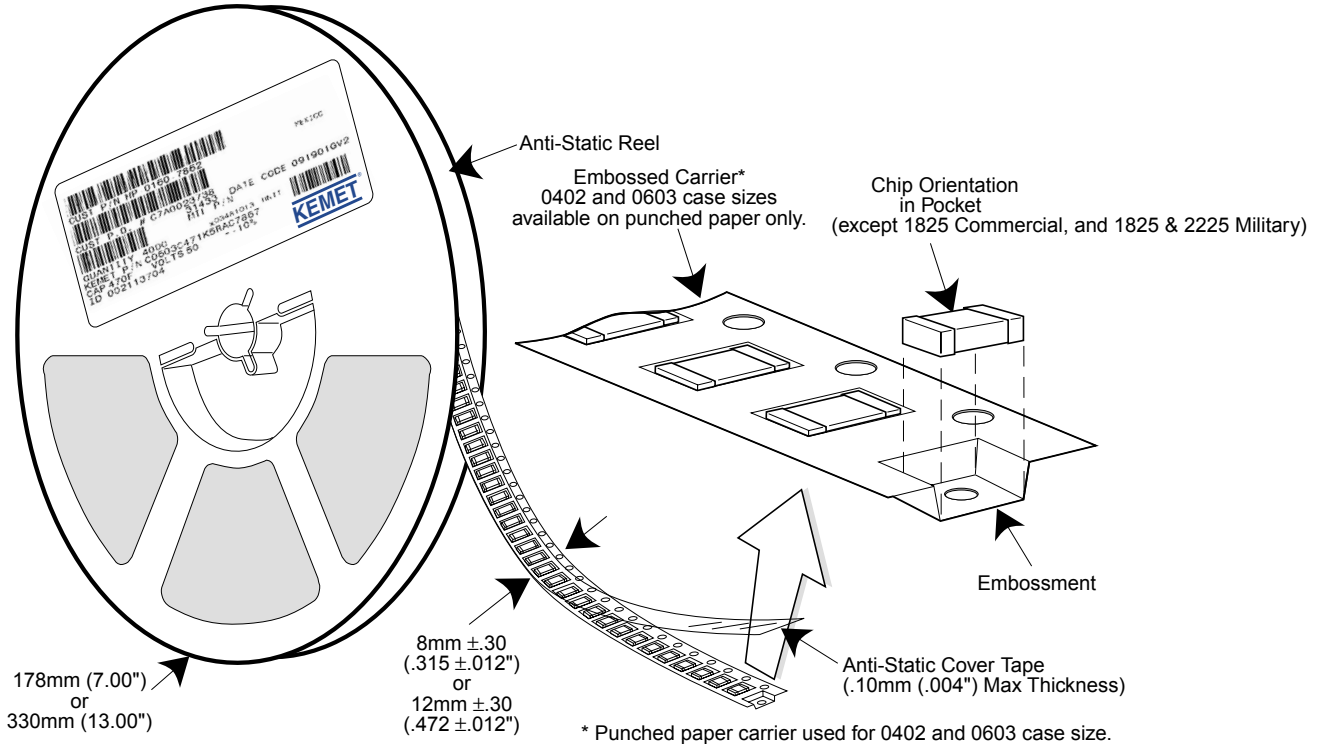

### SURFACE MOUNT LAND DIMENSIONS - CERAMIC CHIP CAPACITORS - MM

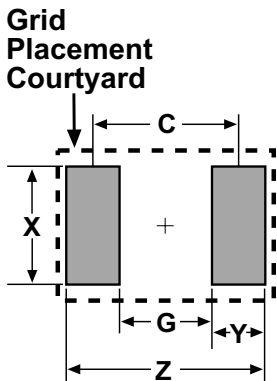

Dimension	Reflow Solder					Wave Solder				
	Z	G	X	Y(ref)	C(ref)	Z	G	X	Y(ref)	Smin
0402	2.14	0.28	0.74	0.93	1.21	Not Recommended				
0603	2.78	0.68	1.08	1.05	1.73	3.18	0.68	0.80	1.25	1.93
0805	3.30	0.70	1.60	1.30	2.00	3.70	0.70	1.10	1.50	2.20
1206	4.50	1.50	2.00	1.50	3.00	4.90	1.50	1.40	1.70	3.20
1210	4.50	1.50	2.90	1.50	3.00	4.90	1.50	2.00	1.70	3.20
1812	5.90	2.30	3.70	1.80	4.10	Not Recommended				
1825	5.90	2.30	6.90	1.80	4.10					
2220	7.00	3.30	5.50	1.85	5.15					
2225	7.00	3.30	6.80	1.85	5.15					

Calculation Formula  
 $Z = Lmin + 2Jt + Tt$   
 $G = Smax - 2Jh - Th$   
 $X = Wmin + 2Js + Ts$   
 Tt, Th, Ts = Combined tolerances



## Packaging Information

### Embossed Carrier Tape Configuration (cont.)



### Sketch D: Tape Camber (Top View)



**Figure 2:** Tape Leader & Trailer Dimensions (Metric Dimensions Will Govern)

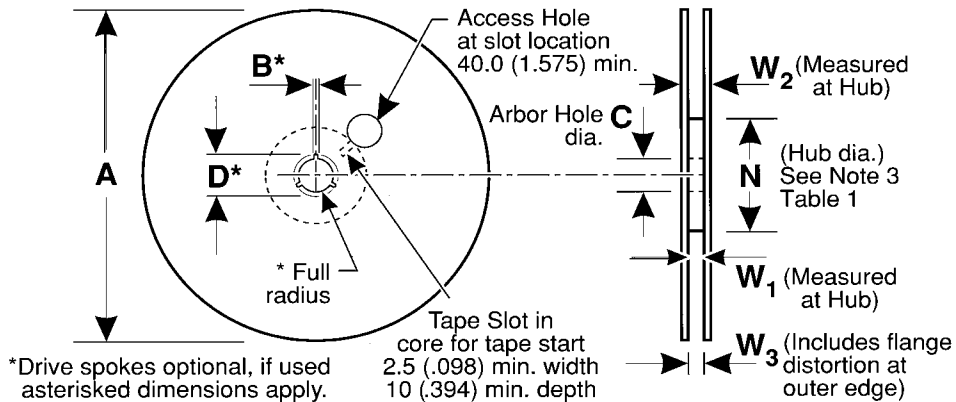
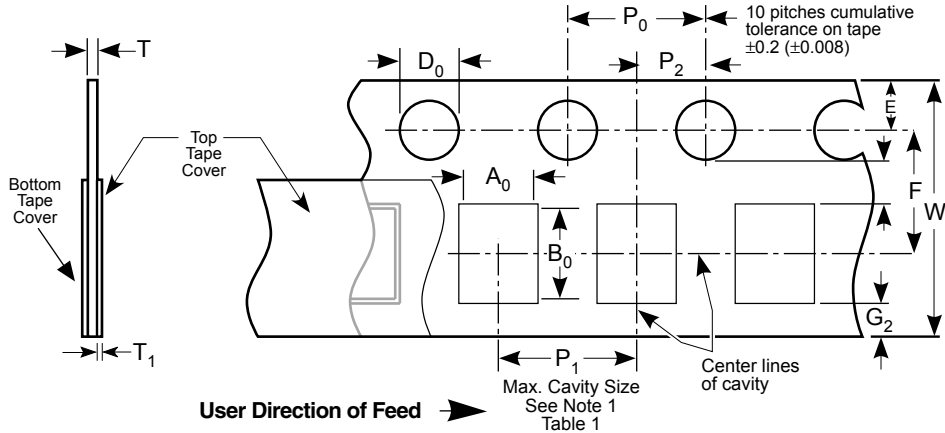

**Figure 3:** Reel Dimensions (Metric Dimensions will govern)

**Table 2 – REEL DIMENSIONS (Metric will govern)**

Tape Size	A Max	B* Min	C	D* Min	N Min	W <sub>1</sub>	W <sub>2</sub> Max	W <sub>3</sub>
8 mm	330.0 (12.992)	1.5 (0.059)	13.0 ± 0.20 (0.512 ± 0.008)	20.2 (0.795)	50.0 (1.969) See Note 3 Table 1	8.4 +1.5, -0.0 (0.331 +0.059, -0.0)	14.4 (0.567)	7.9 Min (0.311) 10.9 Max (0.429)
12 mm	330.0 (12.992)	1.5 (0.059)	13.0 ± 0.20 (0.512 ± 0.008)	20.2 (0.795)	Table 1	12.4 +2.0, -0.0 (0.488 +0.078, -0.0)	18.4 (0.724)	11.9 Min (0.469) 15.4 Max (0.606)

### Punched Carrier (Paper Tape) Configuration (Ceramic Chips Only):



**Table 1: 8 & 12mm Punched Tape**  
(Metric Dimensions Will Govern)

**Constant Dimensions - Millimeters (Inches)**

Tape Size	D <sub>0</sub>	E	P <sub>0</sub>	P <sub>2</sub>	T <sub>1</sub>	G <sub>1</sub>	G <sub>2</sub>	R Min.
8mm and 12mm	1.5 +0.10, -0.0 (.059 +0.004, -0.0)	1.75 ±0.10 (.069 ±0.004)	4.0 ± 0.10 (.157 ± 0.004)	2.0 ± 0.05 (.079 ± 0.002)	0.10 (.004) Max.	0.75 (.030) Min.	0.75 (.030) Min.	25 (.984) See Note 2 Table 1

**Table 1: 8 & 12mm Punched Tape**  
(Metric Dimensions Will Govern)

**Variable Dimensions - Millimeters (Inches)**

Tape Size	P <sub>1</sub>	F	W	A <sub>0</sub> B <sub>0</sub>	T
8mm 1/2 Pitch	2.0 ± 0.10 (.079 ± .004) See Requirements Section 3.3 (d)	3.5 ± 0.05 (.138 ± .002)	8.0 ± 0.3 (.315 ± 0.012)	See Note 1 Table 1	1.1mm (.043) Max. for Paper Base Tape and 1.6mm (.063) Max. for Non- Paper Base Compositions. See Note 3.
8mm	4.0 ± 0.10 (0.157 ± .004)				
12mm	4.0 ± 0.10 (0.157 ± .004)	5.5 ± 0.05 (.217 ± .002)	12.0 ± 0.3 (.472 ± .012)		
12mm Double Pitch	8.0 ± 0.10 (0.315 ± .004)				

**Note:**

1. A<sub>0</sub>, B<sub>0</sub> and T determined by the maximum dimensions to the ends of the terminals extending from the body and/or the body dimensions of the component. The clearance between the ends of the terminals or body of the component to the sides and depth of the cavity (A<sub>0</sub>, B<sub>0</sub> and T) must be within 0.05mm (.002) minimum and 0.50mm (.020) maximum. The clearance allowed must also prevent rotation of the component within the cavity of not more than 20 degrees (see sketches A and B).
2. Tape with components shall pass around radius "R" without damage.
3. KEMET nominal thicknesses are: 0402 = 0.6mm and all others 0.95mm minimum.

**Sketch A:**  
Bending Radius  
See Note 2  
Table 1

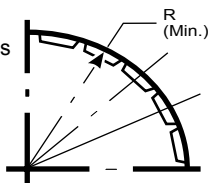

**Sketch B:**  
Max. Component  
Rotation - Front  
Cross Sectional View

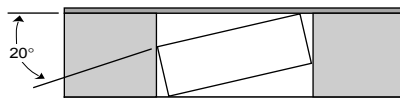

**Sketch C:**  
Component Rotation - Top View

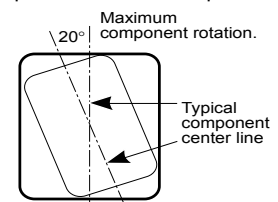



### Bulk Cassette Packaging (Ceramic Chips only) (Meets Dimensional Requirements IEC-286-6 and EIAJ 7201)

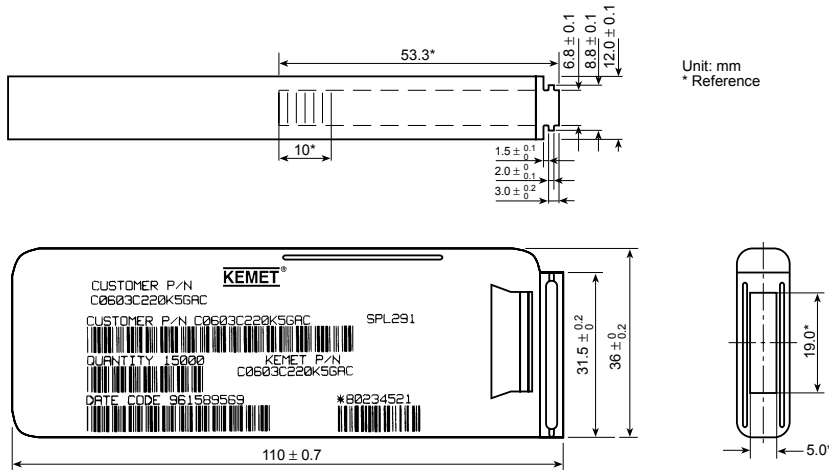

### Table 2 – Capacitance Values Available In Bulk Cassette Packaging

Case Size	Dielectric	Voltage	Min. Cap Value	Max. Cap Value
0402	All	All	All	All
0603	All	All	All	All
0805	C0G	200	109	181
		100	109	331
		50	109	102
	X7R	200	221	392
		100	221	103
		50	221	273
		25	221	104
		16	221	104
	Y5V	25	104	224
16		104	224	

### Table 1 – Capacitor Dimensions for Bulk Cassette Packaging – Millimeters

Metric Size Code	EIA Size Code	Length L	Width W	Thickness T	Bandwidth B	Minimum Separation S	Number of Pcs/Cassette
1005	0402	1.0 ± 0.05	0.5 ± 0.05	0.5 ± .05	0.2 to 0.4	0.3	50,000
1608	0603	1.6 ± 0.07	0.8 ± 0.07	0.8 ± .07	0.2 to 0.5	0.7	15,000
2012	0805	2.0 ± 0.10	1.25 ± 0.10	0.6 ± .10	0.5 to 0.75	0.75	10,000

Terminations: KEMET nickel barrier layer with a tin overplate.

### CAPACITOR MARKING TABLE (Marking Optional - Not Available for 0402 Size or Y5V Dielectric)

Alpha Character	Capacitance (pF) For Various Numerical Identifiers						
	9	0	1	2	3	4	5
A	0.10	1.0	10	100	1000	10,000	100,000
B	0.11	1.1	11	110	1100	11,000	110,000
C	0.12	1.2	12	120	1200	12,000	120,000
D	0.13	1.3	13	130	1300	13,000	130,000
E	0.15	1.5	15	150	1500	15,000	150,000
F	0.16	1.6	16	160	1600	16,000	160,000
G	0.18	1.8	18	180	1800	18,000	180,000
H	0.20	2.0	20	200	2000	20,000	200,000
J	0.22	2.2	22	220	2200	22,000	220,000
K	0.24	2.4	24	240	2400	24,000	240,000
L	0.27	2.7	27	270	2700	27,000	270,000
M	0.30	3.0	30	300	3000	30,000	300,000
N	0.33	3.3	33	330	3300	33,000	330,000
P	0.36	3.6	36	360	3600	36,000	360,000
Q	0.39	3.9	39	390	3900	39,000	390,000
R	0.43	4.3	43	430	4300	43,000	430,000
S	0.47	4.7	47	470	4700	47,000	470,000
T	0.51	5.1	51	510	5100	51,000	510,000
U	0.56	5.6	56	560	5600	56,000	560,000
V	0.62	6.2	62	620	6200	62,000	620,000
W	0.68	6.8	68	680	6800	68,000	680,000
X	0.75	7.5	75	750	7500	75,000	750,000
Y	0.82	8.2	82	820	8200	82,000	820,000
Z	0.91	9.1	91	910	9100	91,000	910,000
a	0.25	2.5	25	250	2500	25,000	250,000
b	0.35	3.5	35	350	3500	35,000	350,000
d	0.40	4.0	40	400	4000	40,000	400,000
e	0.45	4.5	45	450	4500	45,000	450,000
f	0.50	5.0	50	500	5000	50,000	500,000
m	0.60	6.0	60	600	6000	60,000	600,000
n	0.70	7.0	70	700	7000	70,000	700,000
t	0.80	8.0	80	800	8000	80,000	800,000
y	0.90	9.0	90	900	9000	90,000	900,000

Laser marking is available as an extra-cost option for most KEMET ceramic chips. Such marking is two sided, and includes a  $\bar{K}$  to identify KEMET, followed by two characters (per EIA-198 - see table below) to identify the capacitance value. Note that marking is not available for size 0402 nor for any Y5V chip. In addition, the 0603 marking option is limited to the  $\bar{K}$  only.



Example shown is 1,000 pF capacitor.