

## MSA-2111

### 6V Fixed Gain Amplifier, for 900 MHz Applications

#### Description



Lifecycle status: **Active**

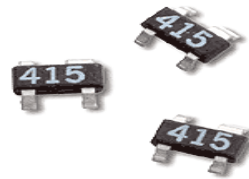

#### Features

The MSA-21 is a 6V cascadable 50ohm gain block targeted for narrow and wide bandwidth IF amplifier applications at 900MHz. It is offered in the SOT-143 surface mount plastic package. Bias: 6V, 29mA;  $f_{3dB} = 0.5\text{GHz}$ ;  $G = 16\text{dB}$ ;  $NF = 3.3\text{dB}$ ;  $P_{1dB} = 10\text{dBm}$ ;  $IP_{3i} = 4\text{dBm}$  all at 900MHz.

# MSA-2111

## Cascadable Silicon Bipolar MMIC Amplifier



### Data Sheet

#### Description

The MSA-2111 is a low cost silicon bipolar Monolithic Microwave Integrated Circuit (MMIC) housed in a surface mount plastic SOT-143 package. This MMIC is designed for use as a general purpose 50  $\Omega$  gain block. Typical applications include narrow and broad band IF and RF amplifiers in commercial and industrial applications.

The MSA-series is fabricated using Avago's 10 GHz  $f_T$ , 25 GHz  $f_{MAX}$ , silicon bipolar MMIC process which uses nitride self-alignment, ion implantation, and gold metallization to achieve excellent performance, uniformity and reliability. The use of an external bias resistor for temperature and current stability also allows bias flexibility.

#### Features

- Cascadable 50  $\Omega$  Gain Block
- Medium Power: 10 dBm at 900 MHz
- High Gain: 16.5 dB Typical at 900 MHz
- Low Noise Figure: 3.3 dB Typical at 900 MHz
- Low Cost Surface Mount Plastic Package
- Tape-and-Reel Packaging Option Available
- Lead-free Option Available

#### SOT-143 Package

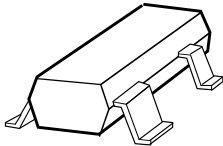

#### Pin Connections and Package Marking

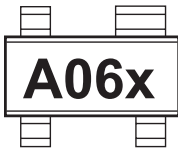

#### Notes:

**Top View. Package Marking provides orientation and identification.**  
"x" is the date code.

#### Typical Biasing Configuration

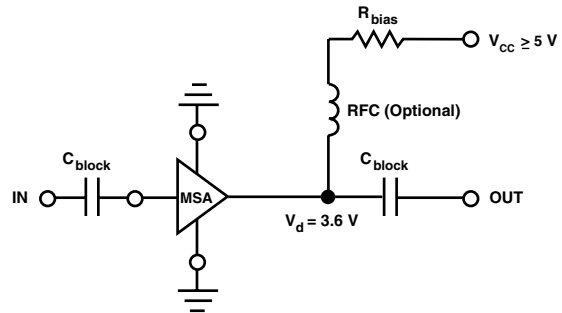

## MSA-2111 Absolute Maximum Ratings

Parameter	Absolute Maximum <sup>[1]</sup>
Device Current	40 mA
Power Dissipation <sup>[2,3]</sup>	125 mW
RF Input Power	+13 dBm
Junction Temperature	150°C
Storage Temperature	-65°C to 150°C

<b>Thermal Resistance<sup>[2]</sup>:</b> $\theta_{jc} = 505^{\circ}\text{C}/\text{W}$
--

### Notes:

1. Permanent damage may occur if any of these limits are exceeded.
2.  $T_{\text{CASE}} = 25^{\circ}\text{C}$ .
3. Derate at 2.0 mW/°C for  $T_{\text{C}} > 85^{\circ}\text{C}$ .

## Electrical Specifications<sup>[1]</sup>, $T_{\text{A}} = 25^{\circ}\text{C}$

Symbol	Parameters and Test Conditions: $I_{\text{d}} = 29 \text{ mA}$ , $Z_0 = 50 \Omega$	Units	Min.	Typ.	Max.
$G_{\text{P}}$	Power Gain ( $ S_{21} ^2$ ) $f = 900 \text{ MHz}$	dB	16.0	17.5	
$\Delta G_{\text{P}}$	Gain Flatness $f = 0.1 \text{ to } 0.3 \text{ GHz}$	dB		$\pm 0.5$	
$f_{3 \text{ dB}}$	3 dB Bandwidth	GHz		0.5	
VSWR	Input VSWR $f = 0.1 \text{ to } 2.5 \text{ GHz}$			1.8:1	
	Output VSWR $f = 0.1 \text{ to } 2.5 \text{ GHz}$			1.8:1	
NF	50 $\Omega$ Noise Figure $f = 900 \text{ MHz}$	dB		3.3	
$P_{1 \text{ dB}}$	Output Power at 1 dB Gain Compression $f = 900 \text{ MHz}$	dBm		10	
$\text{IP}_3$	Third Order Intercept Point $f = 900 \text{ MHz}$	dBm		20	
$t_{\text{D}}$	Group Delay $f = 900 \text{ MHz}$	psec		158	
$V_{\text{d}}$	Device Voltage	V	2.9	3.6	4.3
dV/dT	Device Voltage Temperature Coefficient	mV/°C		-8.0	

### Notes:

1. The recommended operating current range for this device is 12 to 35 mA. Typical gain performance as a function of current is on the following page.

## Ordering Information

Part Numbers	No. of Devices	Comments
MSA-2111-BLK	100	Bulk
MSA-2111-BLKG	100	Bulk
MSA-2111-TR1	3000	7" Reel
MSA-2111-TR1G	3000	7" Reel
MSA-2111-TR2	10000	13" Reel
MSA-2111-TR2G	10000	13" Reel

**Note:** Order part number with a "G" suffix if lead-free option is desired.

## SOT-143 Package Dimensions

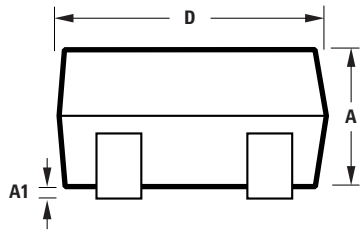
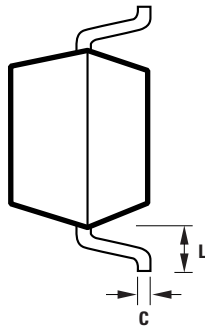
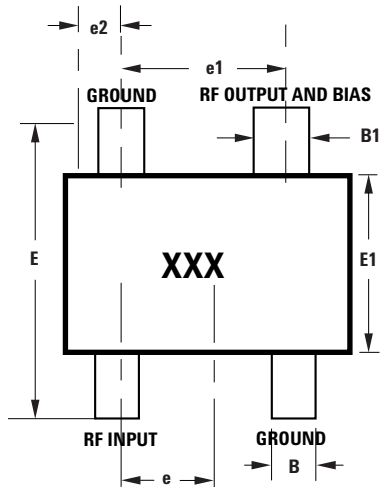

Notes:  
 XXX-package marking  
 Drawings are not to scale

SYMBOL	DIMENSIONS (mm)	
	MIN.	MAX.
A	0.79	1.097
A1	0.013	0.10
B	0.36	0.54
B1	0.76	0.92
C	0.086	0.152
D	2.80	3.06
E1	1.20	1.40
e	0.89	1.02
e1	1.78	2.04
e2	0.45	0.60
E	2.10	2.65
L	0.45	0.69