



PM220-115-1738BT-4 PM220-230-1738BT-4

Features

Size:	172 x 150 x 38 mm
Airflow:	220 CFM
Weight:	930 grams (32 oz)
Noise:	52 dBA
Terminal:	.120 inches
Impeller:	Reinforced Plastic (94V-0)
Frame:	Aluminum Alloy
Bearings:	Sealed Ball

 UL E101153
  CUL E101153

• RoHS Compliant

Dimensions – inches mm

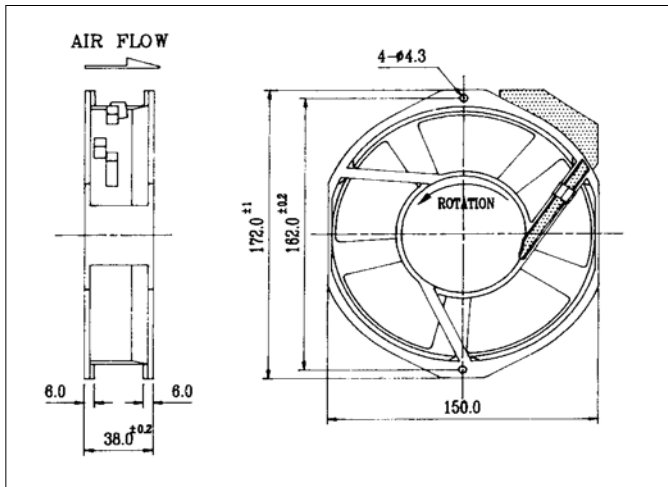

Air Flow vs Air Pressure

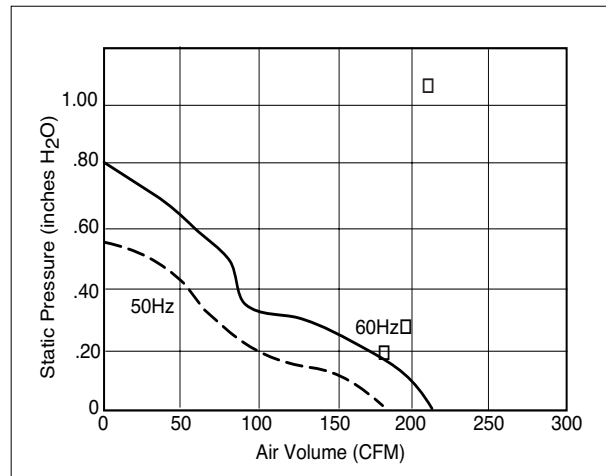

Performance

Type	Rated Voltage (V)	Operating Frequency (Hz)	Input Power (W) (@ 60 Hz)	Max Air Flow (CFM)	Max Air Pressure (In H ₂ O)	Noise* (dBA)	Operating Temperature (°C)	Life Expectancy (Hr) (@ 20 ±15°C)
PM220-115-1738BT-4	115	50/60	32.0	220	0.79/0.83	52	-20~ +85	60,000
PM220-230-1738BT-4	230	50/60	38.0	220	0.79/0.83	52	-20~ +85	60,000

*Measured 1 m from intake

Product specifications contained herein may be changed without prior notice.

It is therefore advisable to contact Purdy Electronics before proceeding with the design of equipment incorporating this product.