

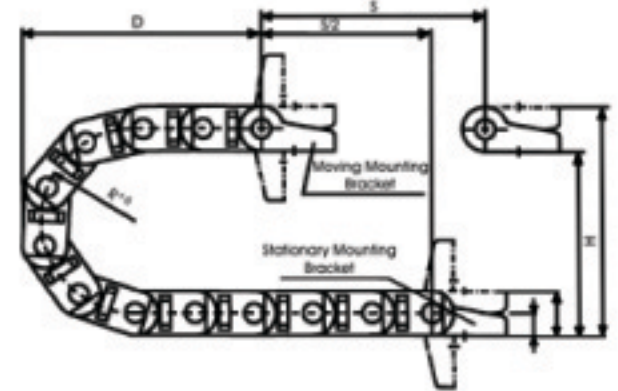

E-Tube R1000: 2480-05-125-0 Inch Version

Inner Width	Outer Width	Radius	Curve Height H	Curve Length K	Weight
2.24 in	2.87 in	4.92 in	11.22 in	18.74 in	0.61 lbs/ft

Operating Space: $H + 1"$ @ 1 lbs/ft



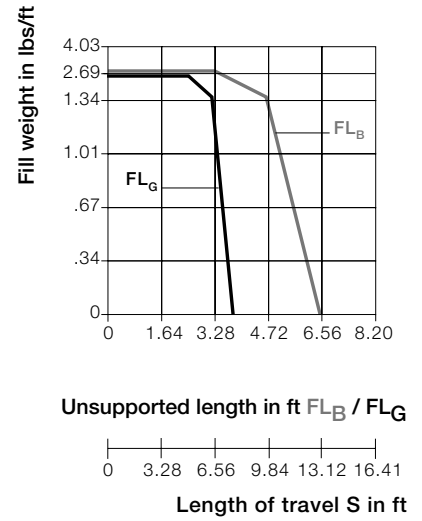
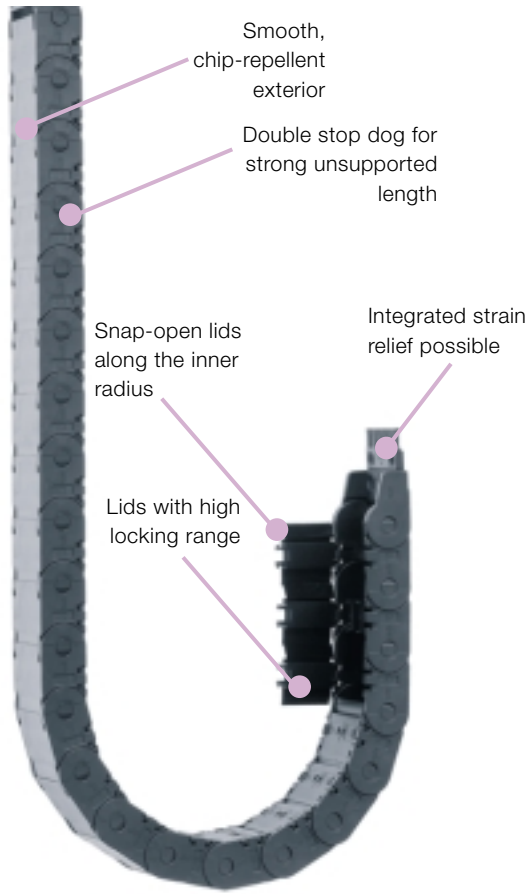

Unsupported length

- FL_B = unsupported with permitted sag
- FL_G = unsupported with straight upper run

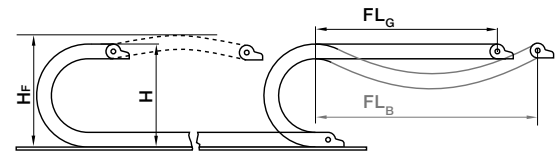

Product Range:

Inner Widths (Bi) inches (mm):	1.50 (38), 2.24 (57), 3.03 (77), 4.06 (103),
Bending Radii (R) inches (mm):	3.94 (100), 4.92 (125), 5.91 (150),
	7.87 (200), 9.84 (250)
Pitch:	1.81 (46 mm)/link = 6.71 links/ft
	(22 links/m) 39.8 (1012 mm)



When to use the Series R157/R158:

- If hinged, snap-open accessibility along inner radius is required
- If a low-cost, lightweight Energy Tube for many types of applications is required
- If flush mounting is required
- If chip-repellent features are required



When not to use the Series R157/R158:

- If snap-open accessibility along both radii is required
 - ▶ System E4/100, Series R770, **Chapter 6**
- If particularly quiet operation is required
 - ▶ Series R58, **Chapter 5**

Series R2480 "E2 Tubes"



R2480

Series R2480 Energy Tube

(hinged, snap-open along the inner radius)

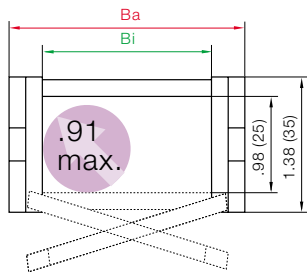

Part No.	Bi	Ba	Bending Radii for ALL Widths	
2480-03	1.50 (038)	2.13 (054)		3.94 (100)
2480-05	2.24 (057)	2.87 (073)		4.92 (125)
2480-07	3.03 (077)	3.66 (093)		5.91 (150)*
2480-10	4.06 (103)	4.69 (119)		7.87 (200)**
				9.84 (250)***

Supplement part number with required radius
for example, 2480-03-100-0

- * Currently NOT available for the 038 width
 - ** Currently ONLY available in the 103 width
 - *** Currently ONLY available in the 038 and 103 widths
- Call igus to check on availability

Installation Dimensions

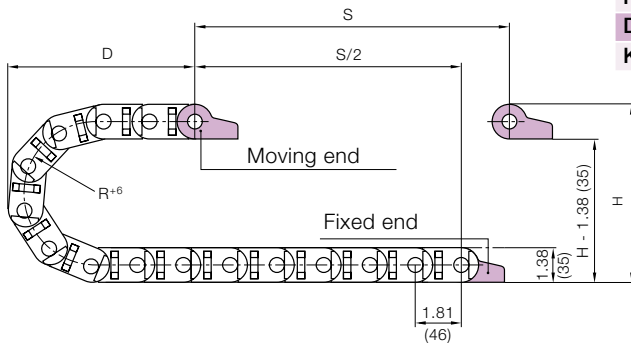

R	3.94 (100)	4.92 (125)	5.91 (150)	7.87 (200)	9.84 (250)
H*) ₀	9.25 (235)	11.22 (285)	13.19 (335)	17.13 (435)	21.06 (535)
D	6.69 (170)	7.68 (195)	8.66 (220)	10.63 (270)	12.60 (320)
K	16.30 (414)	19.53 (496)	22.76 (578)	29.21 (742)	36.22 (920)

*The required clearance height is HF = H + .98 (25) with 1.01 (1.5 kg/m) fill weight. Please consult igus® if space is particularly restricted.

- Pitch: = 1.81 (46 mm) per link
- Links per ft (m): = 6.71 (22)
- Tube length: = $\frac{S}{2} + K$

Interior Separation

Option 1: vertical separators

Vertical separators are used to divide the interior of the Energy Tube. They most commonly perform the tasks of distributing the carrier's fill weight evenly and keeping dissimilar cables/hoses apart. Separators are removable and adjustable for a variety of chamber widths.

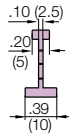

Separators

Unassembled	Part No. 24501
Assembled	Part No. 24511

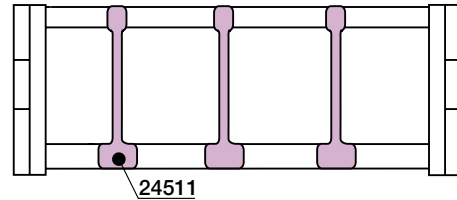

Option 2: full-width shelf

This option is available for the snap-open Series 2480 chains. It is ideal for use in applications involving many thin cables with similar or identical diameters. This shelf slides into place and spans the entire width of the chain.

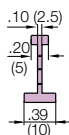

Separators

Unassembled	Part No. 220
Assembled	Part No. 221

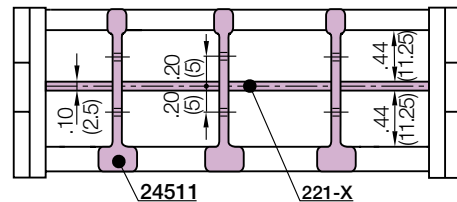

Width X in. (mm)	Part No. Unassembled	Part No. Assembled
1.50 (38)	220-38	221-38
2.24 (57)	220-57	221-57
3.03 (77)	220-77	221-77
4.06 (103)	220-103	221-103



upon request

Order Example and Technical Data: Series R2480 “E2 Tubes”

Order example

2480-10

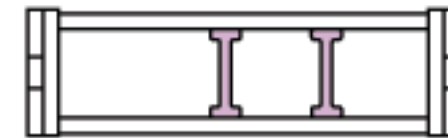
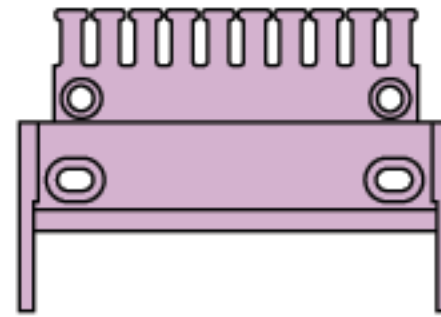
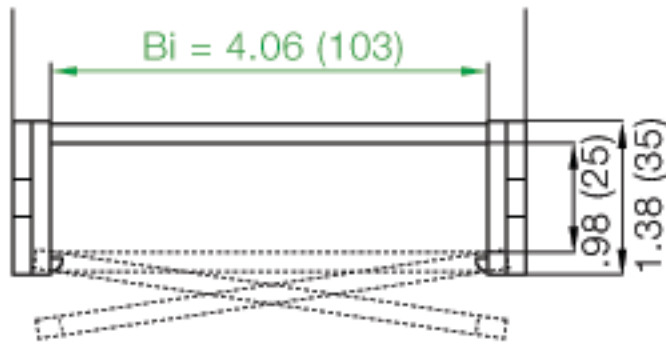

1. Chain selection:

2480-10-100-0

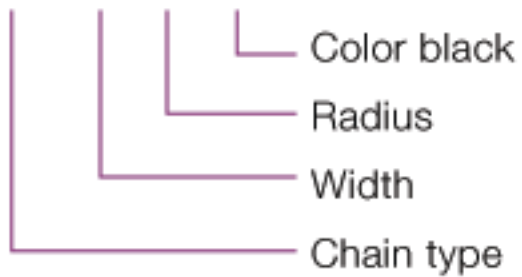

2. Mounting brackets:

2100-34-PZB+

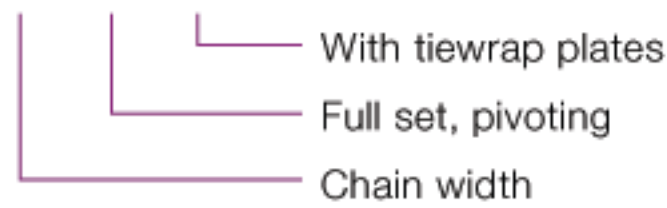

3. Interior separation:

2 separators, unassembled, (Part No. 24501), or assembled every other link (Part No. 24511).
Alternative interior separation configuration according to design layout possible.

4. Additional information on guide troughs ► Chapter 9

For 16.4 ft (5 m) chain, color black, with pivoting mounting brackets
16.4 ft (5 m) 2480-10-100-0 and 2100-34PZ+

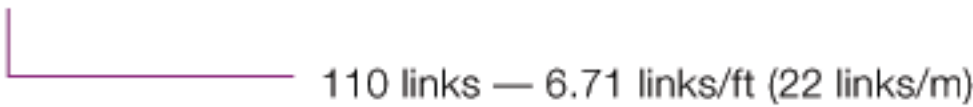

Technical data

Chain Type	Weight Per Link		Weight	
	(oz.)	(g)	(lbs/ft)	(kg/m)
2480-03	0.081	(0.037)	0.54	(0.81)
2480-05	0.090	(0.041)	0.60	(0.90)
2480-07	0.101	(0.046)	0.68	(1.01)
2480-10	0.128	(0.058)	0.77	(1.15)

Material	igumid G
Permitted temperature	-40°/+266°F (-40°/+130°C)
Gliding speed max.	16.4 ft/s (5 m/s)
Unsupported V max.	32.8 ft/s (10 m/s)
Flammability class	VDE 0304 IIC UL94 1H



upon request