



Cable Management Accessories

Grip Ties	110-113
Cable Ties and Tools	114-118
Mounts	119-121
Clips and Clamps	122
PicPac	123
El-Ty Strapping System	124
Aerial Support Spacer Ties	125
Convuluted Tubing	126



Grip Tie Straps

The Grip Tie is a low profile, one piece fastening device. Constructed of polyethylene hook and nylon loop, laminated back to back, the Grip Tie features quick release for repetitive access to cable and wire. It can be opened and closed numerous times without failure. The Grip Tie is reusable, adjustable, releasable and easy to install. Its design provides ease of installation in tight areas such as telecommunications closets and will not get caught on other cables. The tie also will not cause damage to Category 5e and Category 6 cable or fiber optic cable since it cannot be over-cinched.

Available in rolls and straps in 6", 8", 11" and 15" sizes. The Grip Ties are available in a variety of colors and are versatile enough for applications ranging from network installations to bundling power cords. Grip ties are customizable with your company name (minimum quantities apply).

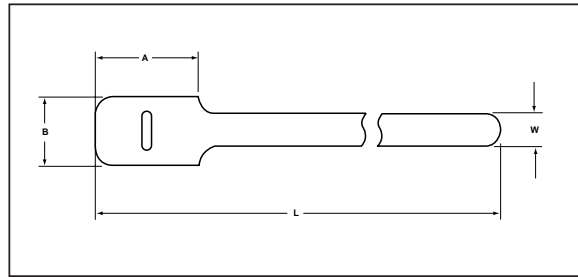

Grip Tie Straps

Product Selection

Part Number	Color	Bundle Diameter	Tensile Strength	Length (L)	Width (W)	Head Length (A)	Head Width (B)	Pkg. Qty.
6" Straps								
GT.375X60C2	Black	1"	40 lbs.	6"	.375"	1.5"	.75"	100
GT.50X60P2	Black	1"	40 lbs.	6"	0.5"	1.5"	1"	10
GT.50X60C2	Black	1"	40 lbs.	6"	0.5"	1.5"	1"	100
GT.50X62P2	Red	1"	40 lbs.	6"	0.5"	1.5"	1"	10
GT.50X62C2	Red	1"	40 lbs.	6"	0.5"	1.5"	1"	100
GT.50X63P2	Orange	1"	40 lbs.	6"	0.5"	1.5"	1"	10
GT.50X63C2	Orange	1"	40 lbs.	6"	0.5"	1.5"	1"	100
GT.50X64P2	Yellow	1"	40 lbs.	6"	0.5"	1.5"	1"	10
GT.50X64C2	Yellow	1"	40 lbs.	6"	0.5"	1.5"	1"	100
GT.50X65P2	Green	1"	40 lbs.	6"	0.5"	1.5"	1"	10
GT.50X65C2	Green	1"	40 lbs.	6"	0.5"	1.5"	1"	100
GT.50X66P2	Blue	1"	40 lbs.	6"	0.5"	1.5"	1"	10
GT.50X66C2	Blue	1"	40 lbs.	6"	0.5"	1.5"	1"	100



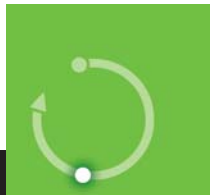

Grip Tie Straps

Product Selection

Part Number	Color	Bundle Diameter	Tensile Strength	Length (L)	Width (W)	Head Length (A)	Head Width (B)	Pkg. Qty.
8" Straps								
GT.50X80P2	Black	1.75"	40 lbs.	8"	0.5"	1.5"	1"	10
GT.50X80C2	Black	1.75"	40 lbs.	8"	0.5"	1.5"	1"	100
GT.50X82P2	Red	1.75"	40 lbs.	8"	0.5"	1.5"	1"	10
GT.50X82C2	Red	1.75"	40 lbs.	8"	0.5"	1.5"	1"	100
GT.50X83P2	Orange	1.75"	40 lbs.	8"	0.5"	1.5"	1"	10
GT.50X83C2	Orange	1.75"	40 lbs.	8"	0.5"	1.5"	1"	100
GT.50X84P2	Yellow	1.75"	40 lbs.	8"	0.5"	1.5"	1"	10
GT.50X84C2	Yellow	1.75"	40 lbs.	8"	0.5"	1.5"	1"	100
GT.50X85P2	Green	1.75"	40 lbs.	8"	0.5"	1.5"	1"	10
GT.50X85C2	Green	1.75"	40 lbs.	8"	0.5"	1.5"	1"	100
GT.50X86P2	Blue	1.75"	40 lbs.	8"	0.5"	1.5"	1"	10
GT.50X86C2	Blue	1.75"	40 lbs.	8"	0.5"	1.5"	1"	100
11" Straps								
GT.50X110P2	Black	2.63"	40 lbs.	11"	0.5"	1.5"	1"	10
GT.50X110C2	Black	2.63"	40 lbs.	11"	0.5"	1.5"	1"	100
GT.50X112P2	Red	2.63"	40 lbs.	11"	0.5"	1.5"	1"	10
GT.50X112C2	Red	2.63"	40 lbs.	11"	0.5"	1.5"	1"	100
GT.50X113P2	Orange	2.63"	40 lbs.	11"	0.5"	1.5"	1"	10
GT.50X113C2	Orange	2.63"	40 lbs.	11"	0.5"	1.5"	1"	100
GT.50X114P2	Yellow	2.63"	40 lbs.	11"	0.5"	1.5"	1"	10
GT.50X114C2	Yellow	2.63"	40 lbs.	11"	0.5"	1.5"	1"	100
GT.50X115P2	Green	2.63"	40 lbs.	11"	0.5"	1.5"	1"	10
GT.50X115C2	Green	2.63"	40 lbs.	11"	0.5"	1.5"	1"	100
GT.50X116P2	Blue	2.63"	40 lbs.	11"	0.5"	1.5"	1"	10
GT.50X116C2	Blue	2.63"	40 lbs.	11"	0.5"	1.5"	1"	100
15" Straps								
GT.75X150P2	Black	3.88"	50 lbs.	15"	0.75"	2.5"	1.5"	10
GT.75X150C2	Black	3.88"	50 lbs.	15"	0.75"	2.5"	1.5"	100
GT.75X152P2	Red	3.88"	50 lbs.	15"	0.75"	2.5"	1.5"	10
GT.75X152C2	Red	3.88"	50 lbs.	15"	0.75"	2.5"	1.5"	100
GT.75X153P2	Orange	3.88"	50 lbs.	15"	0.75"	2.5"	1.5"	10
GT.75X153C2	Orange	3.88"	50 lbs.	15"	0.75"	2.5"	1.5"	100
GT.75X154P2	Yellow	3.88"	50 lbs.	15"	0.75"	2.5"	1.5"	10
GT.75X154C2	Yellow	3.88"	50 lbs.	15"	0.75"	2.5"	1.5"	100
GT.75X155P2	Green	3.88"	50 lbs.	15"	0.75"	2.5"	1.5"	10
GT.75X155C2	Green	3.88"	50 lbs.	15"	0.75"	2.5"	1.5"	100
GT.75X156P2	Blue	3.88"	50 lbs.	15"	0.75"	2.5"	1.5"	10
GT.75X156C2	Blue	3.88"	50 lbs.	15"	0.75"	2.5"	1.5"	100

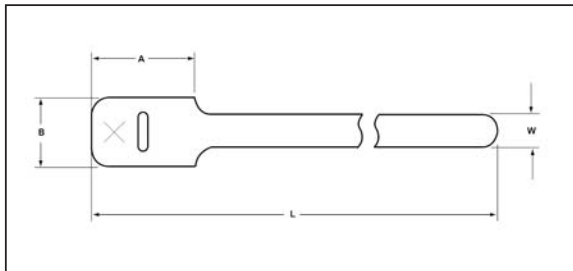

Drawing reflects the 8" size Grip Tie. The head contains an "x" cut out for screw applications.

Grip Tie Assortment Pack

For a variety of grip ties, an assortment pack containing the four different sizes and six different colors is available.

Product Selection

Part Number	Contents
GTASST	One (1) Orange 6" Grip Tie (GT.50X63) One (1) Yellow 6" Grip Tie (GT.50X64) One (1) Blue 8" Grip Tie (GT.50X86) One (1) Black 8" Grip Tie (GT.50X80) One (1) Green 11" Grip Tie (GT.50X115) One (1) Red 15" Grip Tie (GT.75X152)



Grip Tie Rolls

For custom-cut lengths, HellermannTyton offers the hook and loop strap on a five yard and 25 yard roll. Ideal for job site applications, desired lengths can be cut on the spot.

Product Selection

Part Number	Color	Length	Width	Pkg. Qty.
GT.75X1800	Black	180" (5 yds.)	0.75"	1 roll
GT.75X1802	Red	180" (5 yds.)	0.75"	1 roll
GT.75X1803	Orange	180" (5 yds.)	0.75"	1 roll
GT.75X1804	Yellow	180" (5 yds.)	0.75"	1 roll
GT.75X1805	Green	180" (5 yds.)	0.75"	1 roll
GT.75X1806	Blue	180" (5 yds.)	0.75"	1 roll
GT.75X6000	Black	600" (16.6 yds.)	0.75"	1 roll
GT.75X9000	Black	900" (25 yds.)	0.75"	1 roll
GT.75X9004	Yellow	900" (25 yds.)	0.75"	1 roll



Write-on Grip Ties

In situations where instant identification is needed, HellermannTyton provides Grip Ties with a white write-on area. This smudge-free surface is ideal for fast and easy identification with a ballpoint pen or felt-tip marker. The write-on area is approximately 3/8"(H) x 1-1/4"(W). It is positioned in the center of the black 6", 8" and 11" straps, as well as spaced every 12" on the Grip Tie rolls.

Product Selection

Part Number	Description	Strap Length	Strap Width	Pkg. Qty.
GT.50X60P2W	Black Grip Tie with White Write-On Area	6"	0.5"	10
GT.50X60C2W	Black Grip Tie with White Write-On Area	6"	0.5"	100
GT.50X80P2W	Black Grip Tie with White Write-On Area	8"	0.5"	10
GT.50X80C2W	Black Grip Tie with White Write-On Area	8"	0.5"	100
GT.50X110P2W	Black Grip Tie with White Write-On Area	11"	0.5"	10
GT.50X110C2W	Black Grip Tie with White Write-On Area	11"	0.5"	100
GT.75X1800W	Black Grip Tie Roll with White Write-On Area	180"	0.75"	1 Roll



Grip Ties For Plenum Applications

HellermannTyton now introduces UL94V-2 flame rated Grip Ties for use in air handling spaces. These Grip Ties are UL Listed in accordance with the National Electrical Code regulations. They are available in three lengths as well as a 180" roll.

Product Selection

Part Number	Color	Bundle Diameter	Tensile Strength	Length	Width	Pkg Qty.
GT.50X6MP2V2	Maroon	1"	40 lbs.	6"	0.5"	10
GT.50X8MP2V2	Maroon	1.91"	40 lbs.	8"	0.5"	10
GT.50X12MP2V2	Maroon	3.18"	40 lbs.	12"	0.5"	10
GT.75X180MV2	Maroon	1 - 5"	50 lbs.	180"	0.75"	1



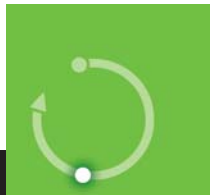

Low Profile Grip Ties

HellermannTyton offers a new, lower profile self gripping hook and loop strap. Similar to the standard Grip Ties, they are easily wrapped around a bundle and fastened onto themselves for a secure hold. The head size is twice as wide as the strap, providing added strength. The modest thickness of the back-to-back hook and loop is ideal for small areas without the worry of snagging. The head contains an "X" cut out for screw mount applications. The low profile design is available in black in various lengths, as well as a 5 yard roll.

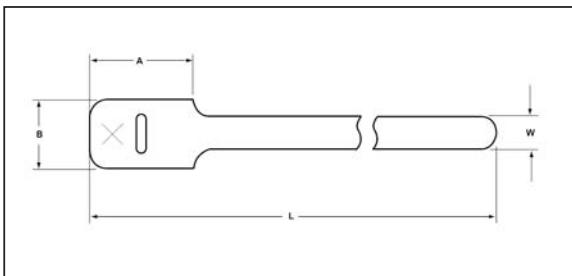
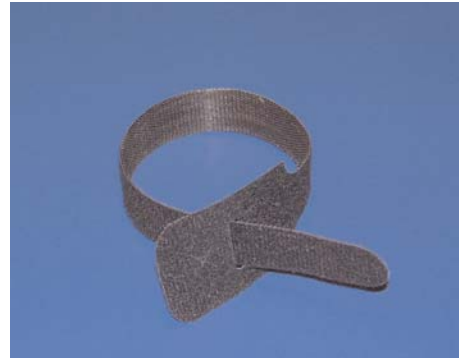

Product Selection

Part No.	Color	Length (L)	Width (W)	Head Length (A)	Head Width (B)	Pkg Qty.
GTLP50X60P2	Black	6"	0.5"	1.5"	1.0"	10
GTLP50X80P2	Black	8"	0.5"	1.5"	1.0"	10
GTLP50X110P2	Black	11"	0.5"	1.5"	1.0"	10
GTLP75X1800	Black	180"	0.75"	N/A	N/A	1 Roll

Grip Tie Mounts

To secure bundles to flat surfaces, HellermannTyton offers a mounting base to be used with the Grip Ties. Available with or without adhesive, two sizes of Grip Tie mounts cover every size of Grip Tie. The mounts are manufactured from nylon 6/6 material and are UV-stabilized for outdoor applications.



Grip Tie Mounts

Product Selection

Part Number	Color	Width x Length	Mount Method	Used With GT	Pkg. Qty.
GTM500C2	Black	1" x 2.5"	1/4" screw	GT.50 X 6, GT.50 X 8, GT.50 X 11	100
GTM50A0C2	Black	1" x 2.5"	Adhesive	GT.50 X 6, GT.50 X 8, GT.50 X 11	100
GTM1000C2	Black	1.5" x 3.25"	1/4" screw	GT.75 X 15, GT Rolls	100
GTM100A0C2	Black	1.5" x 3.25"	Adhesive	GT.75 X 15, GT Rolls	100



Cable Management Accessories

HellermannTyton manufactures a full line of quality cable ties in a wide variety of materials, colors, styles and sizes. Used to bundle and secure wire and cable, these cable ties are engineered and manufactured for maximum performance and quality.

HellermannTyton offers many options of cable ties. Whether the application demands extra strength, mounting, releasable, identification features or more, HellermannTyton has the cable tie to fit the requirement.



Standard Cable Ties

Standard cable ties include varying strengths and lengths for each individual application.



U.S. Patent Numbers 3,127,648 – 3,486,201

Product Selection

Part Number	Color	Government Designation	Min. Tensile Unlocking Strength	Max. Bundle Diameter In. (mm)	Approx. Length In. (mm)	Approx. Width In. (mm)	Pkg. Qty.	Installation Tools
T18S9C2*	Natural	MS3367-4	18 lbs.	5/8"	3-3/8"	.08"	100	TWT1, MK7, MK7P
T18S0C2*	Black			(15.9)	(85.7)	(2.0)	100	MK3P
T18S9M4*	Natural	MS3367-4	18 lbs.	5/8"	3-3/8"	.08"	1000	TWT1, MK7, MK7P
T18S0M4*	Black			(15.9)	(85.7)	(2.0)	1000	MK3P
T18R9C2*	Natural	MS3367-4	18 lbs.	3/4"	4"	.10"	100	TWT1, MK7, MK7P,
T18R0C2*	Black			(19.0)	(101.6)	(2.5)	100	MK9, MK3P
T18R9M4*	Natural	MS3367-4	18 lbs.	3/4"	4"	.10"	1000	TWT1, MK7, MK7P,
T18R0M4*	Black			(19.0)	(101.6)	(2.5)	1000	MK9, MK3P
T18I9C2***	Natural	MS3367-4	18 lbs.	1-1/4"	5-2/3"	.10"	100	TWT1, MK7, MK7P,
T18I0C2***	Black			(31.8)	(143.9)	(2.5)	100	MK9, MK3P
T18I9M4***	Natural	MS3367-4	18 lbs.	1-1/4"	5-2/3"	.10"	1000	TWT1, MK7, MK7P,
T18I0M4***	Black			(31.8)	(143.9)	(2.5)	1000	MK9, MK3P
T18L9C2***	Natural	MS3367-4	18 lbs.	2"	8"	.10"	100	TWT1, MK7, MK7P,
T18L0C2***	Black			(50.8)	(203.2)	(2.5)	100	MK9, MK3P
T18L9M4***	Natural	MS3367-4	18 lbs.	2"	8"	.10"	1000	TWT1, MK7, MK7P,
T18L0M4***	Black			(50.8)	(203.2)	(2.5)	1000	MK9, MK3P
T30R9C2*	Natural	MS3367-5	30 lbs.	1-1/4"	6"	.14"	100	TWT1, MK7, MK7P,
T30R0C2*	Black			(31.8)	(152.4)	(3.6)	100	MK9, MK3P
T30R9M4*	Natural	MS3367-5	30 lbs.	1-1/4"	6"	.14"	1000	TWT1, MK7, MK7P,
T30R0M4*	Black			(31.8)	(152.4)	(3.6)	1000	MK9, MK3P
T30M9C2	Natural		30 lbs.	2"	8"	.14"	100	TWT1, MK7, MK7P,
T30M0C2	Black			(50.8)	(203.2)	(3.6)	100	MK9, MK3P
T30M9M4	Natural		30 lbs.	2"	8"	.14"	1000	TWT1, MK7, MK7P,
T30M0M4	Black			(50.8)	(203.2)	(3.6)	1000	MK9, MK3P
T30I9C2	Natural		30 lbs.	3"	11-3/4"	.14"	100	TWT1, MK7, MK7P,
T30I0C2	Black			(76.2)	(298.5)	(3.8)	100	MK9, MK3P
T30I9M4	Natural		30 lbs.	3"	11-3/4"	.14"	1000	TWT1, MK7, MK7P,
T30I0M4	Black			(76.2)	(298.5)	(3.8)	1000	MK9, MK3P
T30L9C2	Natural		30 lbs.	4"	14-1/4"	.15"	100	TWT1, MK7, MK7P,
T30L0C2	Black			(101.6)	(362)	(3.8)	100	MK9, MK3P
T30L9M4	Natural		30 lbs.	4"	14-1/4"	.15"	1000	TWT1, MK7, MK7P,
T30L0M4	Black			(101.6)	(362)	(3.8)	1000	MK9, MK3P
T40R9C2*	Natural		40 lbs.	2"	8-1/2"	.15"	100	TWT1, MK7, MK7P,
T40R0C2*	Black			(50.8)	(215.9)	(3.8)	100	MK9, MK3P
T40R9M4*	Natural		40 lbs.	2"	8-1/2"	.15"	1000	TWT1, MK7, MK7P,
T40R0M4*	Black			(50.8)	(215.9)	(3.8)	1000	MK9, MK3P
T40I9C2*	Natural		40 lbs.	3"	11-1/2"	.15"	100	TWT1, MK7, MK7P,
T40I0C2*	Black			(76.2)	(292.1)	(3.8)	100	MK9, MK3P
T40I9M4*	Natural		40 lbs.	3"	11-1/2"	.15"	1000	TWT1, MK7, MK7P,
T40I0M4*	Black			(76.2)	(292.1)	(3.8)	1000	MK9, MK3P



Note: *AS23190E (formerly Mil-S-23190E) (Type I Class 1). ***HellermannTyton QPL23190 Listed as exceeding the tensile strength of length and meeting MS3367 (Type I Class 1). Contact HellermannTyton for other colors. Note: The official reference to the military specification is now SAE-AS23190 and SAE-AS3367.

Cable Management Accessories

Standard Cable Ties *continued*

U.S. Patent Numbers 3,127,648 – 3,486,201



Product Selection

Part Number	Color	Government Designation	Min. Tensile Unlocking Strength	Max. Bundle Diameter In. (mm)	Approx. Length In. (mm)	Approx. Width In. (mm)	Pkg. Qty.	HellermannTyton Installation Tools
T40L9C2*	Natural		40 lbs.	4"	14-1/2"	.15"	100	TWT1, MK7, MK7P,
T40L0C2*	Black			(101.6)	(368.3)	(3.8)	100	MK9, MK3P
T40L9M4*	Natural		40 lbs.	4"	14-1/2"	.15"	1000	TWT1, MK7, MK7P,
T40L0M4*	Black			(101.6)	(368.3)	(3.8)	1000	MK9, MK3P
T50S9C2	Natural		50 lbs.	1-1/4"	6-1/2"	.18"	100	TWT1, MK7, MK7P,
T50S0C2	Black			(31.8)	(165.1)	(4.6)	100	MK9, MK3P
T50S9M4	Natural		50 lbs.	1-1/4"	6-1/2"	.18"	1000	TWT1, MK7, MK7P,
T50S0M4	Black			(31.8)	(165.1)	(4.6)	1000	MK9, MK3P
T50R9C2*	Natural	MS3367-1	50 lbs.	1-3/4"	8"	.18"	100	TWT1, MK7, MK7P,
T50R0C2*	Black			(44.5)	(203.2)	(4.6)	100	MK9, MK3P
T50R9M4*	Natural	MS3367-1	50 lbs.	1-3/4"	8"	.18"	1000	TWT1, MK7, MK7P,
T50R0M4*	Black			(44.5)	(203.2)	(4.6)	1000	MK9, MK3P
T50I9C2*	Natural	MS3367-7	50 lbs.	3"	11-3/4"	.18"	100	TWT1, MK7, MK7P,
T50I0C2*	Black			(76.2)	(298.5)	(4.6)	100	MK9, MK3P
T50I9M4*	Natural	MS3367-7	50 lbs.	3"	11-3/4"	.18"	1000	TWT1, MK7, MK7P,
T50I0M4*	Black			(76.2)	(298.5)	(4.6)	1000	MK9, MK3P
T50L9C2*	Natural	MS3367-2	50 lbs.	4"	15-1/2"	.18"	100	TWT1, MK7, MK7P,
T50L0C2*	Black			(101.6)	(393.7)	(4.6)	100	MK9, MK3P
T50L9M4*	Natural	MS3367-2	50 lbs.	4"	15-1/2"	.18"	1000	TWT1, MK7, MK7P,
T50L0M4*	Black			(101.6)	(393.7)	(4.6)	1000	MK9, MK3P



Note: *AS23190E (formerly Mil-S-23190E) (Type I Class I). Contact HellermannTyton for other colors.
 ØUV color is a 2% carbon tie which meets the MIL spec. and also gives a cable tie better weatherability against UV rays.
 Note: The official reference to the military specification is now SAE-AS23190 and SAE-AS3367.

Releasable Cable Ties

In applications that require frequent cable moves, HellermannTyton's releasable cable ties provide easy removal as well as reusability.



RT Ties



REL Ties

Product Selection

Part Number	Color	Min. Tensile Unlocking Strength	Max. Bundle Diameter In. (mm)	Approx. Length In. (mm)	Approx. Width In. (mm)	Pkg. Qty.
RT40R9C2	Natural	40 lbs.	2"	8-1/2"	.16"	100
RT40R0C2	Black		(50.8)	(215.9)	(4.1)	100
RT40R9M4	Natural	40 lbs.	2"	8-1/2"	.16"	1000
RT40R0M4	Black		(50.8)	(215.9)	(4.1)	1000
RT50S9C2	Natural	50 lbs.	1-3/8"	6-1/2"	.18"	100
RT50S0C2	Black		(34.9)	(165.1)	(4.6)	100
RT50S9M4	Natural	50 lbs.	1-3/8"	6-1/2"	.18"	1000
RT50S0M4	Black		(34.9)	(165.1)	(4.6)	1000
RT50LL9C2	Natural	50 lbs.	4"	15-1/2"	.18"	100
RT50LL0C2	Black		(101.60)	(393.7)	(4.6)	100
RT50LL9M4	Natural	50 lbs.	4"	15-1/2"	.18"	1000
RT50LL0M4	Black		(101.60)	(393.7)	(4.6)	1000
REL50R9C2	Natural	50 lbs.	1-3/8"	5-1/2"	.29"	100
REL50R0C2	Black		(34.9)	(139.7)	(7.39)	100
REL50R9L4	Natural	50 lbs.	1-3/8"	5-1/2"	.29"	200
REL50R0L4	Black		(34.9)	(139.7)	(7.39)	200
REL50L9C2	Natural	50 lbs.	2-3/4"	10"	.29"	100
REL50L0C2	Black		(69.8)	(254.0)	(7.39)	100
REL50L9L4	Natural	50 lbs.	2-3/4"	10"	.29"	200
REL50L0L4	Black		(69.8)	(254.0)	(7.39)	200



Contact HellermannTyton for other colors.



Mounting Cable Ties

The mounting cable ties are a one piece, all plastic tie for quick, simple cable mounting. Designed to fit several screw sizes and hole diameters, the mounting tie can be attached to equipment, walls, ceilings or other surfaces.



Product Selection

Part Number	Color	Mounting	Min. Tensile Unlocking	Max. Bundle Diameter Strength	Approx. Length In. (mm)	Approx. Width In. (mm)	Pkg. Qty. In. (mm)	HellermannTyton Installation Tools
T18MR9C2	Natural	#4 Screw	18 lbs.	3/4"	4-1/4"	.10"	100	TWT1, MK7, MK7P,
T18MR0C2	Black			(19.0)	(107.9)	(2.5)	100	MK9, MK3P
T18MR9M4	Natural	#4 Screw	18 lbs.	3/4"	4-1/4"	.10"	1000	TWT1, MK7, MK7P,
T18MR0M4	Black			(19.0)	(107.9)	(2.5)	1000	MK9, MK3P
T30MR9C2	Natural	#8 Screw	30 lbs.	1-1/4"	6-1/4"	.14"	100	TWT1, MK7, MK7P,
T30MR0C2	Black			(31.7)	(158.7)	(3.6)	100	MK9, MK3P
T30MR9M4	Natural	#8 Screw	30 lbs.	1-1/4"	6-1/4"	.14"	1000	TWT1, MK7, MK7P,
T30MR0M4	Black			(31.7)	(158.7)	(3.6)	1000	MK9, MK3P
T50MR9C2	Natural	#10 Screw	50 lbs.	1-3/4"	8-1/2"	.18"	100	TWT1, MK7, MK7P, MK9,
T50MR0C2	Black			(44.4)	(215.9)	(4.6)	100	MK3P, MK6PN
T50MR9M4	Natural	#10 Screw	50 lbs.	1-3/4"	8-1/2"	.18"	1000	TWT1, MK7, MK7P, MK9,
T50MR0M4	Black			(44.4)	(215.9)	(4.6)	1000	MK3P, MK6PN
T50MRT9C2	Natural	#6-32	50 lbs.	1-3/4"	8-1/2"	.18"	100	TWT1, MK7, MK7P, MK9,
T50MRT0C2	Black	Tap thru Screw		(44.4)	(215.9)	(4.6)	100	MK3P, MK6PN
T50MRT9M4	Natural	#6-32	50 lbs.	1-3/4"	8-1/2"	.18"	1000	TWT1, MK7, MK7P, MK9,
T50MRT0M4	Black	Tap thru Screw		(44.4)	(215.9)	(4.6)	1000	MK3P, MK6PN
T50MI9C2	Natural	#10 Screw	50 lbs.	3"	11-3/4"	.18"	100	TWT1, MK7, MK7P, MK9,
T50MI0C2	Black			(76.2)	(298.45)	(4.57)	1000	MK3P, MK6PN
T50MI9M4	Natural	#10 Screw	50 lbs.	3"	11-3/4"	.18"	100	TWT1, MK7, MK7P, MK9,
T50MI0M4	Black			(76.2)	(298.45)	(4.57)	1000	MK3P, MK6PN
T50ML9C2	Natural	#10 Screw	50 lbs.	4"	16"	.18"	100	TWT1, MK7, MK9, MK3P,
T50ML0C2	Black			(101.6)	(406.4)	(4.6)	100	MK6PN
T50ML9M4	Natural	#10 Screw	50 lbs.	4"	16"	.18"	1000	TWT1, MK7, MK9, MK3P,
T50ML0M4	Black			(101.6)	(406.4)	(4.6)	1000	MK6PN
T120MR9K2	Natural	1/4" Screw	120 lbs.	4"	16-1/4"	.30"	50	TWT2, MK9, MK6PN
T120MR0K2	Black			(101.6)	(412.7)	(7.6)	50	
T120MR9H4	Natural	1/4" Screw	120 lbs.	4"	16-1/4"	.30"	500	TWT2, MK9, MK6PN
T120MR0H4	Black			(101.6)	(412.7)	(7.6)	500	



U.S. Patent Numbers
3,127,648 - 3,486,201

Contact HellermannTyton for other colors.

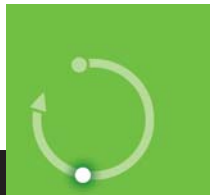

Cable Ties for Plenum Applications

HellermannTyton halar and U.L. Listed cable ties meet NEC regulations and can be used in applications where low smoke and low flame are a concern in air handling spaces. The raw material used to manufacture HellermannTyton halar cable ties is UL 94V-0 rated.

The halar ties come in a distinct color of red for easy identification. The U.L. ties are available in natural or red.



Product Selection

Part Number	Color	Min. Tensile Unlocking Strength	Max. Bundle Diameter In. (mm)	Approx. Length In. (mm)	Approx. Width In. (mm)	Pkg. Qty.	HellermannTyton Installation Tools
T18R2HALC2	Red	18 lbs.	7/8"	4"	.10"	100	TWT1, MK7, MK7P, MK9, MK3P
T18R2HALM4			(22.2)	(101.6)	(2.5)	1000	
T30M2HALC2	Red	30 lbs.	2"	8"	.14"	100	TWT1, MK7, MK7P, MK9, MK3P
T30M2HALM4			(50.8)	(203.2)	(3.6)	1000	
T50R2HALC2	Red	50 lbs.	1-3/4"	8"	.18"	100	TWT1, MK7, MK7P, MK9, MK3P, MK6PN
T50R2HALM4			(44.5)	(203.2)	(4.6)	1000	
T120R2HALK2	Red	120 lbs.	4"	15-1/4"	.18"	50	TWT2, MK9, MK6PN
T120R2HALH4			(101.6)	(387.4)	(4.6)	500	
T18R9C2UL	Natural	18 lbs.	3/4"	4"	.10"	100	TWT1, MK7, MK7P, MK9, MK3P
T18R9M4UL			(19.0)	(101.6)	(2.5)	1000	
T18R2C2UL	Red	18 lbs.	3/4"	4"	.10"	100	TWT1, MK7, MK7P, MK9, MK3P
T18R2M4UL			(19.0)	(101.6)	(2.5)	1000	
T50R9C2UL	Natural	50 lbs.	1-3/4"	8"	.18"	100	TWT1, MK7, MK7P, MK9, MK3P, MK6PN
T50R9M4UL			(44.5)	(203.2)	(4.6)	100	
T50R2C2UL	Red	50 lbs.	1-3/4"	8"	.18"	100	TWT1, MK7, MK7P, MK9, MK3P, MK6PN
T50R2M4UL			(44.5)	(203.2)	(4.6)	100	
T50I9C2UL	Natural	50 lbs.	3"	11-3/4"	.18"	100	TWT1, MK7, MK7P, MK9, MK3P, MK6PN
T50I9M4UL			(76.2)	(298.5)	(4.6)	100	
T50I2C2UL	Red	50 lbs.	3"	11-3/4"	.18"	100	TWT1, MK7, MK7P, MK9, MK3P, MK6PN
T50I2M4UL			(76.2)	(298.5)	(4.6)	100	
T50L9C2UL	Natural	50 lbs.	4"	15-1/2"	.18"	100	TWT1, MK7, MK7P, MK9, MK3P, MK6PN
T50L9M4UL			(101.6)	(393.7)	(4.6)	1000	
T50L2C2UL	Red	50 lbs.	4"	15-1/2"	.18"	100	TWT1, MK7, MK7P, MK9, MK3P, MK6P
T50L2M4UL			(101.6)	(393.7)	(4.6)	1000	



Grip Ties For Plenum Applications

HellermannTyton now introduces UL94V-2 flame rated Grip Ties for use in air handling spaces. These Grip Ties are UL Listed in accordance with the National Electrical Code regulations. They are available in three lengths as well as a 180" roll.



Product Selection

Part Number	Color	Bundle Diameter	Tensile strength	Length	Width	Pkg Qty.
GT.50X6MP2V2	Maroon	1"	40 lbs.	6"	0.5"	10
GT.50X8MP2V2	Maroon	1.91"	40 lbs.	8"	0.5"	10
GT.50X12MP2V2	Maroon	3.18"	40 lbs.	12"	0.5"	10
GT.75X180MV2	Maroon	1 - 5"	50 lbs.	180"	0.75"	1





Cable Tie Tensioning Tools

HellermannTyton offers advanced, quality engineered cable tie tools suitable for most any cable tie application. Available in mechanical, power assisted, and automatic versions, HellermannTyton’s tools are industry preferred for their ergonomic designs, reliability, and ease of use.

HellermannTyton’s tools make it easier for the installer to apply cable ties, while maintaining correct tension and flush cut-off. Safety is enhanced, as the tools can eliminate the sharp edges of a cut-off cable tie.

Ranging from pocket sized tools to the state-of-the-art Mark 7 and Mark 9 tools, HellermannTyton offers mechanical tools which can be used with any HellermannTyton cable tie.

Mechanical Tools

Product Selection

Part Number	Description	Cable Tie Series	Pkg. Qty.
TWT1	TytonTwyster: Lightweight and economical twist tool. Offers speed and efficiency. Fits into a pocket. (color: orange)	T18 thru T50 Series	1
TWT2	TytonTwyster: Lightweight and economical twist tool. Offers speed and efficiency. Fits into a pocket. (color: blue)	CTT20 thru CTT60 Series	1
T150	T150 Tool: Heavy-duty installer controlled tool for use in the field. Pliers action provides mechanical advantage. Non-slip grip handles provide comfort & control.	T120 thru T150 Series CTT175 Series	1
T250	Same design features as the T150 tool, but can tension and cut-off a wider tie.	T150 thru T250 Series / CTT175 Series	1
MK7 Mil. Spec. MS90387-1	MK7: Durable and lightweight, this tool is user-friendly and adjustable, with top-of-the-line design features. Comes standard with non-slip grip handles.	T18 thru T50 Series CTT20 thru CTT60 Series	1
MK7HT	MK7HT: With the same design features as the MK7, this tool offers an increased tension range. Also comes standard with non-slip grip handles.	T18 thru T50 Series CTT20 thru CTT60 Series	1
MK9 Mil. Spec. MS90387-2	MK9: The MK9 has the same design features as the MK7 series tools. The MK9 accommodates a wider variety of sizes. Comes standard with non-slip grip handles.	T18R thru T250 Series CTT20 thru CTT175 Series EL-TY Series	1
MK9HT	MK9HT: The MK9HT has the same design features as the MK9, and offers an increased tension range. Also comes standard with non-slip grip handles.	T18R thru T250 Series CTT20 thru CTT175 Series, EL-TY Series	1

Contact HellermannTyton for more information on power assisted and automatic tools.

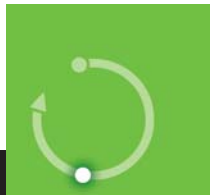

Cable Tie Mounting Base (MB Series)

Used in conjunction with cable ties, HellermannTyton mounting bases stabilize and secure wire and cable to most surfaces. Provided with or without adhesive, the MB series mounts are available in four sizes to accommodate T18 through T150 series cable ties. Insertion of ties can be made from all four sides. The MB series mounts are manufactured from white and black nylon 6/6.

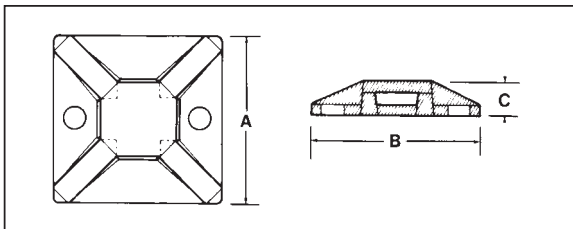
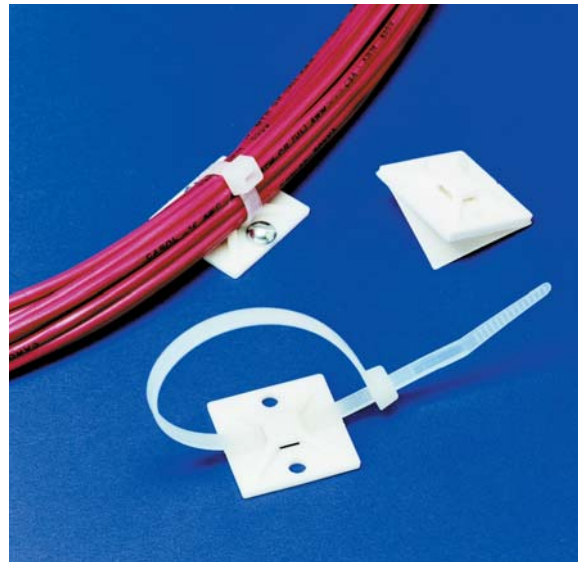

Product Selection

Part Number	Color	Cable Tie Series	Mount Type	Dim. (A)	(B)	(C)	Pkg. Qty.
MB2.50C2	Black	T18	#3 Screw	0.625"	0.625"	0.130"	100
MB2.50M4	Black	T18	#3 Screw	0.625"	0.625"	0.130"	1000
MB2.510C2	White	T18	#3 Screw	0.625"	0.625"	0.130"	100
MB2.510M4	White	T18	#3 Screw	0.625"	0.625"	0.130"	1000
MB2.5A0C2	Black	T18	Adhesive	0.625"	0.625"	0.130"	100
MB2.5A0M4	Black	T18	Adhesive	0.625"	0.625"	0.130"	1000
MB2.5A10C2	White	T18	Adhesive	0.625"	0.625"	0.130"	100
MB2.5A10M4	White	T18	Adhesive	0.625"	0.625"	0.130"	1000
MB30C2	Black	T18, T30	#4 Screw	0.750"	0.750"	0.150"	100
MB30M4	Black	T18, T30	#4 Screw	0.750"	0.750"	0.150"	1000
MB310C2	White	T18, T30	#4 Screw	0.750"	0.750"	0.150"	100
MB310M4	White	T18, T30	#4 Screw	0.750"	0.750"	0.150"	1000
MB3A0C2	Black	T18, T30	Adhesive	0.750"	0.750"	0.150"	100
MB3A0M4	Black	T18, T30	Adhesive	0.750"	0.750"	0.150"	1000
MB3A10C2	White	T18, T30	Adhesive	0.750"	0.750"	0.150"	100
MB3A10M4	White	T18, T30	Adhesive	0.750"	0.750"	0.150"	1000
MB40C2	Black	T18 - T50	#8 Screw	1.125"	1.125"	0.190"	100
MB40H4	Black	T18 - T50	#8 Screw	1.125"	1.125"	0.190"	500
MB410C2	White	T18 - T50	#8 Screw	1.125"	1.125"	0.190"	100
MB410H4	White	T18 - T50	#8 Screw	1.125"	1.125"	0.190"	500
MB4A0H4	Black	T18 - T50	Adhesive	1.125"	1.125"	0.190"	500
MB4A10C2	White	T18 - T50	Adhesive	1.125"	1.125"	0.190"	100
MB4A10H4	White	T18 - T50	Adhesive	1.125"	1.125"	0.190"	500
MB50C2	Black	T18 - T150	#8 Screw	1.500"	1.500"	0.250"	100
MB50F4	Black	T18 - T150	#8 Screw	1.500"	1.500"	0.250"	250
MB510C2	White	T18 - T150	#8 Screw	1.500"	1.500"	0.250"	100
MB510F4	White	T18 - T150	#8 Screw	1.500"	1.500"	0.250"	250
MB5A0C2	Black	T18 - T150	Adhesive	1.500"	1.500"	0.250"	100
MB5A0F4	Black	T18 - T150	Adhesive	1.500"	1.500"	0.250"	250
MB5A10C2	White	T18 - T150	Adhesive	1.500"	1.500"	0.250"	100
MB5A10F4	White	T18 - T150	Adhesive	1.500"	1.500"	0.250"	250





Cable Tie Mount (CTM)

Designed to provide stability to wire bundles, the CTM Series mounts can accommodate miniature, intermediate, or standard cross-section cable ties. Each mount is secured with a single screw.



Product Selection

Part Number	Color	Cable Tie Series	Mount Type	(A)	(B)	(C)	Pkg. Qty.
CTM010C2	White	T18 – T50	#6 Screw	0.380"	0.600"	0.265"	100
CTM010M4	White	T18 – T50	#6 Screw	0.380"	0.600"	0.265"	1000
CTM110C2	White	T18 – T50	#8 Screw	0.380"	0.600"	0.265"	100
CTM110M4	White	T18 – T50	#8 Screw	0.380"	0.600"	0.265"	1000
CTM210C2	White	T18 – T120	#8 Screw	0.620"	0.875"	0.375"	100
CTM210M4	White	T18 – T120	#8 Screw	0.620"	0.875"	0.375"	1000
CTM310C2	White	T18 – T120	#10 Screw	0.620"	0.875"	0.375"	100
CTM310M4	White	T18 – T120	#10 Screw	0.620"	0.875"	0.375"	1000
CTM410C2	White	T18 – T120	.250" Screw	0.620"	0.875"	0.375"	100
CTM410M4	White	T18 – T120	.250" Screw	0.620"	0.875"	0.375"	1000

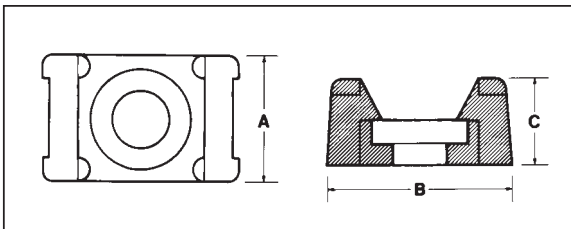

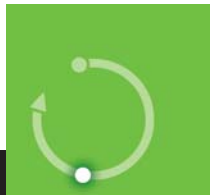

Cable Tie Anchor Mount (CTAM)

The cable tie anchor mount can be placed either parallel or perpendicular to the wire bundle since cable ties may be inserted from any of the four sides of the mount.

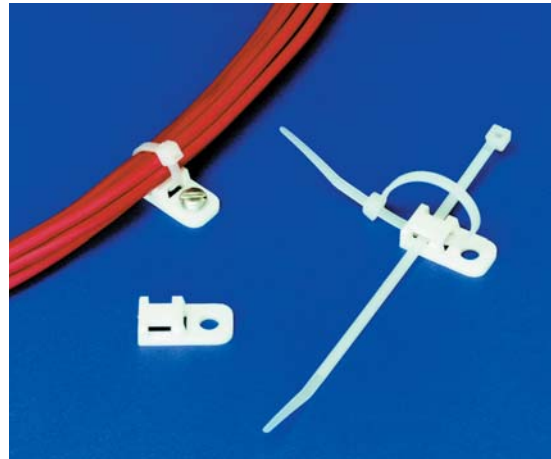
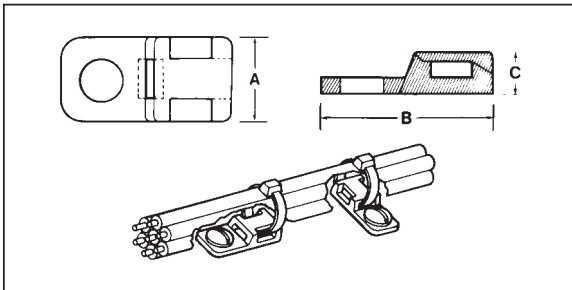

Product Selection

Part Number	Color	Cable Tie Series	Mount Type	(A)	(B)	(C)	Pkg. Qty.
CTAM110C2	White	T18 – T50	#8 Screw	0.400"	0.800"	0.200"	100
CTAM110M4	White	T18 – T50	#8 Screw	0.400"	0.800"	0.200"	1000
CTAM210C2	White	T18 – T50	#10 Screw	0.400"	0.800"	0.200"	100
CTAM210M4	White	T18 – T50	#10 Screw	0.400"	0.800"	0.200"	1000



Cable Tie Anchor Plate (CTAP)

These white cable tie anchor plates have slotted mounting holes to provide for easier alignment of the mount and bundles. Once aligned, they are fastened securely by tightening the applied screw. The CTAP2 allows an additional screw for maximum stability. Both plates are used perpendicular to the wire bundle.

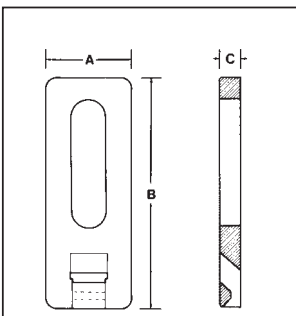

Product Selection

Part Number	Color	Cable Tie Series	Mount Type	(A)	(B)	(C)	Pkg. Qty.
CTAP110C2	White	T18 – T50	#10 Screw	0.500"	1.340"	0.150"	100
CTAP110M4	White	T18 – T50	#10 Screw	0.500"	1.340"	0.150"	1000
CTAP210C2	White	T18 – T50	#10 Screw	0.500"	2.130"	0.140"	100
CTAP210H4	White	T18 – T50	#10 Screw	0.500"	2.130"	0.140"	500





Nail Clips

HellermannTyton nail clips are easy to use and highly reliable. The tough, precision engineered clips hold wire and cable securely in place. The nail is hardened for driving into wood, masonry joints, cinder block and mortar. The nails are also perpendicular to the work surface and are driven in straight, greatly reducing cracking. The nail clips do not have sharp edges, which reduce the chance of cutting cable jackets or sheaths and causing signal loss. Standard material: Tough, engineered plastic. The black clips are UV stabilized. Standard colors: white and black.



Product Selection

Part Number	Nominal Cable Diameter In. (mm)	Nail Length	Color	Pkg. Cable	Qty.
NC3.50	.138"	1.0"	Black	14# Ground Wire	100
NC3.510	(3.5)		White	Telecom 1 pair	
NC50	.197"	1.0"	Black	Telecom 4 pair	100
NC510	(5.0)		White		
NC60	.236"	1.0"	Black	Telecom 6 pair, RG59	100
NC610	(6.0)		White		
NC70	.276"	1.0"	Black	RG6 and RG59 Double Shielded	100
NC710	(7.0)		White		
NC80	.315"	1.0"	Black	Telecom 10 pair RG7, and RG6	100
NC810	(8.0)		White	Double and Quad Shielded	
NC90	.354"	1.0"	Black	Telecom 12 pair	100
NC910	(9.0)		White		
NC110	.433"	1.0"	Black	Telecom 25 pair	100
NC1110	(11.0)		White		
FC140	.287" - .543"	1.0"	Black	RG59 and RG6 Flat Twin and Ground	100
FC1410	(7.3 - 13.8)		White		

Masonry Clips

Masonry clips are a low cost, easy method for mounting station wire and PBX cable to cinder block, masonry, and other forms of concrete. Two steel pins are molded into them, except for M63-3, which is specially designed with only one pin for routing near corners. Standard material: High impact, flame retardant Lexan. Standard color: clear.



Product Selection

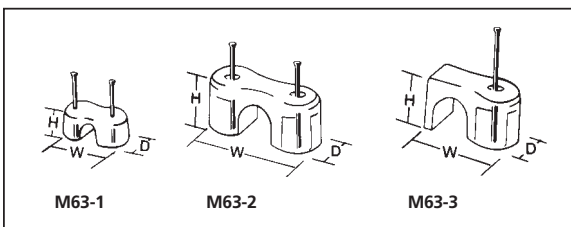

Part Number	Dimensions – In. (mm)			Max. Cable Diameter	Pkg. Qty.
	H	W	D		
M63-1C2	.250" (6.35)	.625" (15.88)	.250" (6.35)	.188" (4.75)	100
M63-2C2	.500" (12.70)	1.25" (31.75)	.500" (12.70)	.500" (12.70)	100
M63-3C2	.500" (12.70)	.875" (22.20)	.500" (12.70)	.500" (12.70)	100

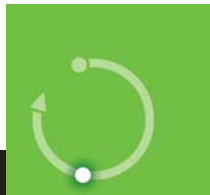

PicPac

The PicPac offers an easy method of identifying binder system groups in PIC cable through the use of Hellermann-Tyton striped and solid cable ties. Each PicPac contains 1,300 ties, including 50 each of the 24 most popular color combinations of striped ties, as well as solid red and solid black ties. All 26 different ties are packaged in easy open bags of 50.

PicPac cases are made from a heavy duty laminated vinyl which is suited to cold weather environments, resistant to cable gel, and can be cleaned inside and out. The reinforced pockets are interlined with foam cushion to ensure that ties remain tightly packed, even when only a few ties are left. Two convenient snaps allow the PicPac to be easily hung or folded.



PocketPac

Designed to fit in a shirt pocket, the PocketPac contains 50 of the most commonly used striped cable ties. The Pocket-Pac case is made of clear vinyl with a snap-lock top for easy access and identification.

Product Selection

Part Number	Description	Pkg. Qty.
T18RPICPAC	Vinyl case containing 1,300 ties including 50 each of the 24 most popular color combinations of striped ties as well as solid black and solid red ties.	1
T18RPOCKETPAC	Case containing 50 of the most commonly used striped ties (10 each of blue, orange, green, brown, and slate, all with white stripes).	1



U.S. Patent Numbers 4,993,669 and 5,102,075

EL-TY Strapping System

HellermannTyton's EL-Ty is a high strength strapping system used for supporting, securing, fastening, and spacing cable, as well as a variety of other applications requiring extra-long, extremely durable strapping.

The EL-Ty consists of a smooth strap and a separate, compact plastic head which encloses a stainless steel gripper. The stackable spacer works with the EL-Ty for a versatile, easy-to-install spacing system.

The EL-Ty has a minimum loop tensile strength of 250 pounds. The continuous operating temperature range is from -40°F to 185°F.

The EL-Ty complies with Bellcore Specification Reference TR-TSY-000789.

Materials: The EL-Ty strap and head are manufactured from black, acetal homopolymer with excellent dielectric properties, UV and chemical resistance, with a UL94-HB flame rating. It has been tested for excellent weatherability against moisture, sunlight and other environmental conditions.

Strap

The strap's smooth edges combined with its excellent UV, chemical, and moisture resistance make the EL-Ty a safe, strong, and labor-saving method of strapping and spacing.

Metal Pawl

The corrosion resistant, stainless steel pawl is contained within the head. The pawl grips the strap in an area protected from damaging sunlight, resulting in long lasting, secure installations.

Head

The black, plastic head is injection molded with serrations on the outside for good gripping and ease of installation. This unique, serrated design helps prevent slippage and allows for easier pull through of the strap during installation. The head is contoured for uniform load distribution on the contact surface.

Spacer

HellermannTyton spacers for the EL-Ty easily press together and are stackable for most any desired spacing applications. Designed for versatility, the strap can be inserted from all four sides, accommodating multiple bundle diameters. Material: UV stabilized, black polypropylene with excellent weatherability and UV resistance.

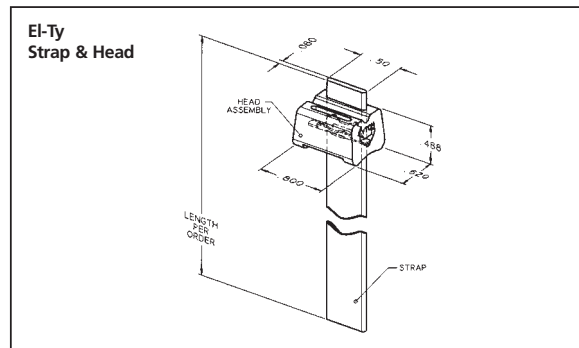

Product Selection

Part Number	Description	Pkg. Qty.
TELS-1	50 ft. of strap on reel dispenser and 30 heads.	1 Kit
TELS-H	Double entry, double locking heads.	25 Heads
TELS-13	10-13.5 in. of cable strap with 10 double locking heads.	10 Straps/Heads
TELS-27	10-27 in. of cable strap with 10 double locking heads.	10 Straps/Heads
TELS-5K	Kit containing 5 reels and 150 heads. Each reel dispenser contains 50 ft.	1 Kit
TELS-10K	Kit containing 10 reels and 300 heads. Each reel dispenser contains 50 ft.	1 Kit
TELS-SPK	Spacer designed for use with the EL-TY.	50
TELS-SPOOL	50 ft. reel	1 Reel



Aerial Support Spacer Tie

Aerial support spacer ties are one piece ties designed for standard spacing applications. These ties are pre-grouped in handy multiples of 5 to save installation time.

Materials: The strap is molded from special high impact nylon 6/6. The spacers are made from a high density outdoor black polypropylene. Both materials in this one piece tie offer resistance to sunlight, saltwater, and harsh chemical environments.



Product Selection

Part Number	Min. Tensile Unlocking Strength	Approx. Length	Approx. Width	Approx. Max. Diameter	Pkg. Qty.
TAS100RWS	100 lbs.	7.50"	.50"	1.75"	100
TAS100MWS	100 lbs.	10.00"	.50"	2.75"	100
TAS100LWS	100 lbs.	16.00"	.50"	4.50"	100

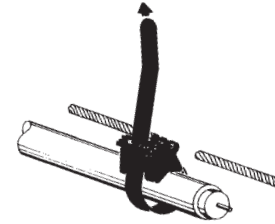

Place the spacer between the cable and strand. Wrap the tie strap around the cable and through the backside loop.

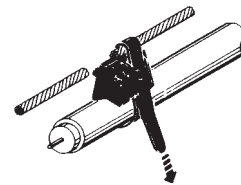

Pull the spacer snug to the cable and wrap the tie strap around the strand. Pass the tie strap through the locking buckle.

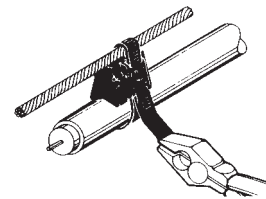

Electrician pliers may be used to snug the installation and snip tail.*

** As the cable and strand expand at different rates, the installation should not be tight but just snug.*

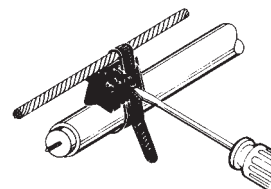

HellermannTyton aerial support spacer ties may be released by inserting a screwdriver under the locking ratchet of the buckle.



Convuluted Tubing

Convuluted tubing provides an efficient method of routing and protecting wire and cable, while reducing the chance of installation damage.

HellermannTyton's convuluted tubing offers excellent protection against vibration wear, water, snow, ice, and the effects of heat, cold, and sunlight on cables and wires.

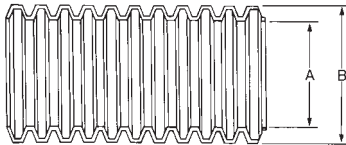

Product Dimensions

Size	I.D. – In. A	O.D. – In. B	Wall Thickness Min.
1/4"	.236"/.264"	.376"/.400"	.004"
3/8"	.344"/.374"	.489"/.519"	.006"
1/2"	.479"/.509"	.660"/.690"	.007"
5/8"	.603"/.633"	.805"/.840"	.007"
3/4"	.720"/.755"	.953"/.988"	.007"
1"	1.008"/1.048"	1.288"/1.328"	.009"
1-1/4"	1.245"/1.295"	1.414"/1.465"	.009"
1-1/2"	1.555"/1.605"	1.853"/1.903"	.009"
2"	1.980"/2.035"	2.343"/2.409"	.009"

Materials

Material	Color	Operating Range
Polyethylene	Black	-40°F - 200°F
Nylon	Black w/ gray stripe	-40°F - 300°F
Flame Retardant Polyethylene*	Gray	-40°F - 200°F
Flame Retardant Polypropylene*	Blue/green Black w/ gray stripe	-40°F - 275°F
Heat Stabilized Polypropylene*	Black w/ green stripe	-40°F - 275°F

* Available upon request. Custom terms apply.

Product Selection

Part Number	Description	Pkg. Qty.
Polyethylene		
CTP140STD	1/4" Black Polyethylene – Standard Carton	3200'
CTP380STD	3/8" Black Polyethylene – Standard Carton	1900'
CTP120STD	1/2" Black Polyethylene – Standard Carton	1100'
CTP580STD	5/8" Black Polyethylene – Standard Carton	800'
CTP340STD	3/4" Black Polyethylene – Standard Carton	550'
CTP105STD	1" Black Polyethylene – Standard Carton	300'
CTP1140STD	1-1/4" Black Polyethylene – Standard Carton	250'
CTP1120STD	1-1/2" Black Polyethylene – Standard Carton	150'
CTP20STD	2" Black Polyethylene – Standard Carton	100'
Nylon		
CTN140STD	1/4" Black Nylon – w/ Gray Stripe – Standard Carton	3200'
CTN380STD	3/8" Black Nylon – w/ Gray Stripe – Standard Carton	1900'
CTN120STD	1/2" Black Nylon – w/ Gray Stripe – Standard Carton	1100'
CTN580STD	5/8" Black Nylon – w/ Gray Stripe – Standard Carton	800'
CTN340STD	3/4" Black Nylon – w/ Gray Stripe – Standard Carton	550'
CTN105STD	1" Black Nylon – w/ Gray Stripe – Standard Carton	300'
CTN1140STD	1-1/4" Black Nylon – w/ Gray Stripe – Standard Carton	250'
CTN1120STD	1-1/2" Black Nylon – w/ Gray Stripe – Standard Carton	150'
CTN20STD	2" Black Nylon – w/ Gray Stripe – Standard Carton	100'

Standard tubing is slit. Unslit is available upon request.
 Please contact HellermannTyton for bulk quantities and pricing
 Colors are available dependent upon volume requirements.
 Please contact HellermannTyton for pre-cut length requirements.