

## RO175

.75" X .75" X 3.0" White Self-Laminating Vinyl, Rite-On Marker, 90/RL

Article Number: 590-01750

Part Number: RO175

Type: RO175

Material: 100



### 1. Base Data

---

**Part No.** RO175

**Type** RO175

**Color** White

**Features** HellermannTyton's Rite-On Markers are made from a flexible vinyl film and used to mark wire and cable. The self-laminating labels have a clear tail which seals the legend under clear vinyl, maintaining the quality of the labels. The Rite-On markers are

**Application** **Product Applications** - Telecom Installations - Residential Applications - Electrical Wiring

**Colour Marking Field** White

## 2. Product Dimensions

---

**Length (L)** .750 " / 19.05

**Width (W)** .750 " / 19.05

**Height (H)** .750 " / 19.05 mm

**Height (H2)** 3.000 " / 76.20 mm

**Min. Ø Bundle** .330 " / 8.32 mm

**Max. Ø Bundle** .700 " / 17.78 mm

**Min. Outside Ø** .330 "

**Min. Diameter Ø** 8.38

**Max. Outside Ø** .700 " / 17.78

**Min. Wire Size (in<sup>2</sup>)** .330 "

**Wire Size Range (AWG)** 4 to 4/0

## 4. Material and Specifications

---

**Material** Type 100, self laminating Vinyl, white (WH)

**Material Shortcut** 100

**Adhesive** Acryl / Acrylic

**Adhesive Operating Temperature** -51 °F to +200 °F (-46 °C to +93 °C)

**Curing Temperature** from +10 °C

<b>Operating Temperature</b>	-51 °F to +200 °F (-46 °C to +93 °C)
<b>ROHS Conformity</b>	

### **Logistic and Packaging**

---

<b>Packaging Type</b>	pack
<b>Pkg. Qty.</b>	90 / 90
<b>Carton Qty.</b>	1
<b>EAN code</b>	4031026172200
<b>Minimum Order Quantity</b>	90
<b>UPC</b>	08930604298

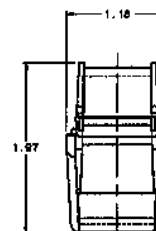
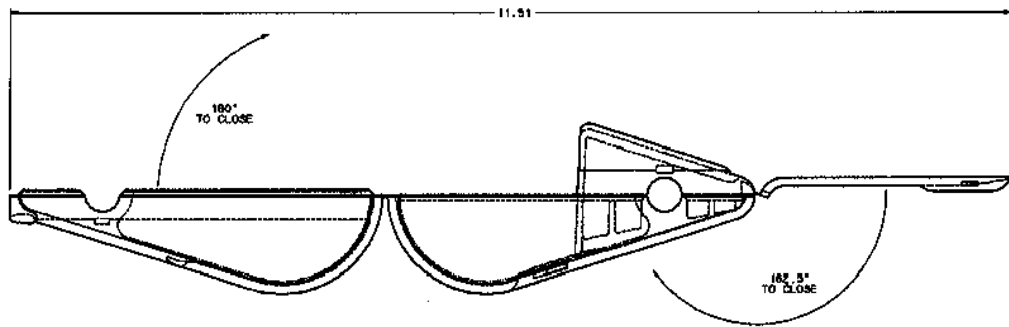
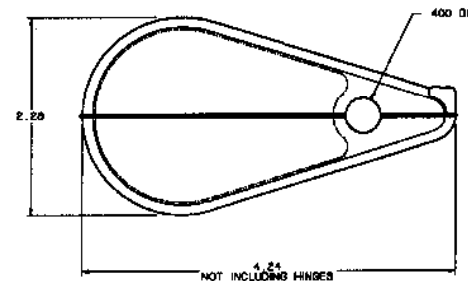
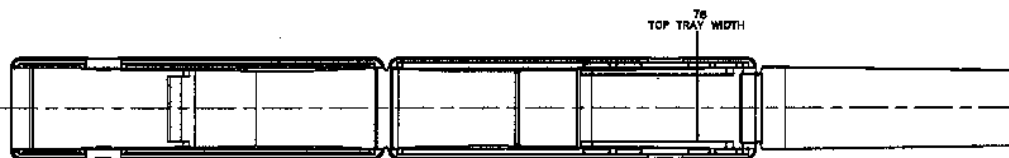
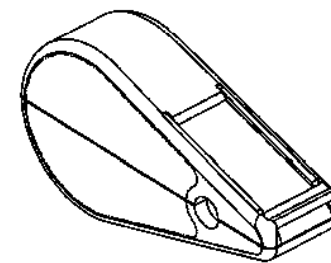
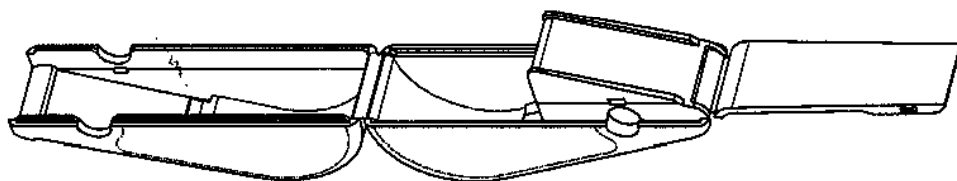

REDUCED  
NO SCALE

RO 101	3/4" X 1"
RO 175	3/4" X 3/4"
RO 512	3/4" X 1/2"
RO 514	3/4" X 5/16"
CATALOG NUMBER	WRITE-ON AREA WTL

DESIGN TEAM	INVENTOR(S)/DATE
6	018-D
1/5/98	600
OWN	DASH - REV
CHANGED	RELEASED
BY	DATE

**HellermannTyton**  
A SPIRENT Company

VERIFIED	UNITS	TOLERANCES	NAME
	<input checked="" type="checkbox"/> in	unless otherwise specified	DATE
<input type="checkbox"/> mm	.XXX ± 0.10	X*	DATE
<input type="checkbox"/> mm	.XX ± 0.02	< ± 2°	DATE
<input type="checkbox"/> mm			DATE
MATERIAL	POLYPROPYLENE		PART NAME
	COLOR BRIGHT YELLOW		
or engineering approved equivalent		plot date	scale
		1/5/98	FULL
		FORMAT C	drive S   sheet 1 of 1
		CUSTOMER DRAWING NUMBER	MHCST 30060 188

## Rite-On® Markers

HellermannTyton's Rite-On Markers are made from a flexible vinyl film and are used to mark wire and cable. The self-laminating labels have a clear tail which seals the legend under clear vinyl, maintaining the quality of the labels. The Rite-On markers are packaged in a reusable dispenser made from high impact plastic which is resistant to oils and grease.

### Product Features

- Easily and conveniently fits in a pants or shirt pocket.
- Once loaded, unit allows minimal label exposure to dust and moisture.
- Can be used with standard ball point pens or HellermannTyton nylon marking pens.
- Excess liner is easily cut-off by tearing it over the edge guide at the front of the unit.
- The dispenser can be reloaded over and over again, making it a cost-effective and efficient method of labeling.

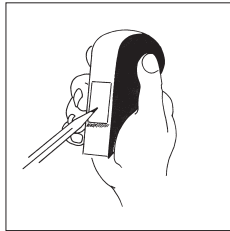

A special label window holds the label firm for easy marking.

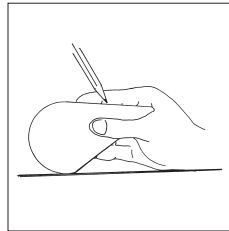

Can be held easily in the palm of the hand to provide a flat writing surface.

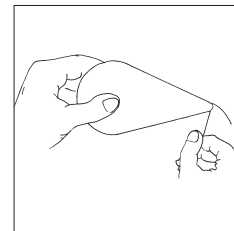

Label dispenses automatically when the liner is pulled from the front of the unit.

### Self-Laminating Labels and Dispenser

Product Selection									
Article No.	Part No.	Type	Width in. (mm)	Height of Write-On Area in. (mm)	Height of Label in. (mm)	Wire Size Range (AWG)	Min. Wire Size (in <sup>2</sup> )	Markers per Roll	Pkg. Qty.
590-01010	<b>RO101</b>	RO101	.75 " (19.05)	.875 " (22.22)	6.0 " (152.40)	4/0 on up	.70	40	1 roll
590-01750	<b>RO175</b>	RO175	.75 " (19.05)	.75 " (19.05)	3.0 " (76.2)	4 to 4/0	.330	90	1 roll
590-05120	<b>RO512</b>	RO512	.75 " (19.05)	.50 " (12.7)	1.875 " (47.62)	8 to 4 AWG	.263	150	1 roll
590-05140	<b>RO514</b>	RO514	.75 " (19.05)	.375 " (9.52)	1.25 " (31.75)	14 to 8 AWG	.053	200	1 roll
590-10000	<b>RO175WP</b>	RO175WP	.75 " (19.05)	.75 " (19.05)	3.0 " (76.2)	4 to 4/0	.330	90	1 roll

Dimensions are approximate and subject to technical changes. Use **Part No.** for ordering and **Type** for specification purposes.