

FC2.2AK2

Dual Adjustable Flat Ribbon Cable Clamp, Adhesive - Max Cable Width 2.0", PA66,
Telecom Gray, 50/pk

Article Number: 154-00017

Part Number: FC2.2AK2

Type: FC2.2A



Dual Adjustable Flat Ribbon Cable Clamps

Designed to route, protect and secure flat ribbon cables in computers, electronics, panels and components, this unique adjustable clamp will not damage sensitive wire and cable. The clamp will adjust and close to the exact height of the ribbon cable, using only as much force as needed to secure the cable. The clamp is releasable on demand and adjustable on both sides. The low profile design allows for use in confined areas where space is a premium.

The clamp is adjustable so that single or stacked cable can be routed. The "snap clamp" design of this flat ribbon cable clamp makes it an excellent choice for specification and installation.

Both adhesive backed and non-adhesive screw mount versions are available.

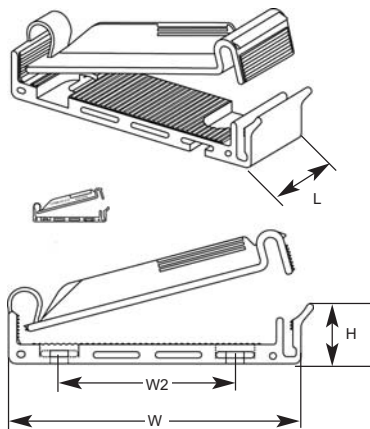
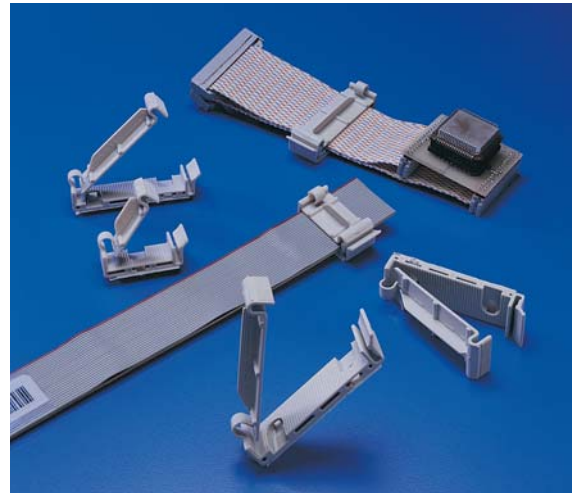

Material Data	
Material	Polyamide 6.6 (PA66)
Color	Telecom Gray
Operating Temperature	-40 °F to +185 °F (-40 °C to +85 °C)
Flammability	UL94 V2 (excluding adhesive)



Product Selection															
Article No.	Part No.	Type	Length (L)		Width (W)		Width (W2)		Height (H)		Mounting Hole Ø		Max Cable Width	Pkg. Qty.	
			in.	(mm)	in.	(mm)	in.	(mm)	in.	(mm)	in.	(mm)			in.
Adhesive															
154-00013	FC1.2AK2	FC1.2A	.75"	(19)	1.5"	(38.1)	n/a	n/a	.51"	(13.1)	n/a	n/a	1.2 "	(30.48)	50
154-00012	FC1.2AH4	FC1.2A	.75"	(19)	1.5"	(38.1)	n/a	n/a	.51"	(12.9)	n/a	n/a	1.2 "	(30.48)	500
154-00017	FC2.2AK2	FC2.2A	.75"	(19)	2.5"	(63.5)	n/a	n/a	.51"	(12.75)	n/a	n/a	2.0 "	(50.8)	50
154-00016	FC2.2AH4	FC2.2A	.75"	(19)	2.5"	(63.5)	n/a	n/a	.51"	(12.75)	n/a	n/a	2.0 "	(50.8)	500
Non-Adhesive															
154-00011	FC1.2K2	FC1.2	.75"	(19)	1.5"	(38.1)	1.62"	(41.15)	.51"	(12.9)	.138"	(6.0)	1.2 "	(30.0)	50
154-00010	FC1.2H4	FC1.2	.75"	(19)	1.5"	(38.1)	1.62"	(41.15)	.51"	(12.9)	.138"	(6.0)	1.2 "	(30.0)	500
154-00015	FC2.2K2	FC2.2	.75"	(19)	2.5"	(63.5)	1.5"	(38.1)	.51"	(12.95)	.138"	(6.0)	2.0 "	(50.8)	50
154-00014	FC2.2H4	FC2.2	.75"	(19)	2.5"	(63.5)	1.5"	(38.1)	.51"	(12.95)	.138"	(6.0)	2.0 "	(50.8)	500

Dimensions are approximate and subject to technical changes. Use **Part No.** for ordering and **Type** for specification purposes.