

Installation Instructions

FM2D50 Series

Two Circuit Electronic

24 Hour or 7 Day

Time Switches



APPLICATION

Time based control of lighting, ventilating, heating, cooling or other electrical loads in commercial and industrial applications. The FM2D50 time switches are programmable for 24-hour or 7-day schedules as well as a "8th day" or holiday schedule.

The FM2D50 series is intended for either surface or Flush panel mounting. Din rail mounting is also available by ordering the accessory model #MB-DIN. The control is completely enclosed in a plastic housing and includes a terminal cover and sub-base for installation and hard wiring.

It is also supplied with a clear plastic snap-on dust cover.

TECHNICAL DATA

Output – SPDT relay with dry contacts

- Switch Rating:
- 1/2 hp, 120V ac
 - 1hp, 240V ac
 - 16A, 277V ac resistive
 - 12A Ballast, 120V ac
 - 8A Ballast, 240V ac
 - 720 VA 240V ac Pilot Duty
 - 360 VA 120V ac Pilot duty
 - 1000W Tungsten, 240V ac
 - 600W Tungsten, 120V ac

3 year battery back-up

Supply voltages: Separate Models – 12VDC, 24VAC/DC, 120VAC, 208/240VAC, all 60Hz (refer to product label)

Shortest switch time: 1 minute

Ambient Temperature Range –20°F to 140°F (–28°C to 60°C)

AM/PM LCD display

Input Draw: 4VA

Screw terminal connections

1/4" quick connects

Accuracy ± 4 minutes per year

Agency Approvals: UL Recognized

Installation

To the installer:

1. Read operating instructions carefully.
2. Check the input and output ratings marked on the unit to make sure this product is suitable for your power supply and application.
3. Disconnect power supply prior to installation to prevent electrical shock.
4. Wire in accordance with National and Local electrical code requirements.

SURFACE MOUNTING

Remove cover, loosen two screws on opposite corners. Remove the housing that surrounds the time switch and the terminal cover away from the base. Remove timer module by pulling straight out.



Place screw through 3 mounting holes in base and screw to back panel or wall.

Wire in accordance with instructions. Replace terminal cover and push timer firmly onto base. Now replace housing and secure with screws.

PANEL MOUNTING

Cut a square hole 2-5/8" x 2-5/8" (66mm x 66mm) in the front of the panel. Insert the time switch through the opening. With a screwdriver, press down and turn out screws (A) until flanges are in position to fasten the unit in front panel, then release.

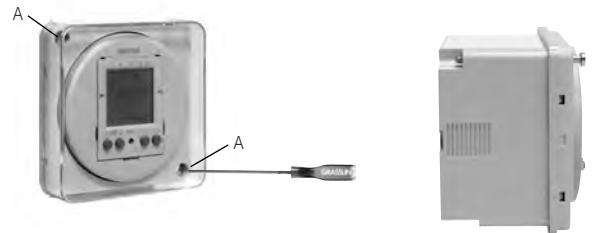

Use 1/4" quick connects and make connections in accordance with the wiring diagram shown and applicable code requirements.

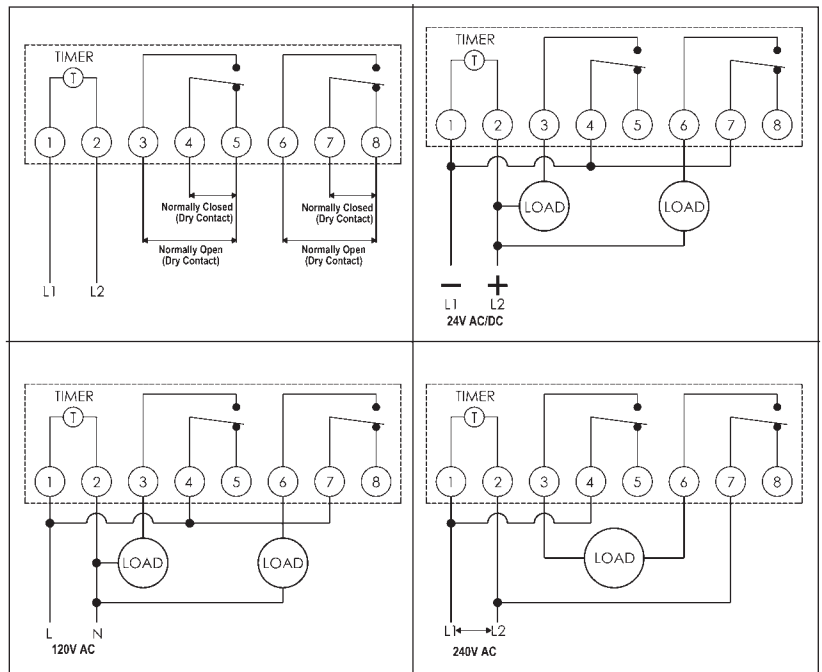

Program Schedules

Prog	CH1 ON/OFF	h	m	Day(s)	Holiday Program
Ex	On	7 am	30	Mon., Tue., Wed., Thurs, Fri.	No
1					
2					
3					
4					
5					
6					
7					
8					
9					
10					
11					
12					
13					
14					
15					
16					
17					
18					
19					
20					
21					
22					
23					
24					
25					
26					
27					
28					
29					
30					
31					
32					
33					
34					
35					
36					
37					
38					
39					
40					
41					
42					
43					
44					
45					
46					
47					
48					
49					
50					







Instruction Manual



50 memories time switch



page

	Safety Precautions	2
	Symbols, keys	3
	Initial Start - Up	4
	Program Structure	5
	Setting 24h or am/pm clock, time and weekday.....	7
	Change for Daylight Savings time	8
	Operating Mode	9
	Warranty	10

**Safety precautions**

- The connection and installation of electrical devices may only be carried out by a qualified electrician.
- Interventions in and changes to the device result in the voiding of the warranty claim.
- Observe your national regulations and the respective safety provisions.
- Switch-off commands have priority over switch-on commands.

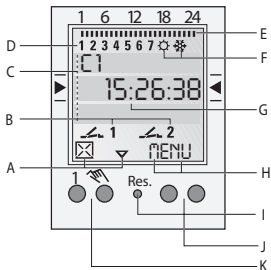

General information

- The middle communication line shows the selectable menu item. If confirmed with OK, this item is activated.
- Flashing texts or symbols require an entry.
- If no entries are made within the next 2 minutes, the clock reverts to Auto mode.

Function displays of the two left-hand buttons:

- △ scroll up in menu
- ▽ scroll down in menu
- ☒ Select/reject suggestion
- ✓ Select/accept suggestion
- + Press briefly = +1
Press and hold (approx. 2 sec) = +5
- Press briefly = -1
Press and hold (approx. 2 sec) = -5

Display

- A Function displays of the two left-hand buttons
- B Channel status displays
 - 1 = Channel 1 ON
 - 1 = Channel 1 OFF
 Channel 1 = C1, Channel 2 = C2
- C 3 communication lines for time display, menu items, entry prompts etc.
- D Day-of-week display
- E Overview of daily switching program
- F Display of summer/winter time
- G Operating voltage (permanently lit dots)
Reserve power operation (dots flash)
- H Function displays of the two right-hand buttons

Buttons

- I Reset
The programs are retained in the case of a reset. The date and time must be set again. Press reset button with a blunt object (pen).
- J Right-hand buttons
- K Left-hand buttons with manual switch function in Automatic mode

Function displays of the two right-hand buttons:

- MENU** Exits the Automatic mode and enters the Programming mode
- ESC** Press briefly = one step back
Press and hold (approx. 2 sec) = return to Automatic mode
- OK** Make selection and apply
- EDT** Change request in Read mode
- NO** Do not execute command
- YES** Execute command
- DEL** Delete

Initial start-up - selection of menu language

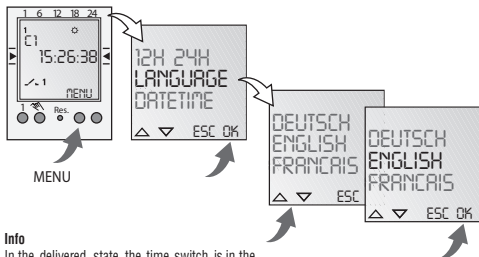

Info

In the delivered state the time switch is in the Auto mode with a preset time, date and the menu language English.

Prog.

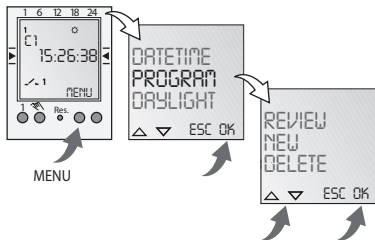

View, edit program

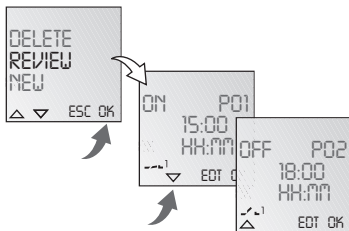

Info

- The program steps can be scrolled through with ▼▲.
- The respective program can be edited by pressing EDT. The procedure is the same as when creating a new program.

Delete all programs

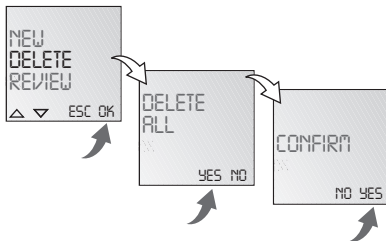

Info

- It is possible to delete all programs with YES
- By pressing NO, individual programs can be deleted.

Delete individual programs

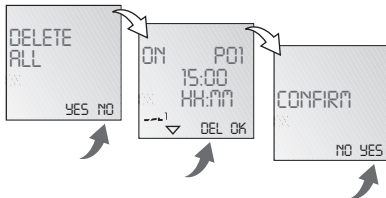

Info

When deleting individual programs, the corresponding program steps are deleted (e.g. P01 ON and P02 OFF).



Set date and time

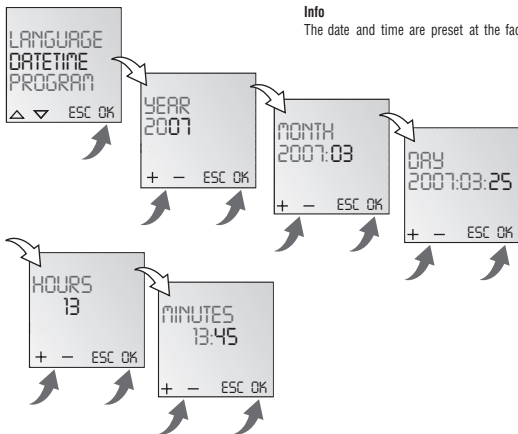

Info

The date and time are preset at the factory.

Set AM/PM (12-hour-) or 24-hour display

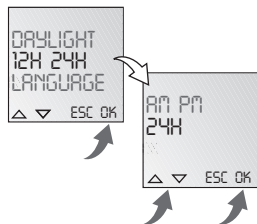



Change for Daylight Savings time

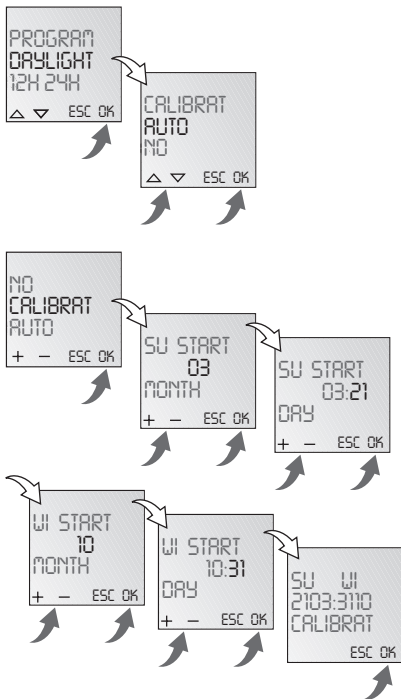

Info

The following settings are possible:

AUTO

Factory presetting of the published calendar dates. This is automatically recalculated for each year.

NO

No switchover

CALIBRAT

Programming for the start and ending date / or daylight savings time must be entered for this purpose.

The factory presetting is overwritten.

The programmed daylight savings time is automatically recalculated for each year.

The changeover takes place on the same specified day of the week in the same week of each month.

Example

03/21 Start Daylight Savings time
10/31 End Daylight Savings time

Operating mode

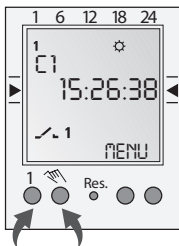

FIX ON: 

FIX OFF: 

AUTO (no display) programmed switching times

Info

Left-hand button = Channel 1

Right-hand button = Channel 2 (only with 2-channel version)

Press 1 x = FIX ON = continuous ON

Press 2 x = FIX OFF = continuous OFF

Press 3 x = return to Auto mode

WARRANTY

If within one (1) year from the date of purchase, this product fails due to a defect in material or workmanship, Intermatic Incorporated will repair or replace it, at its sole option, free of charge. This warranty is extended to the original household purchaser only and is not transferable. This warranty does not apply to: (a) damage to units caused by accident, dropping or abuse in handling, acts of God or any negligent use; (b) units which have been subject to unauthorized repair, opened, taken apart or otherwise modified; (c) units not used in accordance with instructions; (d) damages exceeding the cost of the product; (e) sealed lamps and/or lamp bulbs, LED's and batteries; (f) the finish on any portion of the product, such as surface and/or weathering, as this is considered normal wear and tear; (g) transit damage, initial installation costs, removal costs, or reinstallation costs.

INTERMATIC INCORPORATED WILL NOT BE LIABLE FOR INCIDENTAL OR CONSEQUENTIAL DAMAGES. SOME STATES DO NOT ALLOW THE EXCLUSION OR LIMITATION OF INCIDENTAL OR CONSEQUENTIAL DAMAGES, SO THE ABOVE LIMITATION OR EXCLUSION MAY NOT APPLY TO YOU. THIS WARRANTY IS IN LIEU OF ALL OTHER EXPRESS OR IMPLIED WARRANTIES. ALL IMPLIED WARRANTIES, INCLUDING THE WARRANTY OF MERCHANTABILITY AND THE WARRANTY OF FITNESS FOR A PARTICULAR PURPOSE, ARE HEREBY MODIFIED TO EXIST ONLY AS CONTAINED IN THIS LIMITED WARRANTY, AND SHALL BE OF THE SAME DURATION AS THE WARRANTY PERIOD STATED ABOVE. SOME STATES DO NOT ALLOW LIMITATIONS ON THE DURATION OF AN IMPLIED WARRANTY, SO THE ABOVE LIMITATION MAY NOT APPLY TO YOU.

This warranty service is available by either (a) returning the product to the dealer from whom the unit was purchased, or (b) mailing the product, along with proof of purchase, postage prepaid to the authorized service center listed below. This warranty is made by: Intermatic Incorporated/After Sales Service/7777 Winn Rd., Spring Grove, Illinois 60081-9698/815-675-7000 <http://www.intermatic.com> Please be sure to wrap the product securely to avoid shipping damage.

INTERMATIC INCORPORATED
SPRING GROVE, IL 60081-9698

158--00676