

71600-040LF

[Assistant](#)

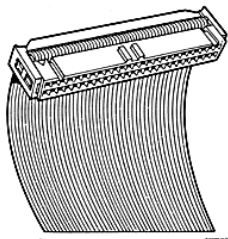

71600-040LF - Quickie®

**Receptacle -Double row - 40 Positions
- 2.54 mm (0.1 in.)**

[Email Datasheet](#) [Print Datasheet](#)

FCI Brings You More

- [Contact our sales/technical support](#)
- [Sample request](#)
- € [Price request](#)
- [Check distributor stock](#)

ACTIVE

[Customer Drawing](#)



Electronics division

Mating Half



71918-140LF Double row, 40 Positions, 2.54 mm (0.1 in.), Vertical, Eject Latch Header 0.76 µm (30 µin.) Gold or GXT™ Plating



71922-140LF Double row, 40 Positions, 2.54 mm (0.1 in.), Right Angle, Eject Latch Header 0.76 µm (30 µin.) Gold or GXT™ Plating

Download document

Technical Resources

- [> 3D IGES](#)
- [> RoHS qualification documents](#)
- [> 3D STEP](#)
- [> Product Specification](#)

Literature

- [> Quickie™ CTB connectors for PIP Processes](#)
- [> Basics+ Product Focus](#)
- [> Basics+ Brochure](#)
- [> Connectors for Medical Devices Brochure](#)
- [> Connector Overview Brochure](#)

Application Tooling

- [> Asia Pacific Application Tooling](#)
- [> Americas Application Tooling](#)
- [> Europe Application Tooling](#)

Specifications

Direct Links ...>

- [Cross Reference](#) ✕
- [RoHS/LF P/N search](#) 🌿
- [Document & Drawing search](#)
- [Application tooling](#)

Services ...>

- [Contact us](#)
- [Distributor list](#)
- [Pricing request](#)
- [Order samples](#)

Literature ...>

- [Brochures & catalogs](#)
- [Product documentation](#)
- [Technical library](#)

General	
Insulation Displacement Contact (IDC)	IDC Receptacle
Number of contacts (Total)	40
Number of rows	2
Polarization	Center and Dual
Strain Relief	Standard
Style	Standard Single Beam
Termination Style	IDC
Application Equipment	QP-104 QP-112 QP-106
Mating half	Mates with shrouded Eject Latch Header Latch 1
Electrical	
Current rating	1 amp Continuous
Resistance (Contact)	15 m ohms max.
Resistance (Insulation)	50000 M ohms
Voltage rating	1000V AC rms
Physical	
Color (Housing)	Grey
Material (Contact)	Phosphor Bronze
Material (Housing)	Glass - Filled Thermoplastic Polyester
Plating (Contact area)	0.76 µm (30 µin.) Gold
Underplating (Contact)	1.27 µm (50 µin.) Nickel
Flammability rating	UL 94 V-0
Temperature (Range)	-65°C to +105°C
Approvals / Certifications	
Approvals / Certifications	UL and CSA Approved
Other Features	
Packaging (Type)	Tube

PRODUCT NUMBER

71600-YXXLF

LEAD FREE, SEE NOTE 6

TOTAL NB OF POSITION 04 TO 64
SEE SHEET 2

OPTIONAL STRAIN RELIEF
SEE SHEET 2

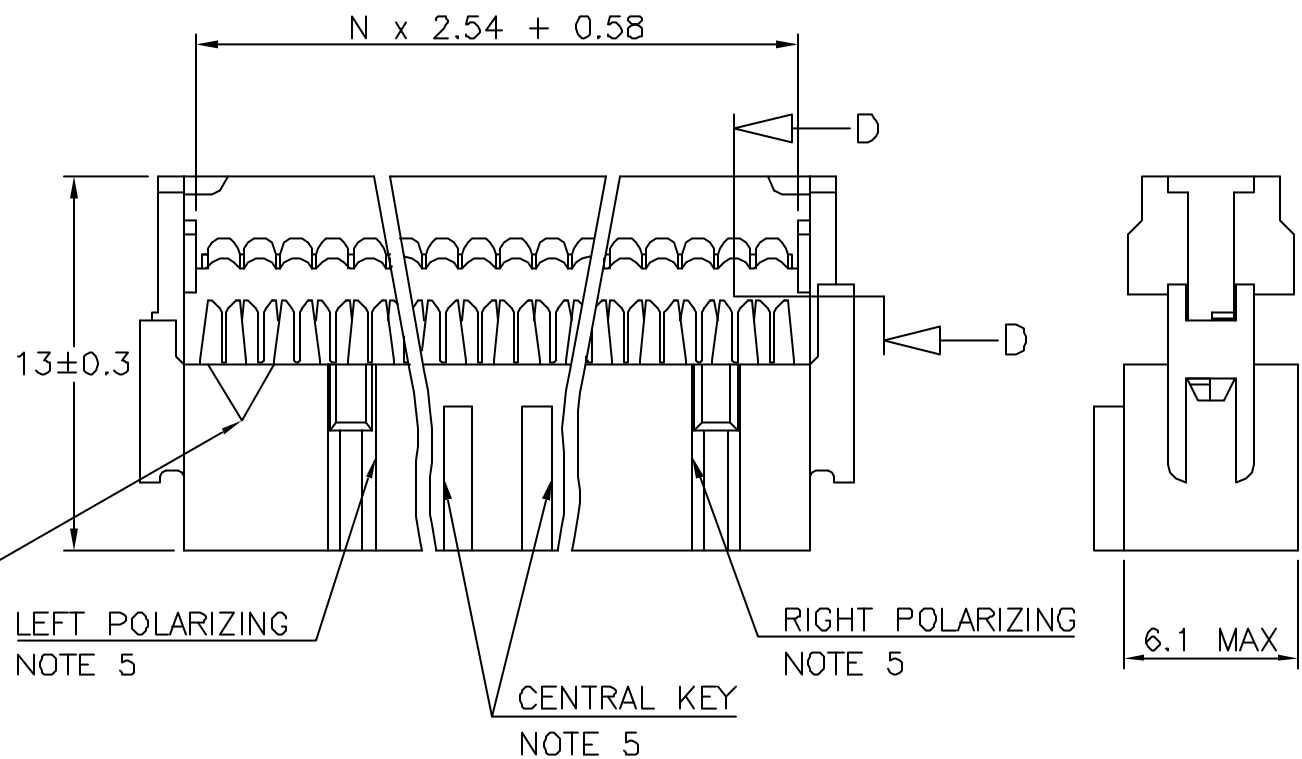

TRIANGLE INDICATES
POSITION 1
NOTE 5

LEFT POLARIZING
NOTE 5

RIGHT POLARIZING
NOTE 5

CENTRAL KEY
NOTE 5

6.1 MAX

NOTES:

- 1 - PLASTIC MAT'L : GLASS FILLED HIGH TEMPERATURE THERMOPLASTIC. UL94V-0 COLOR: GREY
- 2 - PIN MATERIAL : PHOSPHOR BRONZE
- 3 - PRODUCT PACKAGED IN TUBES.
- 4 - TO DETERMINE DIMENSIONS :
N = NUMBER OF POSITIONS
EXAMPLE : 8 POS $N \times 2.54 = 20.32\text{mm}$
- 5 - 2x5, 2x6, 2x7 HAVE NO LEFT POLARIZING SLOT.
- 2x2, 2x3 WITH CENTRAL KEY HAVE NO TRIANGLE, NO LEFT AND RIGHT POLARIZING SLOT.
- 2x2 WITHOUT CENTRAL KEY HAS NO LEFT AND RIGHT POLARIZING SLOT.
- 2x3, 2x4 WITHOUT CENTRAL KEY HAVE NO LEFT POLARIZING SLOT
- 2x4 WITH CENTRAL KEY HAVE NO LEFT AND RIGHT POLARIZING SLOT
- 6 - THIS PRODUCT MEETS EUROPEAN UNION DIRECTIVES AND OTHER COUNTRY REGULATIONS AS PER GS-22-008.
PACKAGING SPECIFICATION AS PER GS-14-920.

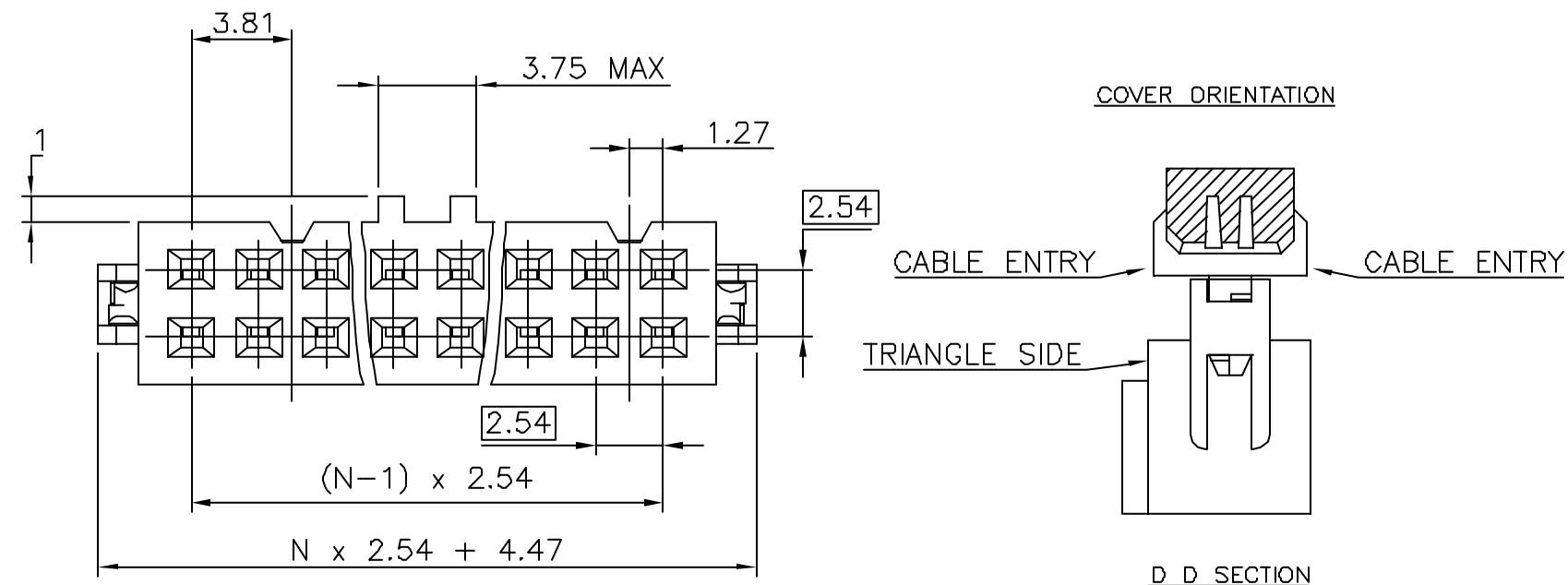

COVER ORIENTATION

CABLE ENTRY

CABLE ENTRY

TRIANGLE SIDE

D D SECTION

mat'l. code				surface		tolerance		projection		product family	
SEE NOTES				ISO 1302		ISO 406 ISO 1101		mm		2.54MM IDC	
Ltr	ecn	na	dr	date		tolerances unless otherwise specified		mm		title	
AG	F04-0330	LMU	04.09.01			X.X ±0.3				QUICKIE III FEM	
AH	F05-0109	JCO	05.01.17			X.XX ±0.13				0.76µm Au	
AJ	F05-0171	LMU	05.04.07			X.XXX ±0.05		scale 5:1		dwg no	
AK	F05-0180	LMU	05.04.22	dr	D.LE	01.01.24				sheet 1 of 2	
AL	F06-0270	LMU	06.09.12	enr	P.NZ	01.01.24				size	
AM	F06-0274	LMU	06.09.25	chr	JF.N	01.01.24				A3	
				appd	P.NZ	01.01.24				type	
										CUSTOMER Drawing	
sheet	revision	AM	AE								
index	sheet	1	2								

CORE RANGE	
STRAIN RELIEF	Nbr OF POSITIONS
0/1	04
0/1	06
0/1	08
0/1	10
0/1	14
0/1	16
0/1	18
0/1	20
0/1	24
0/1	26
0/1	30
0/1	34
0/1	40
0/1	50
0/1	60
0/1	64
PLATING 0.76µm GOLD ON CONTACT AREA 1.27 µm Ni REMAINDER OF PRODUCT	

CATALOGUE RANGE	
STRAIN RELIEF	Nbr OF POSITIONS
2/6	04
2/6	06
2/6	08
2/6	10
2/6	14
2/6	16
2/6	18
2/6	20
2/6	24
2/6	26
2/6	30
2/6	34
2/6	40
2/6	50
2/6	60
2/6	64
PLATING 0.76µm GOLD ON CONTACT AREA 1.27 µm Ni REMAINDER OF PRODUCT	

624
304
204 / 224
004
DASHES NOT AVAILABLE

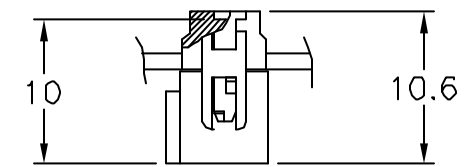

WITHOUT STRAIN RELIEF

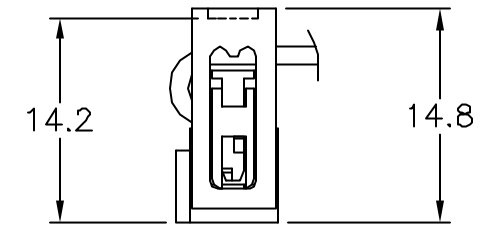

WITH LOW PROFILE STRAIN RELIEF

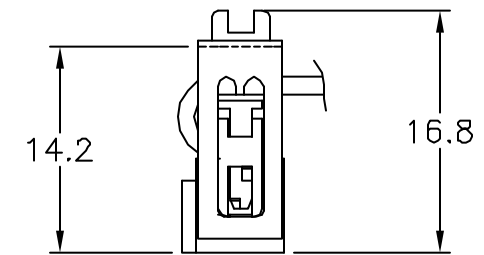

WITH STANDARD STRAIN RELIEF

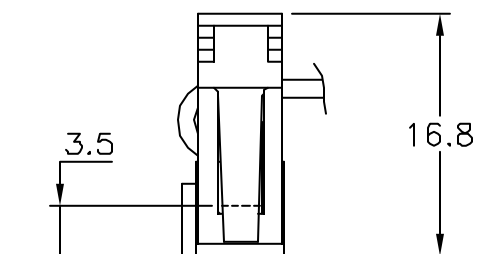

WITH LATCHING STRAIN RELIEF

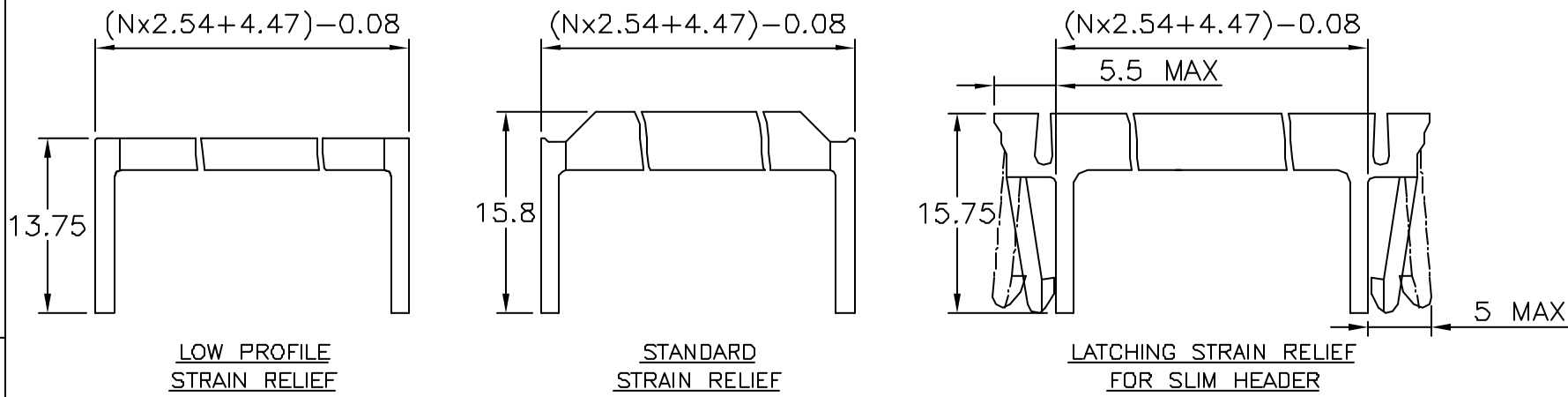

LOW PROFILE STRAIN RELIEF

STANDARD STRAIN RELIEF

LATCHING STRAIN RELIEF FOR SLIM HEADER

71600-6YYLF	●					●
71600-3YYLF		●	●			
71600-2YYLF	●				●	
71600-1YYLF	●			●		
71600-0YYLF	●		●			
PRODUCT NUMBER	WITH	WITHOUT	STANDARD	WITHOUT	LOW PROFILE	LATCHING
	CENTRAL KEY		STRAIN RELIEF			

mat'l. code				surface	tolerance	projection	product family
				ISO 1302	ISO 406 ISO 1101		QUICKIE
ltr	ecn no	dr	date	tolerances unless otherwise specified			title
X	F70666	AAN	97.11.05	angles	Linear	mm	IDC RECEIPT DR
Y	F10121	DLE	01.01.24			scale N/A	
AA	F10199	GCO	01.04.26				
AB	F03019	DLE	03.01.23	dr	D.LE	01.01.24	dwg no
AC	F05-0180	LMU	05.04.22	engr	P.NZ	01.01.24	sheet 2 of - size
AD	F06-0270	LMU	06.09.12	chr	JF.N	01.01.24	71600 A3
AE	F06-0274	LMU	06.09.25	appd	P.NZ	01.01.24	type
sheet index	revision sheet						CUSTOMER Drawing

FCJ	FCJconnect.com
-----	----------------