

Direct Links

- [Cross Reference](#)
- [RoHS/LF P/N search](#)
- [Document & Drawing search](#)
- [Application tooling](#)

Services

- [Contact us](#)
- [Distributor list](#)
- [Pricing request](#)
- [Order samples](#)

Literature

- [Brochures & catalogs](#)
- [Product documentation](#)
- [Technical library](#)

Start > Search=65043-032LF* > **65043-032LF**

65043-032LF

[Assistant](#)

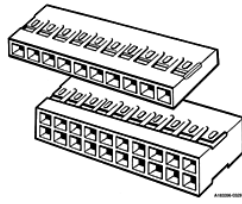

65043-032LF - Mini-PV™, Basics+

**2.54 x 2.54 mm (0.1 x 0.1 in.)
Centerline Crimp-to-Wire PV
Receptacle Housing, Double Row**

ACTIVE

[Customer Drawing](#)

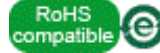

Electronics division

[Email Datasheet](#) [Print Datasheet](#)

FCI Brings You More

- [Contact our sales/technical support](#)
- [Sample request](#)
- € [Price request](#)
- [Check distributor stock](#)

Mating Half



69168-110HLF2 Wall Shrouded Header -
Through Hole - Double row - 10
Positions 2.54 mm - Vertical



78207-110HLF2 Wall Shrouded Header -
Through Hole - Double row - 10
Positions 2.54 mm - Right Angle



67996-110HLF Unshrouded header,
Through Hole, Double row, 10
Positions, 2.54 mm Pitch, Vertical, 5.84
mm (0.23 in.) Mating, 2.41 mm (0.095
in.) Tail



68020-110HLF Unshrouded header,
Through Hole, Double row, 10
Positions, 2.54 mm Pitch, Right Angle,
5.84 mm (0.23 in.) Mating, 2.41 mm
(0.095 in.) Tail

Download document

Technical Resources

- [> 3D IGES](#)
- [> RoHS qualification documents](#)
- [> Application Specification](#)
- [> 3D STEP](#)
- [> Product Specification](#)
- [> 3D PROE](#)
- [> Application Specification](#)

Literature

- [> Basics+ Brochure](#)
- [> Connectors for Medical Devices Brochure](#)
- [> Connector Overview Brochure](#)
- [> Basics+ Product Focus](#)
- [> PV@ Connector system](#)
- [> Contacts & Latch Housings Product Focus](#)

Application Tooling

- [> Asia Pacific Application Tooling](#)
- [> Americas Application Tooling](#)
- [> Europe Application Tooling](#)

Specifications

General	Dimensional	Electrical	Physical	Approvals / Certifications	Other Features
General					
Number of contacts				10	
Number of rows				2	
Orientation				Vertical	
Product Type				Crimp-to-Wire Housing	
Polarization (Key)				No	
Mating half				Mates with 0.64 mm (0.025 in.) Square Pin with Length of 5.33 mm (0.21 in.) min. to 6.1 mm (0.24 in.) max.	
Dimensional					
Length (Mating pin)				5.33 mm (0.21 in.) to 6.1 mm (0.24 in)	
Size (Wire)				22 to 36 AWG	
Electrical					
Resistance (Insulation)				100000 M ohms	
Voltage rating				1000V rms	
Physical					
Color (Housing)				Black	
Material (Housing)				PPE+PS	
Temperature (Range)				-40°C to +105°C	
Approvals / Certifications					
Approvals / Certifications				UL and CSA Approved	
Other Features					
Accessory				Polarization Plug 65307-001LF	
Packaging (Type)				Bag	
Comments				PV™ Contact Removal Tool: Part Number HT-0080	

PRODUCT NUMBER
SEE TABLE

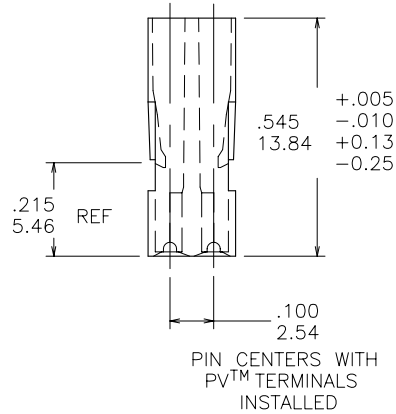
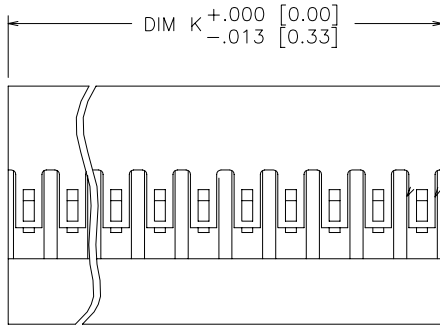



NOTES

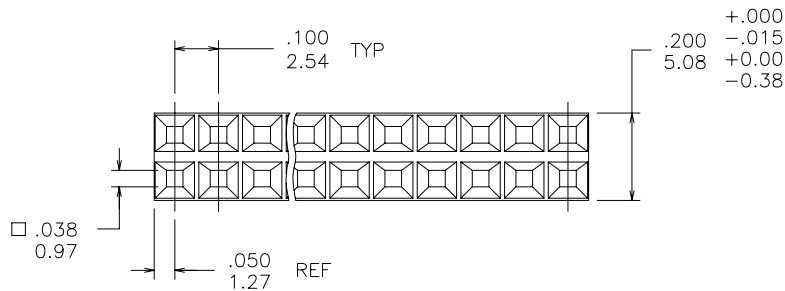

- ①. MOLDING MAT'L: MODIFIED POLYPHENYLENE ETHER. COLOR: BLACK, MEETING UL 94V-0.
2. PIN LENGTH TO BE .210/5.33 MIN. RECOMMENDED PIN LENGTH IS .225±.015/5.72±0.38.
3. FOR TERMINAL APPLICATION SEE TA-531.
4. TERMINALS MUST BE CRIMPED PROPERLY FOR SATISFACTORY LATCHING. SEE TA-75 FOR CRIMPING INSTRUCTIONS. PRODUCT SPECIFICATION: BUS-12-067
5. THIS HOUSING IS INTENDED FOR USE WITH MINI PV™ TERMINAL WITH 22-36 GAUGE WIRE.
- ⑥. ALL MARKINGS EXCEPT LOGO USE 6 POINT TYPE (APPROX .06/1.52 HIGH) AND WHITE INK (MARKEM #8829 OR EQUIV.) WHEN MARKING CAVITIES. NUMERALS OR LETTERS ARE TO BE CENTERED ON RESPECTIVE CAVITIES, UNLESS OTHERWISE NOTED.
- ⑦. LOGO TO BE POSITIONED IN THIS AREA SO THAT IT IS READ FROM THE SAME EDGE OF THE CONNECTOR AS THE OTHER MARKINGS.
- ⑧. ALL MARKINGS FOR MILITARY PART NUMBERS ARE TO BE PER MIL-STD-1285 SEE TABULATION.
- ⑨. PLACE DESC P/N AND CAGE NO. ON PACKAGING LABEL. PRODUCT LENGTH IS TOO SMALL TO MARK PRINT.
10. PRODUCT MEETS EUROPEAN UNION DIRECTIVES AND OTHER COUNTRY REGULATIONS AS DESCRIBED IN GS-22-008.
11. THE PRODUCT IS NOT INTENDED TO BE EXPOSED TO MANUFACTURING SOLDER PROCESS.
- ⑫. EUROPEAN CUSTOMERS SHOULD ORDER PART NUMBERS WITH AN 'E' SUFFIX AS SHOWN IN TABLE TO CONTINUE TO BE SUPPLIED BY THE EUROPEAN PLANT. SEE DRAWING 65043EUR.

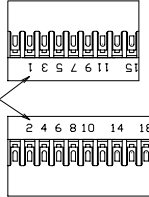
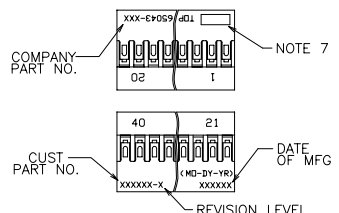
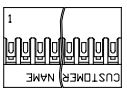
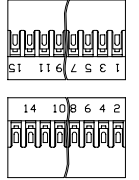
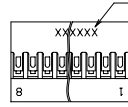
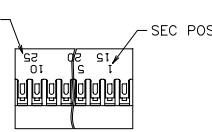

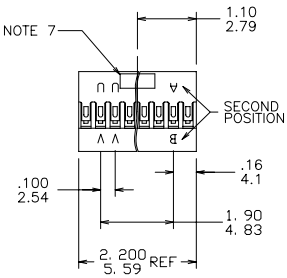
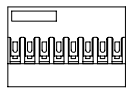
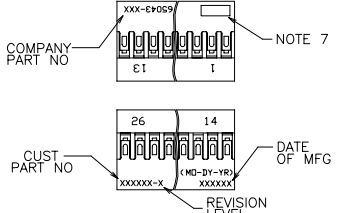
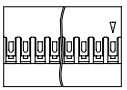
mat'l. code		surface		tolerance		projection		product family	
SEE NOTE 1		ASME Y14.5		ASME Y14.5		INCH/MM		PV HOUSINGS	
ltr	ec'n no	dr	date	tolerances unless otherwise specified		INCH/MM		title	
BF	V07-0483	HTB	2007-07-24	angles	XX*01/XX*3	INCH/MM		MINI LATCH HOUSING	
BG	V08-0022	HTB	2008-01-15	lines	XXX*005/XXX*13	scale 2.5:1		DOUBLE ROW .100 [2.54] CC	
-	-	-	-	0°±2'	XXXX*0020/XXX*051			dwg no	
BB	V05-0712	DAI	2005-07-27	dr	M. CLOUSER	FCI		sheet 1 of 11	
BC	V06-0407	HTB	2006-04-27	engr	C. TREXLER			size	
BD	V06-0549	HTB	2006-06-12	chr	C. TREXLER			A4	
BE	V06-0886	HTB	2006-08-31	appd	C. TREXLER			type	
sheet	revision	BG	BG	BG	BG	BG	BG	BG	Product Customer Drawing
index	sheet	1	2	3	4	5	6	7	

<p>PRODUCT NUMBER SEE TABLE</p>	<p>MARK POSITION NUMBERS AS SHOWN TO LENGTH OF PART.</p>  <p>SECOND POSITION</p>	<p>MARK TOP, CO. LOGO, CUST P/N REV LEVEL, DATE OF MFG, SECOND & NEXT TO LAST POS ON BOTH SIDES IN WHITE AS SHOWN.</p>  <p>COMPANY PART NO.</p> <p>CUST PART NO.</p> <p>NOTE 7</p> <p>DATE OF MFG</p> <p>REVISION LEVEL</p>	<p>MARK CAVITIES AS SHOWN.</p>  <p>ELEVENTH POS</p> <p>SEC POS</p> <p>MARK SECOND CAVITY AS SHOWN.</p> 
<p>MARK POSITION ONE AND CUST. NAME AS SHOWN.</p>  <p>STYLE A</p>	<p>MARK POSITIONS AS SHOWN.</p>  <p>STYLE D</p> <p>STYLE E</p>	<p>MARK CUST P/N & FIRST & LAST POS (1 SIDE ONLY) AS SHOWN</p>  <p>STYLE H</p>	<p>MARK TOP, CO. LOGO, CUST P/N REV LEVEL, DATE OF MFG, SECOND & NEXT TO LAST POS ON BOTH SIDES IN WHITE AS SHOWN.</p>  <p>COMPANY PART NO.</p> <p>CUST PART NO.</p> <p>NOTE 7</p> <p>DATE OF MFG</p> <p>REVISION LEVEL</p> <p>STYLE J</p> <p>STYLE L</p>
<p>MARK LOGO AND POSITIONS AS SHOWN</p>  <p>NOTE 7</p> <p>1.10 2.79</p> <p>SECOND POSITION</p> <p>.100 2.54</p> <p>.16 4.1</p> <p>1.90 4.83</p> <p>2.200 5.59 REF</p> <p>STYLE B</p>	<p>MARK CUSTOMERS P/N AND REVISION LEVEL IN AREA SHOWN.</p>  <p>STYLE F</p>	<p>MARK ARROW IN WHITE AS SHOWN ON SURFACE OPPOSITE GATE.</p>  <p>STYLE C</p>	<p>MARK SECOND CAVITY AS SHOWN.</p>

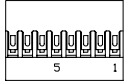
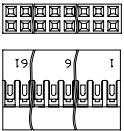
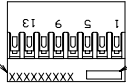
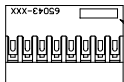
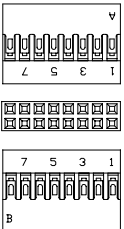
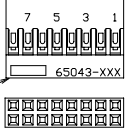
mat'l. code		surface		tolerance		projection		product family	
SEE NOTE 1		ASME Y14.5		ASME Y14.5				PV HOUSINGS	
ltr	ecn no	dr	date	tolerances unless otherwise specified					
BG				angles	XX+01/XX+3		INCH/MM		title
				linear	XXX+005/XXX+13		scale 1:1		MINI LATCH HOUSING
				0°±2'	XXXX+0020/XXX+051				DOUBLE ROW .100 [2.54] CC
		dr	M. CLOUSER	1990-01-31					
		engr	C. TREXLER	1990-01-31					
		chr	C. TREXLER	1990-01-31					
		appd	C. TREXLER	1990-01-31					
sheet	revision								
index	sheet								

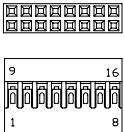
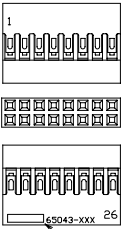
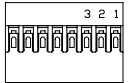
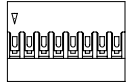
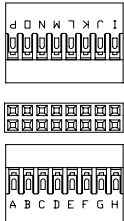
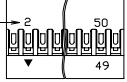
<p>PRODUCT NUMBER SEE TABLE</p>	<p>MARK CHARACTERS AS SHOWN IN WHITE.(ONE SIDE ONLY)</p>  <p>STYLE Q</p>	<p>MARK CHARACTERS ONE SIDE ONLY.</p>  <p>STYLE U</p>	
<p>MARK CO. LOGO, CUST P/N AND FIRST & LAST POS PLUS EVERY FOURTH POS IN WHITE AS SHOWN (ONE SIDE ONLY)</p> <p>NOTE: HOUSING WITH 16 POS OR LESS WILL NOT HAVE CO. LOGO INCLUDED.</p>  <p>STYLE M</p>	<p>CO. LOGO AND P/N MARKED AS SHOWN. NO CO. P/N ON HOUSING LESS THAN 2 X 8.</p>  <p>STYLE R</p>	<p>NUMBER EVERY OTHER POSITION AND SIDE A AND B AS SHOWN.</p>  <p>STYLE V</p>	<p>MARK POSITION IDENTIFICATION AS SHOWN.</p>  <p>STYLE Y</p>
<p>MARK CAV IDENTIFICATION APPROX AS SHOWN.(ONE SIDE ONLY)</p>  <p>STYLE N</p>	<p>MARK CHARACTERS IN WHITE AS SHOWN.</p>  <p>STYLE S</p>	<p>MARK POS 1 & 26 CO. LOGO & P/N AS SHOWN SEE NOTE 6.</p>  <p>STYLE W</p>	<p>MARK POSITIONS 1, 2 AND 3 ONLY SEE NOTE 6</p>  <p>STYLE Z</p>
<p>MARK CAVITY AS SHOWN WITH ARROW.</p>  <p>STYLE O</p>	<p>MARK CHARACTERS IN WHITE AS SHOWN.</p>  <p>STYLE T</p>		
<p>MARK CHARACTERS AS SHOWN IN WHITE.(ONE SIDE ONLY)</p>  <p>STYLE P</p>			

mat'l. code SEE NOTE 1		surface ASME Y14.5	tolerance ASME Y14.5	projection 	product family PV HOUSINGS
ltr	ecn no	dr	date	tolerances unless otherwise specified	title MINI LATCH HOUSING DOUBLE ROW .100 [2.54] CC
BG				angles XX*01/XX*3 XXX*005/XXX*13 XXXX*0020/XXX*051	scale 1:1
		dr	M. CLOUSER	1990-01-31	dwg no
		engr	C. TREXLER	1990-01-31	sheet 3 of 11
		chr	C. TREXLER	1990-01-31	size 65043
		appd	C. TREXLER	1990-01-31	A4
sheet index	revision sheet				type Product Customer Drawing

<p>PRODUCT NUMBER SEE TABLE</p> <p>NUMBER TO BE LOCATED IN CENTER OF RESPECTIVE POSITION</p> <p>STYLE AA</p>	<p>MARK FIRST AND LAST POSITION WITH APPROPRIATE NO. ALL EVEN # POSITIONS ON SAME SIDE OF HOUSING</p> <p>CAVITY #2</p> <p>CAVITY #1</p> <p>OTHER SIDE UP</p> <p>STYLE AD</p>	<p>NUMBER EVERY OTHER POSITION AND SIDE A AND B AS SHOWN. MARK CHARACTERS IN WHITE.</p> <p>STYLE AG</p>	<p>MARK "THIS SIDE UP" AND POSITION NUMBERS 13 & 24 AS SHOWN IN .060/1.52 HIGH CHARACTERS.</p> <p>STYLE AK</p>
<p>MARK ENTIRE SURFACE WHITE</p> <p>STYLE AB</p>	<p>MARK FIRST AND LAST POSITION WITH APPROPRIATE NO. BOTH SIDES ALL EVEN # POSITIONS ON SAME SIDE OF HOUSING</p> <p>CAVITY #2</p> <p>CAVITY #1</p> <p>TO DRIVE</p> <p>STYLE AE</p>	<p>MARK NUMBERS IN WHITE.</p> <p>STYLE AH</p>	<p>MARK FIRST AND LAST POSITION WITH APPROPRIATE NO. ON ONE SIDE, ALSO PRINT "THIS SIDE UP-1" AS SHOWN.</p> <p>STYLE AL</p>
<p>IDENTIFY POSITIONS 1, 6, 13 WITH WHITE CHARACTERS LOCATED AS SHOWN.</p> <p>STYLE AC</p>	<p>MARK HOUSING (ONE SIDE ONLY) EVERY SECOND POSITION WITH ODD NUMBERS TO LENGTH OF PART DO NOT MARK END POSITIONS</p> <p>SECOND POSITION</p> <p>STYLE AF</p>	<p>MARK FIRST AND LAST POSITION BOTH SIDES AS SHOWN. TO LENGTH OF PART.</p> <p>STYLE AJ</p>	

mat'l. code SEE NOTE 1		surface ASME Y14.5	tolerance ASME Y14.5	projection 	product family PV HOUSINGS
ltr	ecn no	dr	date	tolerances unless otherwise specified	title MINI LATCH HOUSING DOUBLE ROW .100 [2.54] CC
BG				angles XX*.01/XX*.3 XXX*.005/XXX*.13	scale 1:1
				linear XXXX*.0020/XXX*.051	dwg no 65043
		dr	M. CLOUSER	1990-01-31	sheet 4 of 11
		engr	C. TREXLER	1990-01-31	size A4
		chr	C. TREXLER	1990-01-31	type Product Customer Drawing
		appd	C. TREXLER	1990-01-31	
sheet index	revision sheet				

PRODUCT NUMBER
SEE TABLE

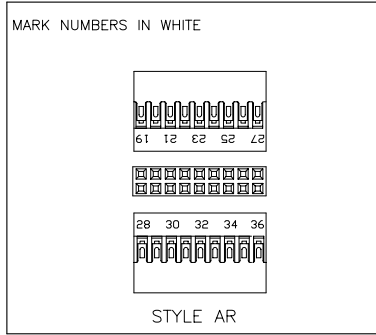
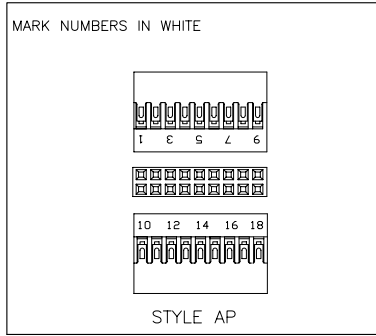
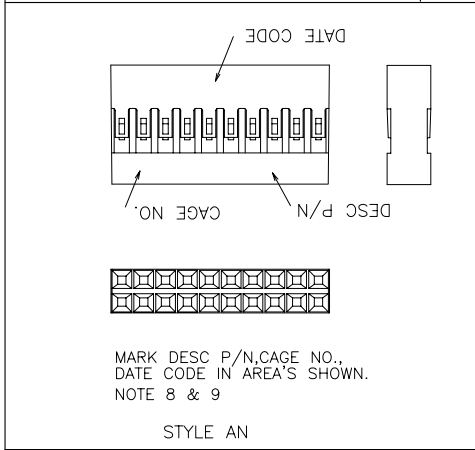
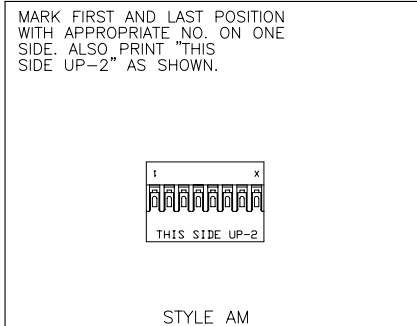

mat'l. code		surface		tolerance		projection		product family	
SEE NOTE 1		ASME Y14.5		ASME Y14.5				PV HOUSINGS	
ltr	ecn no	dr	date	tolerances unless otherwise specified		INCH/MM		title	
BG				angles	.XX+01/XX+3	1:1		MINI LATCH HOUSING	
				linear	XXX+005/XX+13	scale		DOUBLE ROW .100 [2.54] CC	
				0'±2'	XXXX+0020/XXX+051	1:1		dwg no	
				dr	M. CLOUSER	1990-01-31		sheet 5 of 11	
				engr	C. TREXLER	1990-01-31		size	
				chr	C. TREXLER	1990-01-31		A4	
				appd	C. TREXLER	1990-01-31		type	
sheet index		revision sheet						Product Customer Drawing	



PRODUCT NO.	NO OF POS	DIM K	EUROPEAN VERSION-NOTE 12
65043-001LF	2 X 36	3.600/91.44	65043-001ELF
65043-002LF	2 X 35	3.500/88.90	65043-002ELF
65043-003LF	2 X 34	3.400/86.36	65043-003ELF
65043-004LF	2 X 33	3.300/83.82	65043-004ELF
65043-005LF	2 X 32	3.200/81.28	65043-005ELF
65043-006LF	2 X 31	3.100/78.74	65043-006ELF
65043-007LF	2 X 30	3.000/76.20	65043-007ELF
65043-008LF	2 X 29	2.900/73.66	65043-008ELF
65043-009LF	2 X 28	2.800/71.12	65043-009ELF
65043-010LF	2 X 27	2.700/68.58	65043-010ELF
65043-011LF	2 X 26	2.600/66.04	65043-011ELF
65043-012LF	2 X 25	2.500/63.50	65043-012ELF
65043-013LF	2 X 24	2.400/60.96	65043-013ELF
65043-014LF	2 X 23	2.300/58.24	65043-014ELF
65043-015LF	2 X 22	2.200/55.88	65043-015ELF
65043-016LF	2 X 21	2.100/53.34	65043-016ELF
65043-017LF	2 X 20	2.000/50.80	65043-017ELF
65043-018LF	2 X 19	1.900/48.26	65043-018ELF
65043-019LF	2 X 18	1.800/45.72	65043-019ELF
65043-020LF	2 X 17	1.700/43.18	65043-020ELF
65043-021LF	2 X 16	1.600/40.64	65043-021ELF
65043-022LF	2 X 15	1.500/38.10	65043-022ELF
65043-023LF	2 X 14	1.400/35.56	65043-023ELF
65043-024LF	2 X 13	1.300/33.02	65043-024ELF
65043-025LF	2 X 12	1.200/30.48	65043-025ELF
65043-026LF	2 X 11	1.100/27.94	65043-026ELF
65043-027LF	2 X 10	1.000/25.40	65043-027ELF
65043-028LF	2 X 9	.900/22.86	65043-028ELF
65043-029LF	2 X 8	.800/20.32	65043-029ELF
65043-030LF	2 X 7	.700/17.78	65043-030ELF
65043-031LF	2 X 6	.600/15.24	65043-031ELF
65043-032LF	2 X 5	.500/12.70	65043-032ELF
65043-033LF	2 X 4	.400/10.16	65043-033ELF
65043-034LF	2 X 3	.300/7.62	65043-034ELF
65043-035LF	2 X 2	.200/5.08	65043-035ELF

mat'l. code		surface		tolerance		projection		product family	
SEE NOTE 1		ASME Y14.5		ASME Y14.5				PV HOUSINGS	
ltr	ecn no	dr	date	tolerances unless otherwise specified		INCH/MM		title	
BG				angles	.XX+01/XX+3			MINI LATCH HOUSING	
				linear	XXX+005/XXX+13	scale 1:1		DOUBLE ROW .100 [2.54] CC	
				0'±2'	XXXX+0020/XXX+051			dwg no	
				dr	M. CLOUSER	1990-01-31		sheet 6 of 11	
				engr	C. TREXLER	1990-01-31		size	
				chr	C. TREXLER	1990-01-31		A4	
				appd	C. TREXLER	1990-01-31		type	
sheet index		revision sheet							