

**65043-030LF**

[Assistant](#)

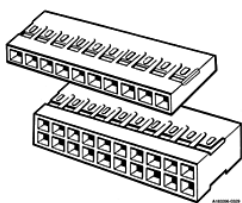

**65043-030LF - Mini-PV™, Basics+**

**2.54 x 2.54 mm (0.1 x 0.1 in.)  
Centerline Crimp-to-Wire PV  
Receptacle Housing, Double Row**

ACTIVE

[Customer Drawing](#)



Electronics division

[Email Datasheet](#)  [Print Datasheet](#)

**FCI Brings You More**

- [Contact our sales/technical support](#)
- [Sample request](#)
- € [Price request](#)
- [Check distributor stock](#)

**Direct Links** ...>

[Cross Reference](#) ✕

[RoHS/LF P/N search](#) 🌿

[Document & Drawing search](#)

[Application tooling](#)

**Services** ...>

[Contact us](#)

[Distributor list](#)

[Pricing request](#)

[Order samples](#)

**Literature** ...>

[Brochures & catalogs](#)

[Product documentation](#)

[Technical library](#)

**Mating Half**



**69168-114HLF2** Wall Shrouded Header -  
Through Hole - Double row - 14  
Positions 2.54 mm - Vertical



**78207-114HLF2** Wall Shrouded Header -  
Through Hole - Double row - 14  
Positions 2.54 mm - Right Angle



**67996-114HLF** Unshrouded header,  
Through Hole, Double row, 14  
Positions, 2.54 mm Pitch, Vertical, 5.84  
mm (0.23 in.) Mating, 2.41 mm (0.095  
in.) Tail



**68020-114HLF** Unshrouded header,  
Through Hole, Double row, 14  
Positions, 2.54 mm Pitch, Right Angle,  
5.84 mm (0.23 in.) Mating, 2.41 mm  
(0.095 in.) Tail

**Download document**

**Technical Resources**

- [> 3D IGES](#)
- [> RoHS qualification documents](#)
- [> Application Specification](#)
- [> 3D STEP](#)
- [> Product Specification](#)
- [> 3D PROE](#)
- [> Application Specification](#)

**Literature**

- [> Basics+ Brochure](#)
- [> Connectors for Medical Devices Brochure](#)
- [> Connector Overview Brochure](#)
- [> Basics+ Product Focus](#)
- [> PV@ Connector system](#)
- [> Contacts & Latch Housings Product Focus](#)

**Application Tooling**

- [> Asia Pacific Application Tooling](#)
- [> Americas Application Tooling](#)
- [> Europe Application Tooling](#)

**Specifications**

General	Dimensional	Electrical	Physical	Approvals / Certifications	Other Features
<b>General</b>					
Number of contacts				14	
Number of rows				2	
Orientation				Vertical	
Product Type				Crimp-to-Wire Housing	
Polarization (Key)				No	
Mating half				Mates with 0.64 mm (0.025 in.) Square Pin with Length of 5.33 mm (0.21 in.) min. to 6.1 mm (0.24 in.) max.	
<b>Dimensional</b>					
Length (Mating pin)				5.33 mm (0.21 in.) to 6.1 mm (0.24 in)	
Size (Wire)				22 to 36 AWG	
<b>Electrical</b>					
Resistance (Insulation)				100000 M ohms	
Voltage rating				1000V rms	
<b>Physical</b>					
Color (Housing)				Black	
Material (Housing)				PPE+PS	
Temperature (Range)				-40°C to +105°C	
<b>Approvals / Certifications</b>					
Approvals / Certifications				UL and CSA Approved	
<b>Other Features</b>					
Accessory				Polarization Plug 65307-001LF	
Packaging (Type)				Bag	
Comments				PV™ Contact Removal Tool: Part Number HT-0080	

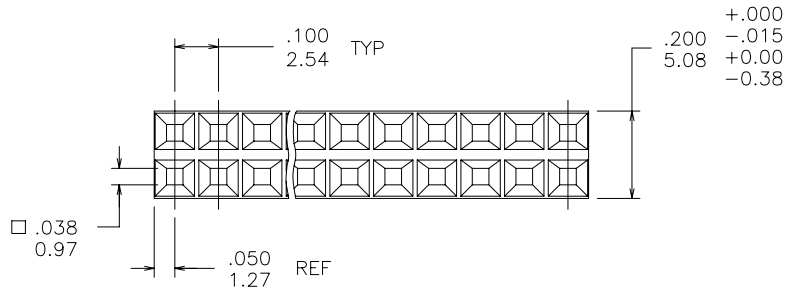
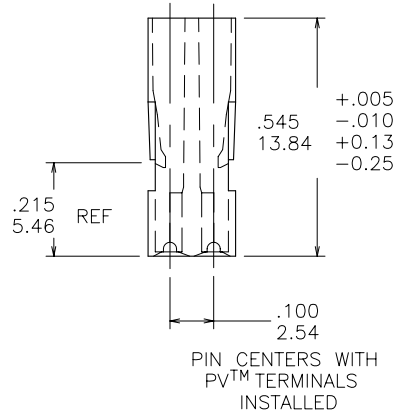
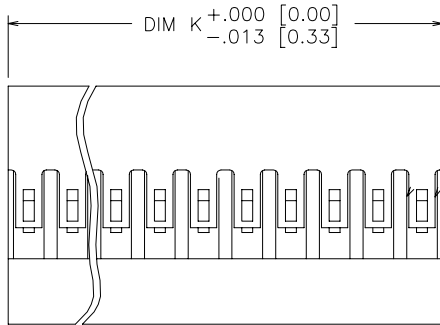

PRODUCT NUMBER  
SEE TABLE



NOTES

- ①. MOLDING MAT'L: MODIFIED POLYPHENYLENE ETHER. COLOR: BLACK, MEETING UL 94V-0.
2. PIN LENGTH TO BE .210/5.33 MIN. RECOMMENDED PIN LENGTH IS .225±.015/5.72±0.38.
3. FOR TERMINAL APPLICATION SEE TA-531.
4. TERMINALS MUST BE CRIMPED PROPERLY FOR SATISFACTORY LATCHING. SEE TA-75 FOR CRIMPING INSTRUCTIONS. PRODUCT SPECIFICATION: BUS-12-067
5. THIS HOUSING IS INTENDED FOR USE WITH MINI PV™ TERMINAL WITH 22-36 GAUGE WIRE.
- ⑥. ALL MARKINGS EXCEPT LOGO USE 6 POINT TYPE (APPROX .06/1.52 HIGH) AND WHITE INK (MARKEM #8829 OR EQUIV.) WHEN MARKING CAVITIES. NUMERALS OR LETTERS ARE TO BE CENTERED ON RESPECTIVE CAVITIES, UNLESS OTHERWISE NOTED.
- ⑦. LOGO TO BE POSITIONED IN THIS AREA SO THAT IT IS READ FROM THE SAME EDGE OF THE CONNECTOR AS THE OTHER MARKINGS.
- ⑧. ALL MARKINGS FOR MILITARY PART NUMBERS ARE TO BE PER MIL-STD-1285 SEE TABULATION.
- ⑨. PLACE DESC P/N AND CAGE NO. ON PACKAGING LABEL. PRODUCT LENGTH IS TOO SMALL TO MARK PRINT.
10. PRODUCT MEETS EUROPEAN UNION DIRECTIVES AND OTHER COUNTRY REGULATIONS AS DESCRIBED IN GS-22-008.
11. THE PRODUCT IS NOT INTENDED TO BE EXPOSED TO MANUFACTURING SOLDER PROCESS.
- ⑫. EUROPEAN CUSTOMERS SHOULD ORDER PART NUMBERS WITH AN 'E' SUFFIX AS SHOWN IN TABLE TO CONTINUE TO BE SUPPLIED BY THE EUROPEAN PLANT. SEE DRAWING 65043EUR.

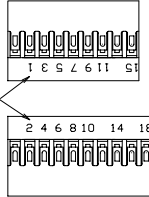
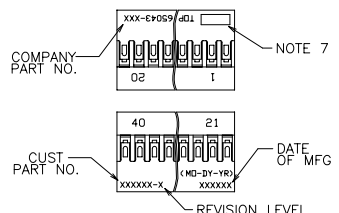
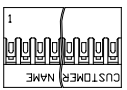
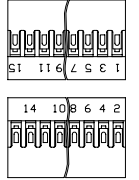
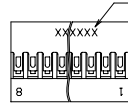
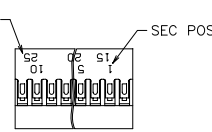
mat'l. code		surface		tolerance		projection		product family	
SEE NOTE 1		ASME Y14.5		ASME Y14.5		INCH/MM		PV HOUSINGS	
ltr	ecn no	dr	date	tolerances unless otherwise specified		INCH/MM		title	
BF	V07-0483	HTB	2007-07-24	angles	XX*01/XX*3	INCH/MM		MINI LATCH HOUSING	
BG	V08-0022	HTB	2008-01-15	lines	XXX*005/XXX*13	scale 2.5:1		DOUBLE ROW .100 [2.54] CC	
-	-	-	-	0°±2'	XXXX*0020/XXX*051			dwg no	
BB	V05-0712	DAI	2005-07-27	dr	M. CLOUSER	1990-01-31		sheet 1 of 11	
BC	V06-0407	HTB	2006-04-27	engr	C. TREXLER	1990-01-31		size	
BD	V06-0549	HTB	2006-06-12	chr	C. TREXLER	1990-01-31		A4	
BE	V06-0886	HTB	2006-08-31	appd	C. TREXLER	1990-01-31		type	
sheet	revision	BG	BG	BG	BG	BG	BG	BG	Product Customer Drawing
index	sheet	1	2	3	4	5	6	7	

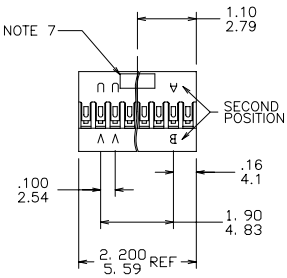
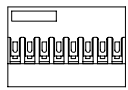
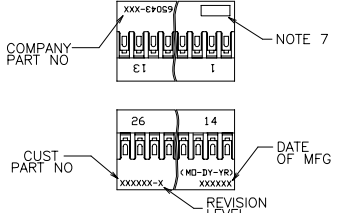
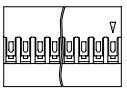
<p>PRODUCT NUMBER SEE TABLE</p>	<p>MARK POSITION NUMBERS AS SHOWN TO LENGTH OF PART.</p>  <p>SECOND POSITION</p>	<p>MARK TOP, CO. LOGO, CUST P/N REV LEVEL, DATE OF MFG, SECOND &amp; NEXT TO LAST POS ON BOTH SIDES IN WHITE AS SHOWN.</p>  <p>COMPANY PART NO.</p> <p>CUST PART NO.</p> <p>NOTE 7</p> <p>DATE OF MFG</p> <p>REVISION LEVEL</p>	
<p>MARK POSITION ONE AND CUST. NAME AS SHOWN.</p>  <p>STYLE A</p>	<p>MARK POSITIONS AS SHOWN.</p>  <p>STYLE D</p> <p>STYLE E</p>	<p>MARK CUST P/N &amp; FIRST &amp; LAST POS (1 SIDE ONLY) AS SHOWN</p>  <p>STYLE H</p>	<p>MARK CAVITIES AS SHOWN.</p>  <p>MARK SECOND CAVITY AS SHOWN.</p>  <p>STYLE K</p> <p>STYLE L</p>
<p>MARK LOGO AND POSITIONS AS SHOWN</p>  <p>NOTE 7</p> <p>1.10 2.79</p> <p>SECOND POSITION</p> <p>.100 2.54</p> <p>.16 4.1</p> <p>1.90 4.83</p> <p>2.200 5.59 REF</p> <p>STYLE B</p>	<p>MARK CUSTOMERS P/N AND REVISION LEVEL IN AREA SHOWN.</p>  <p>STYLE F</p>	<p>MARK TOP, CO. LOGO, CUST P/N REV LEVEL, DATE OF MFG, SECOND &amp; NEXT TO LAST POS ON BOTH SIDES IN WHITE AS SHOWN.</p>  <p>COMPANY PART NO.</p> <p>CUST PART NO.</p> <p>NOTE 7</p> <p>DATE OF MFG</p> <p>REVISION LEVEL</p>	
<p>MARK ARROW IN WHITE AS SHOWN ON SURFACE OPPOSITE GATE.</p>  <p>STYLE C</p>			

mat'l. code		surface		tolerance		projection		product family	
SEE NOTE 1		ASME Y14.5		ASME Y14.5				PV HOUSINGS	
ltr	ecn no	dr	date	tolerances unless otherwise specified					
BG				angles	XX+01/XX+3		INCH/MM		title
					XXX+005/XXX+13		scale 1:1		MINI LATCH HOUSING
				0°±2'	XXXX+0020/XXX+051				DOUBLE ROW .100 [2.54] CC
		dr	M. CLOUSER	1990-01-31					
		engr	C. TREXLER	1990-01-31					
		chr	C. TREXLER	1990-01-31					
		appd	C. TREXLER	1990-01-31					
sheet index	revision sheet								dwg no
									sheet 2 of 11
									size
									A4
									type
									Product Customer Drawing

<p>PRODUCT NUMBER SEE TABLE</p>	<p>MARK CHARACTERS AS SHOWN IN WHITE.(ONE SIDE ONLY)</p> <p>STYLE Q</p>	<p>MARK CHARACTERS ONE SIDE ONLY.</p> <p>STYLE U</p>	
<p>MARK CO. LOGO, CUST P/N AND FIRST &amp; LAST POS PLUS EVERY FOURTH POS IN WHITE AS SHOWN (ONE SIDE ONLY)</p> <p>NOTE: HOUSING WITH 16 POS OR LESS WILL NOT HAVE CO. LOGO INCLUDED.</p> <p>STYLE M</p>	<p>CO. LOGO AND P/N MARKED AS SHOWN. NO CO. P/N ON HOUSING LESS THAN 2 X 8.</p> <p>STYLE R</p>	<p>NUMBER EVERY OTHER POSITION AND SIDE A AND B AS SHOWN.</p> <p>STYLE V</p>	<p>MARK POSITION IDENTIFICATION AS SHOWN.</p> <p>STYLE Y</p>
<p>MARK CAV IDENTIFICATION APPROX AS SHOWN.(ONE SIDE ONLY)</p> <p>STYLE N</p>	<p>MARK CHARACTERS IN WHITE AS SHOWN.</p> <p>STYLE S</p>	<p>MARK POS 1 &amp; 26 CO. LOGO &amp; P/N AS SHOWN SEE NOTE 6.</p> <p>STYLE W</p>	<p>MARK POSITIONS 1, 2 AND 3 ONLY SEE NOTE 6</p> <p>STYLE Z</p>
<p>MARK CAVITY AS SHOWN WITH ARROW.</p> <p>STYLE O</p>	<p>MARK CHARACTERS IN WHITE AS SHOWN.</p> <p>STYLE T</p>		
<p>MARK CHARACTERS AS SHOWN IN WHITE.(ONE SIDE ONLY)</p> <p>SECOND POSITION</p> <p>STYLE P</p>			

mat'l. code SEE NOTE 1		surface ASME Y14.5	tolerance ASME Y14.5	projection 	product family PV HOUSINGS
ltr	ecn no	dr	date	tolerances unless otherwise specified	title MINI LATCH HOUSING DOUBLE ROW .100 [2.54] CC
BG				angles XX*01/XX*3 XXX*005/XXX*13 0'±2'	scale 1:1
				dr M. CLOUSER 1990-01-31	dwg no sheet 3 of 11 size
				engr C. TREXLER 1990-01-31	65043 A4
				chr C. TREXLER 1990-01-31	type Product Customer Drawing
				appd C. TREXLER 1990-01-31	
sheet index	revision sheet				

<p>PRODUCT NUMBER</p> <p>SEE TABLE</p>	<p>MARK FIRST AND LAST POSITION WITH APPROPRIATE NO. ALL EVEN # POSITIONS ON SAME SIDE OF HOUSING</p> <p>STYLE AD</p>	<p>NUMBER EVERY OTHER POSITION AND SIDE A AND B AS SHOWN. MARK CHARACTERS IN WHITE.</p> <p>STYLE AG</p>	<p>MARK "THIS SIDE UP" AND POSITION NUMBERS 13 &amp; 24 AS SHOWN IN .060/1.52 HIGH CHARACTERS.</p> <p>STYLE AK</p>
<p>NUMBER TO BE LOCATED IN CENTER OF RESPECTIVE POSITION</p> <p>STYLE AA</p>	<p>MARK FIRST AND LAST POSITION WITH APPROPRIATE NO. BOTH SIDES ALL EVEN # POSITIONS ON SAME SIDE OF HOUSING</p> <p>STYLE AB</p>	<p>MARK NUMBERS IN WHITE.</p> <p>STYLE AH</p>	<p>MARK FIRST AND LAST POSITION BOTH SIDES AS SHOWN. TO LENGTH OF PART.</p> <p>STYLE AJ</p>
<p>IDENTIFY POSITIONS 1, 6, 13 WITH WHITE CHARACTERS LOCATED AS SHOWN.</p> <p>STYLE AC</p>	<p>MARK HOUSING (ONE SIDE ONLY) EVERY SECOND POSITION WITH ODD NUMBERS TO LENGTH OF PART DO NOT MARK END POSITIONS</p> <p>STYLE AF</p>	<p>MARK FIRST AND LAST POSITION WITH APPROPRIATE NO. ON ONE SIDE, ALSO PRINT "THIS SIDE UP-1" AS SHOWN.</p> <p>STYLE AL</p>	

mat'l. code		surface		tolerance		projection		product family	
SEE NOTE 1		ASME Y14.5		ASME Y14.5				PV HOUSINGS	
ltr	ecn no	dr	date	tolerances unless otherwise specified		INCH/MM		title	
BG				angles	XX*01/X*3			MINI LATCH HOUSING	
				line	XXX*005/XX*13	scale 1:1		DOUBLE ROW .100 [2.54] CC	
					XXXX*0020/XXX*051			dwg no	
		dr	M. CLOUSER	1990-01-31			sheet 4 of 11		size
		engr	C. TREXLER	1990-01-31			65043		A4
		chr	C. TREXLER	1990-01-31			type		Product Customer Drawing
		appd	C. TREXLER	1990-01-31					
sheet index	revision sheet								

PRODUCT NUMBER  
SEE TABLE

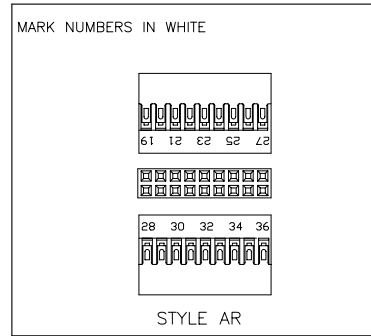
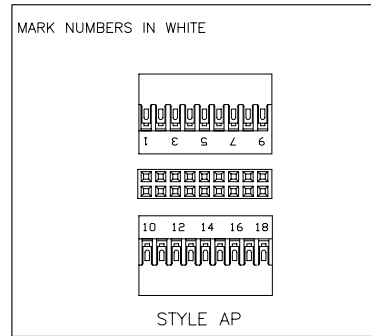
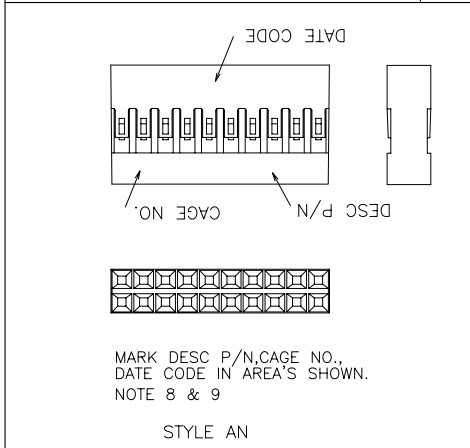
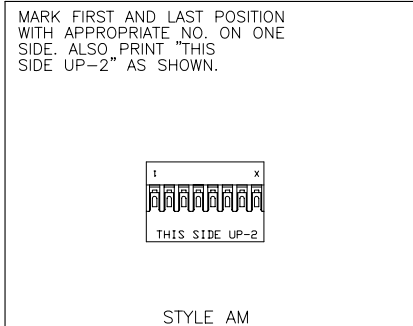

mat'l. code		surface		tolerance		projection		product family	
SEE NOTE 1		ASME Y14.5		ASME Y14.5				PV HOUSINGS	
ltr	ecn no	dr	date	tolerances unless otherwise specified		INCH/MM		title	
BG				angles	.XX+01/XX+3	1:1		MINI LATCH HOUSING	
				linear	XXX+005/XX+13	scale		DOUBLE ROW .100 [2.54] CC	
				0'±2'	XXXX+0020/XXX+051	1:1		dwg no	
				dr	M. CLOUSER	1990-01-31		sheet 5 of 11	
				engr	C. TREXLER	1990-01-31		size	
				chr	C. TREXLER	1990-01-31		A4	
				appd	C. TREXLER	1990-01-31		type	
sheet index		revision sheet						Product Customer Drawing	



PRODUCT NO.	NO OF POS	DIM K	EUROPEAN VERSION-NOTE 12
65043-001LF	2 X 36	3.600/91.44	65043-001ELF
65043-002LF	2 X 35	3.500/88.90	65043-002ELF
65043-003LF	2 X 34	3.400/86.36	65043-003ELF
65043-004LF	2 X 33	3.300/83.82	65043-004ELF
65043-005LF	2 X 32	3.200/81.28	65043-005ELF
65043-006LF	2 X 31	3.100/78.74	65043-006ELF
65043-007LF	2 X 30	3.000/76.20	65043-007ELF
65043-008LF	2 X 29	2.900/73.66	65043-008ELF
65043-009LF	2 X 28	2.800/71.12	65043-009ELF
65043-010LF	2 X 27	2.700/68.58	65043-010ELF
65043-011LF	2 X 26	2.600/66.04	65043-011ELF
65043-012LF	2 X 25	2.500/63.50	65043-012ELF
65043-013LF	2 X 24	2.400/60.96	65043-013ELF
65043-014LF	2 X 23	2.300/58.24	65043-014ELF
65043-015LF	2 X 22	2.200/55.88	65043-015ELF
65043-016LF	2 X 21	2.100/53.34	65043-016ELF
65043-017LF	2 X 20	2.000/50.80	65043-017ELF
65043-018LF	2 X 19	1.900/48.26	65043-018ELF
65043-019LF	2 X 18	1.800/45.72	65043-019ELF
65043-020LF	2 X 17	1.700/43.18	65043-020ELF
65043-021LF	2 X 16	1.600/40.64	65043-021ELF
65043-022LF	2 X 15	1.500/38.10	65043-022ELF
65043-023LF	2 X 14	1.400/35.56	65043-023ELF
65043-024LF	2 X 13	1.300/33.02	65043-024ELF
65043-025LF	2 X 12	1.200/30.48	65043-025ELF
65043-026LF	2 X 11	1.100/27.94	65043-026ELF
65043-027LF	2 X 10	1.000/25.40	65043-027ELF
65043-028LF	2 X 9	.900/22.86	65043-028ELF
65043-029LF	2 X 8	.800/20.32	65043-029ELF
65043-030LF	2 X 7	.700/17.78	65043-030ELF
65043-031LF	2 X 6	.600/15.24	65043-031ELF
65043-032LF	2 X 5	.500/12.70	65043-032ELF
65043-033LF	2 X 4	.400/10.16	65043-033ELF
65043-034LF	2 X 3	.300/7.62	65043-034ELF
65043-035LF	2 X 2	.200/5.08	65043-035ELF

mat'l. code		surface		tolerance		projection		product family	
SEE NOTE 1		ASME Y14.5		ASME Y14.5				PV HOUSINGS	
ltr	ecn no	dr	date	tolerances unless otherwise specified		INCH/MM		title	
BG				angles	linear	scale 1:1		MINI LATCH HOUSING	
				0°±2'	XXXX*0020/XXX*051			DOUBLE ROW .100 [2.54] CC	
		dr	M. CLOUSER	1990-01-31			dwg no		sheet 6 of 11
		engr	C. TREXLER	1990-01-31			65043		size A4
		chr	C. TREXLER	1990-01-31			type		Product Customer Drawing
		appd	C. TREXLER	1990-01-31					
sheet index	revision sheet								